

ACGRAT101L-HF Thru. ACGRAT105L-HF

Glass Passivated Type

Reverse Voltage: 200 to 1000 Volts

Forward Current: 1.0 Amp

RoHS Device

Halogen Free



Features

- Glass passivated cavity-free junction.
- Lead less chip form, no lead damage.
- Low forward voltage drop.
- Plastic package has UL 94V-0.
- Comply with AEC-Q101

Mechanical data

- Case: Packed with FRP substrate and epoxy underfilled.
- Terminals: Pure Tin plated, solderable per MIL-STD-750, method 2026.
- Polarity: Cathode Band, Laser marking.
- Weight: 0.02 grams(approx).

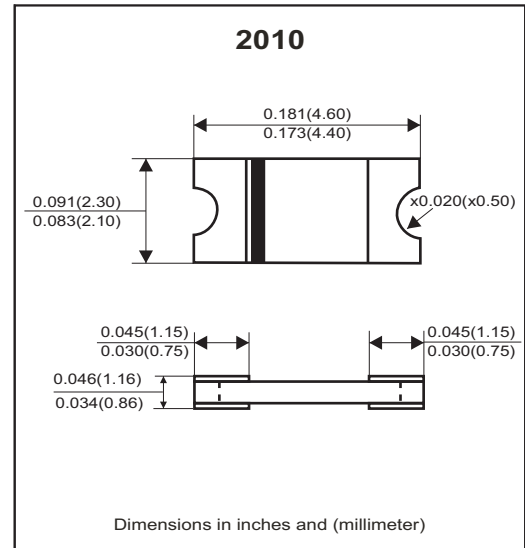

Circuit Diagram



Absolute Maximum Ratings (at Ta=25°C unless otherwise noted)

Parameter	Symbol	ACGRAT 101L-HF	ACGRAT 102L-HF	ACGRAT 103L-HF	ACGRAT 104L-HF	ACGRAT 105L-HF	Units	
Repetitive peak reverse voltage	V_{RRM}	200	400	600	800	1000	V	
Peak forward surge current, 8.3ms single half sine-wave superimposed on rate load (JEDEC method)	I_{FSM}	40						A
Average forward current	$I_{F(AV)}$	1.0						A
Operating junction temperature	T_J	-65 to +175						°C
Storage temperature	T_{STG}	-65 to +175						°C

Electrical Characteristics (at TA=25°C unless otherwise noted)

Parameter	Conditions	Symbol	MIN.	TYP.	MAX.	Unit
Forward voltage	$I_F = 1.0A$	V_F	-	0.91	0.93	V
Repetitive peak reverse current	$V_R = \text{Max. } V_{RRM}, T_A = 25^\circ C$	I_{RRM}	-	0.08	5	uA
Junction capacitance	$V_R = 4V, f = 1.0MHz$	C_J	-	8.2	-	pF
Thermal Resistance	Junction to ambient (Note)	$R_{\theta JA}$	-	70	-	°C/W
	Junction to lead (Note)	$R_{\theta JL}$	-	8	-	

Notes: Thermal resistance from junction to ambient and from junction to lead P.C.B. mounted on 0.2×0.2"(5.0*5.0mm) copper pad areas.

Company reserves the right to improve product design, functions and reliability without notice.

REV: B

RATING AND CHARACTERISTIC CURVES (ACGRAT101L-HF thru ACGRAT105L-HF)

FIG.1 - FORWARD CURRENT DERATING CURVE

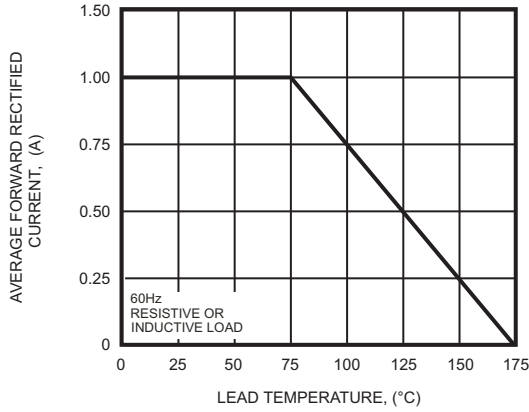

FIG.2 - MAXIMUM NON-REPETITIVE PEAK FORWARD SURGE CURRENT

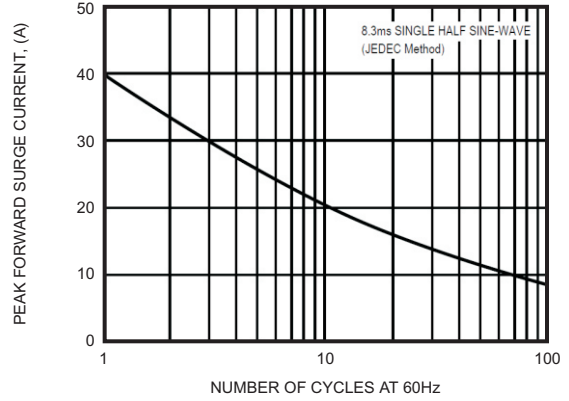

FIG.3 - TYPICAL INSTANTANEOUS FORWARD CHARACTERISTICS

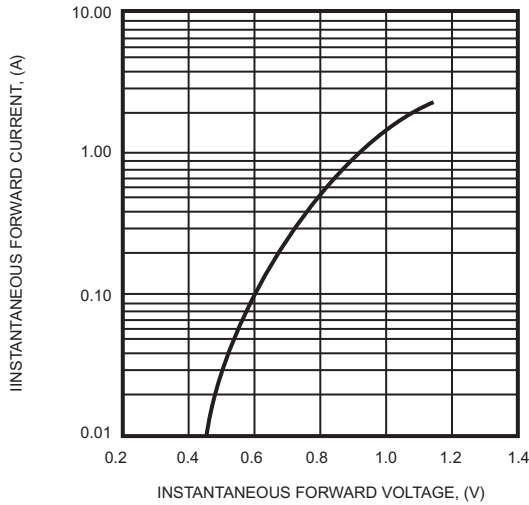

FIG.4 - TYPICAL REVERSE CHARACTERISTICS

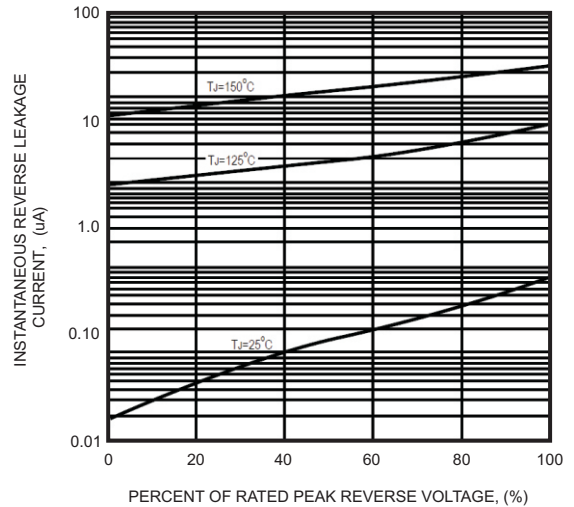
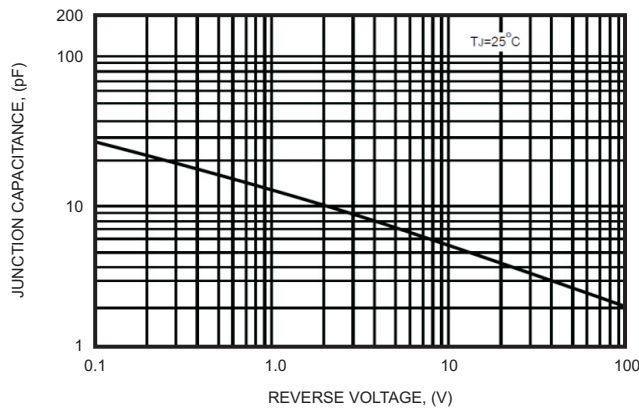
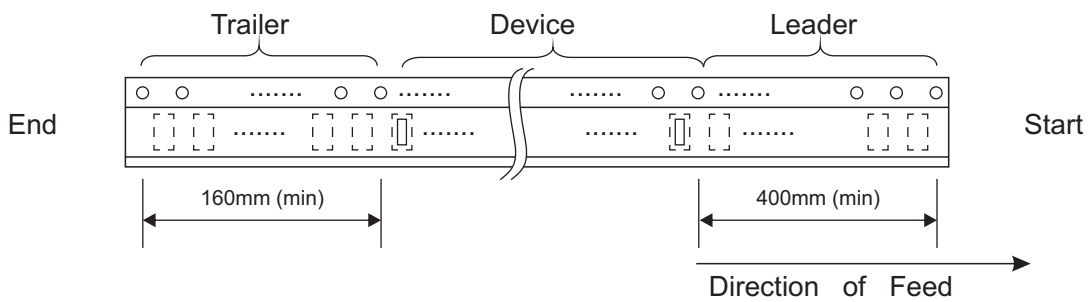
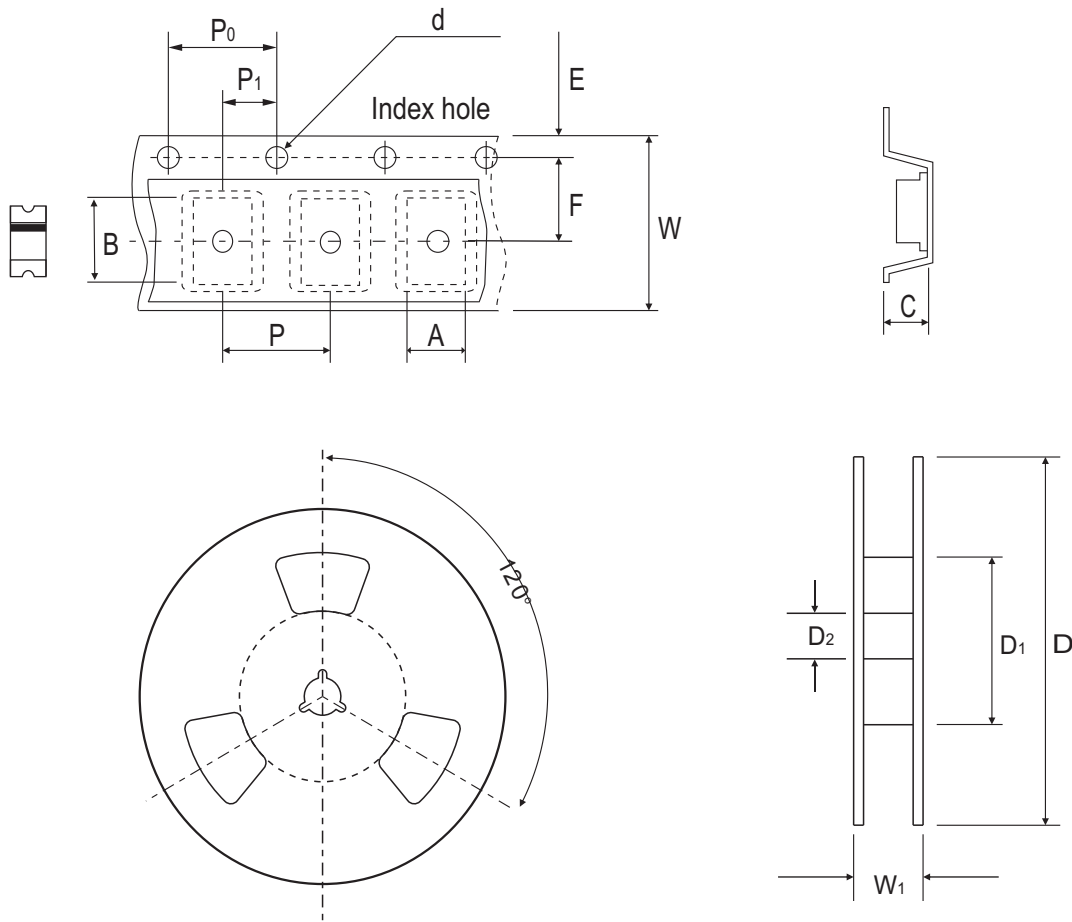

FIG.5 - TYPICAL JUNCTION CAPACITANCE



Reel Taping Specification



2010	SYMBOL	A	B	C	d	D	D ₁	D ₂
	(mm)	4.75 ± 0.10	2.45 ± 0.10	1.30 ± 0.10	1.50 ± 0.10	178.00 ± 2.00	50.00 MIN.	13.00 ± 0.50
	(inch)	0.187 ± 0.004	0.096 ± 0.004	0.051 ± 0.004	0.059 ± 0.004	7.008 ± 0.079	1.969 MIN.	0.512 ± 0.020

2010	SYMBOL	E	F	P	P ₀	P ₁	W	W ₁
	(mm)	1.75 ± 0.10	5.50 ± 0.05	4.00 ± 0.10	4.00 ± 0.10	2.00 ± 0.10	12.00 ± 0.30	18.70 MAX.
	(inch)	0.069 ± 0.004	0.217 ± 0.002	0.157 ± 0.004	0.157 ± 0.004	0.079 ± 0.004	0.472 ± 0.012	0.736 MAX.

Marking Code

Part Number	Marking Code
ACGRAT101L-HF	10D
ACGRAT102L-HF	10G
ACGRAT103L-HF	10J
ACGRAT104L-HF	10K
ACGRAT105L-HF	10M



XXX = Product type marking code

Suggested PAD Layout

SIZE	2010	
	(mm)	(inch)
A	1.47MIN.	0.058MIN.
B	1.27MIN.	0.050MIN.
C	2.60MAX.	0.102MAX.
D	5.14REF.	0.202 REF.

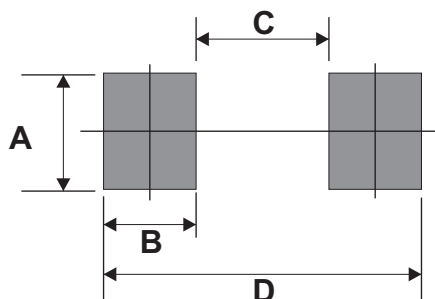

Standard Packaging

Case Type	REEL PACK	
	REEL (pcs)	Reel Size (inch)
2010	3,000	7

Mouser Electronics

Authorized Distributor

Click to View Pricing, Inventory, Delivery & Lifecycle Information:

[Comchip Technology:](#)

[ACGRAT105L-HF](#) [ACGRAT101L-HF](#) [ACGRAT103L-HF](#) [ACGRAT102L-HF](#) [ACGRAT104L-HF](#)