

MBR1240MFS, NRVB1240MFS

Switch-mode Power Rectifiers

Features

- Low Power Loss / High Efficiency
- New Package Provides Capability of Inspection and Probe After Board Mounting
- Guardring for Stress Protection
- Low Forward Voltage Drop
- 150°C Operating Junction Temperature
- Wettable Flasks Option Available
- NRVB Prefix for Automotive and Other Applications Requiring Unique Site and Control Change Requirements; AEC-Q101 Qualified and PPAP Capable

- These are Pb-Free Devices

Mechanical Characteristics:

- Case: Epoxy, Molded
- Epoxy Meets Flammability Rating UL 94-0 @ 0.125 in.
- Lead Finish: 100% Matte Sn (Tin)
- Lead and Mounting Surface Temperature for Soldering Purposes: 260°C Max. for 10 Seconds
- Device Meets MSL 1 Requirements

MAXIMUM RATINGS

Rating	Symbol	Value	Unit
Peak Repetitive Reverse Voltage Working Peak Reverse Voltage DC Blocking Voltage	V_{RRM} V_{RWM} V_R	40	V
Average Rectified Forward Current (Rated V_R , $T_C = 140^\circ\text{C}$)	$I_{F(AV)}$	12	A
Peak Repetitive Forward Current, (Rated V_R , Square Wave, 20 kHz, $T_C = 138^\circ\text{C}$)	I_{FRM}	20	A
Non-Repetitive Peak Surge Current (Surge Applied at Rated Load Conditions Halfwave, Single Phase, 60 Hz)	I_{FSM}	150	A
Storage Temperature Range	T_{stg}	-65 to +175	°C
Operating Junction Temperature	T_J	-55 to +150	°C
Unclamped Inductive Switching Energy (10 mH Inductor, Non-repetitive)	E_{AS}	150	mJ
ESD Rating (Human Body Model)		3B	
ESD Rating (Machine Model)		M4	

Stresses exceeding Maximum Ratings may damage the device. Maximum Ratings are stress ratings only. Functional operation above the Recommended Operating Conditions is not implied. Extended exposure to stresses above the Recommended Operating Conditions may affect device reliability.

NOTE: The heat generated must be less than the thermal conductivity from Junction-to-Ambient: $dPD/dT_J < 1/R_{JA}$.



ON Semiconductor®

<http://onsemi.com>

SCHOTTKY BARRIER RECTIFIERS 12 AMPERES 40 VOLTS

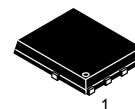
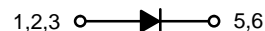

SO-8 FLAT LEAD
CASE 488AA
STYLE 2

MARKING DIAGRAM

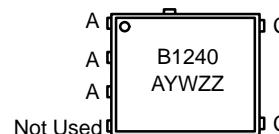

B1240 = Specific Device Code
A = Assembly Location
Y = Year
W = Work Week
ZZ = Lot Traceability

ORDERING INFORMATION

Device	Package	Shipping†
MBR1240MFST1G	SO-8 FL (Pb-Free)	1500 / Tape & Reel
MBR1240MFST3G	SO-8 FL (Pb-Free)	5000 / Tape & Reel
NRVB1240MFST1G	SO-8 FL (Pb-Free)	1500 / Tape & Reel
NRVB1240MFST3G	SO-8 FL (Pb-Free)	5000 / Tape & Reel

†For information on tape and reel specifications, including part orientation and tape sizes, please refer to our Tape and Reel Packaging Specification Brochure, BRD8011/D.

MBR1240MFS, NRVB1240MFS

THERMAL CHARACTERISTICS

Characteristic	Symbol	Typ	Max	Unit
Thermal Resistance, Junction-to-Case, Steady State (Assumes 600 mm ² 1 oz. copper bond pad, on a FR4 board)	$R_{\theta JC}$	-	1.7	°C/W

ELECTRICAL CHARACTERISTICS

Instantaneous Forward Voltage (Note 1) ($i_F = 12$ A, $T_J = 125^\circ\text{C}$) ($i_F = 12$ A, $T_J = 25^\circ\text{C}$)	V_F	0.455	0.62	V
		0.53	0.68	
Instantaneous Reverse Current (Note 1) (Rated dc Voltage, $T_J = 125^\circ\text{C}$) (Rated dc Voltage, $T_J = 25^\circ\text{C}$)	i_R	35	170	mA
		0.08	0.5	

1. Pulse Test: Pulse Width = 300 μs , Duty Cycle $\leq 2.0\%$.

MBR1240MFS, NRVB1240MFS

TYPICAL CHARACTERISTICS

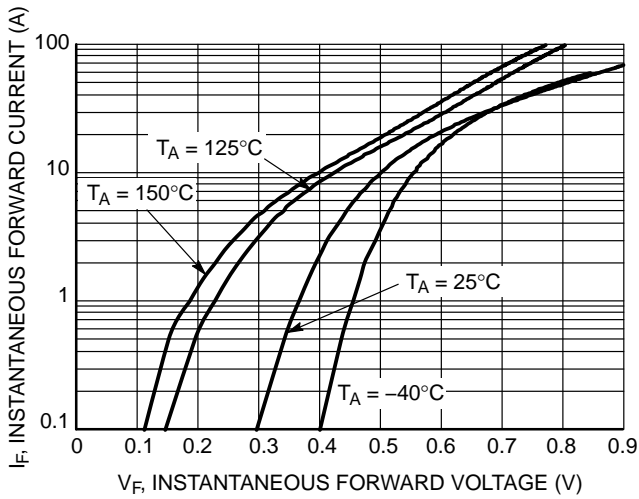

Figure 1. Typical Instantaneous Forward Characteristics

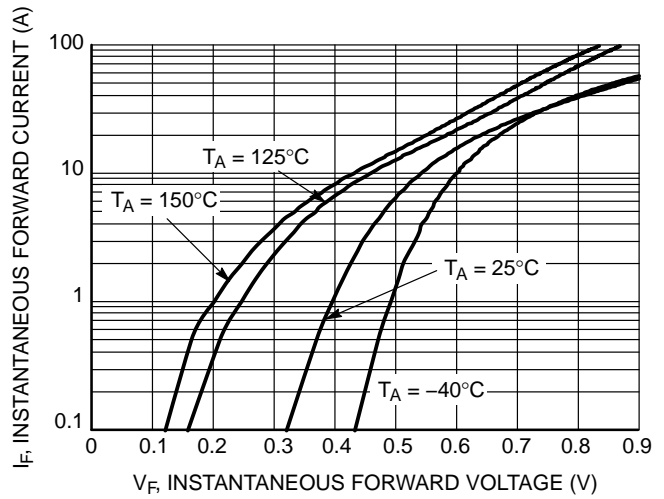

Figure 2. Maximum Instantaneous Forward Characteristics

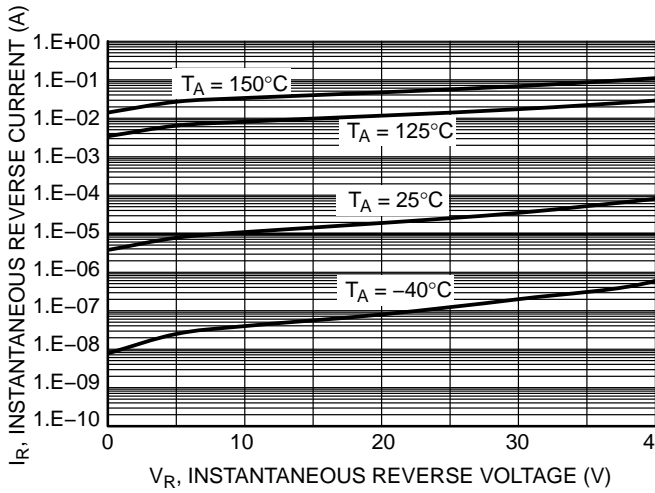

Figure 3. Typical Reverse Characteristics

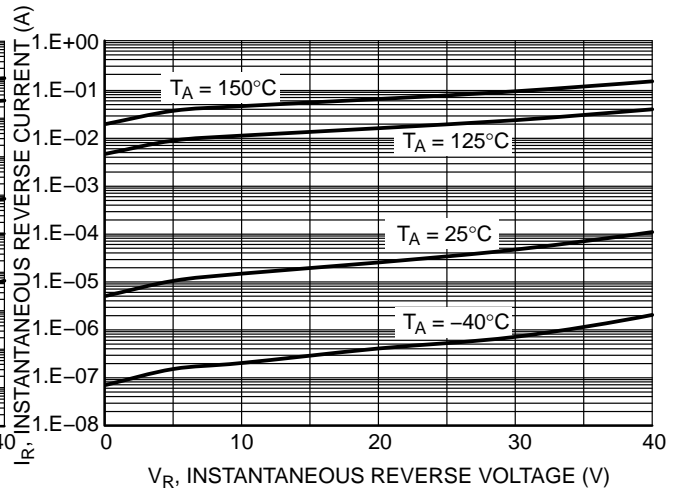

Figure 4. Maximum Reverse Characteristics

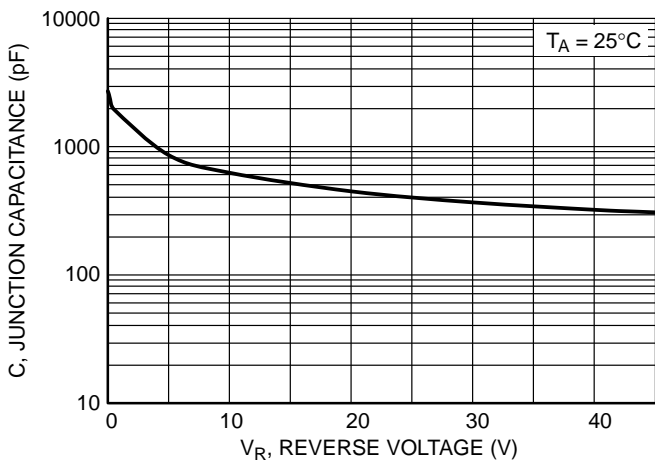

Figure 5. Typical Junction Characteristics

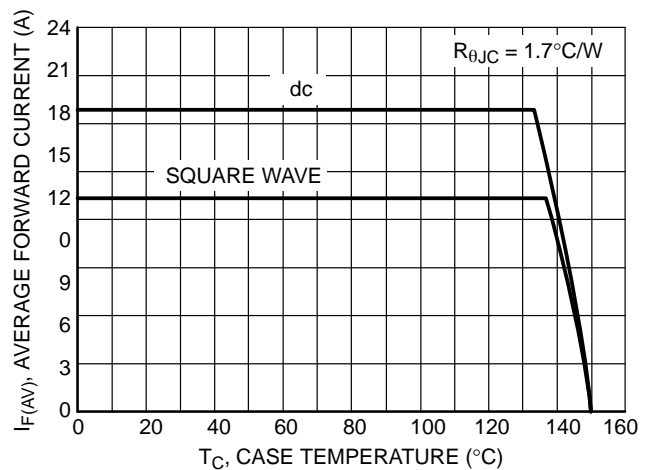

Figure 6. Current Derating TO-220AB

MBR1240MFS, NRVB1240MFS

TYPICAL CHARACTERISTICS

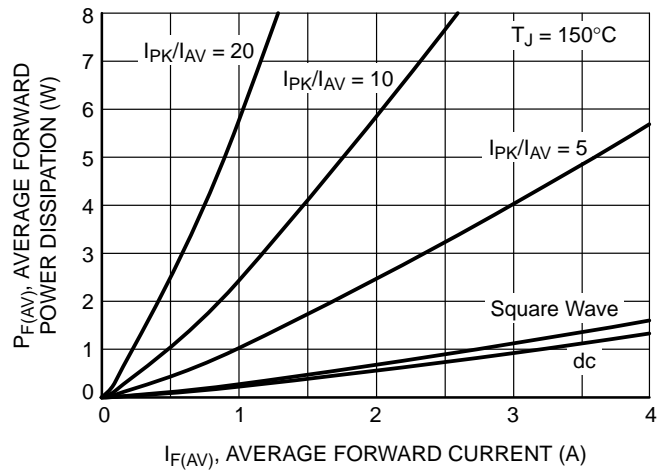

Figure 7. Forward Power Dissipation

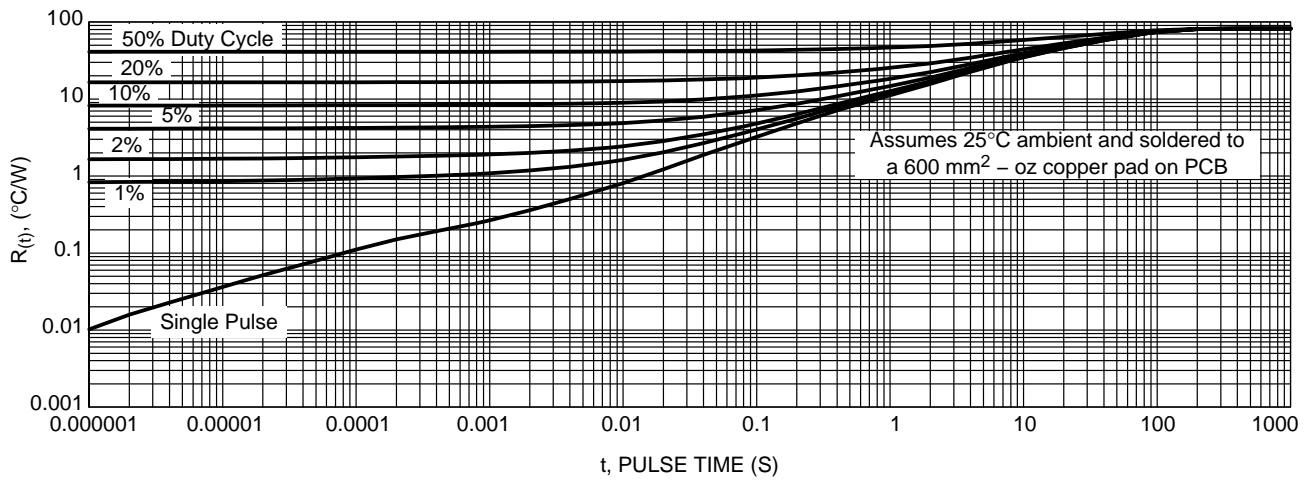
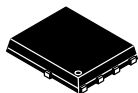

Figure 8. $R_{\theta(t)}$ vs. Duty

MECHANICAL CASE OUTLINE

PACKAGE DIMENSIONS

ON Semiconductor®



1
SCALE 2:1

DFN5 5x6, 1.27P
(SO-8FL)
CASE 488AA
ISSUE N

DATE 25 JUN 2018

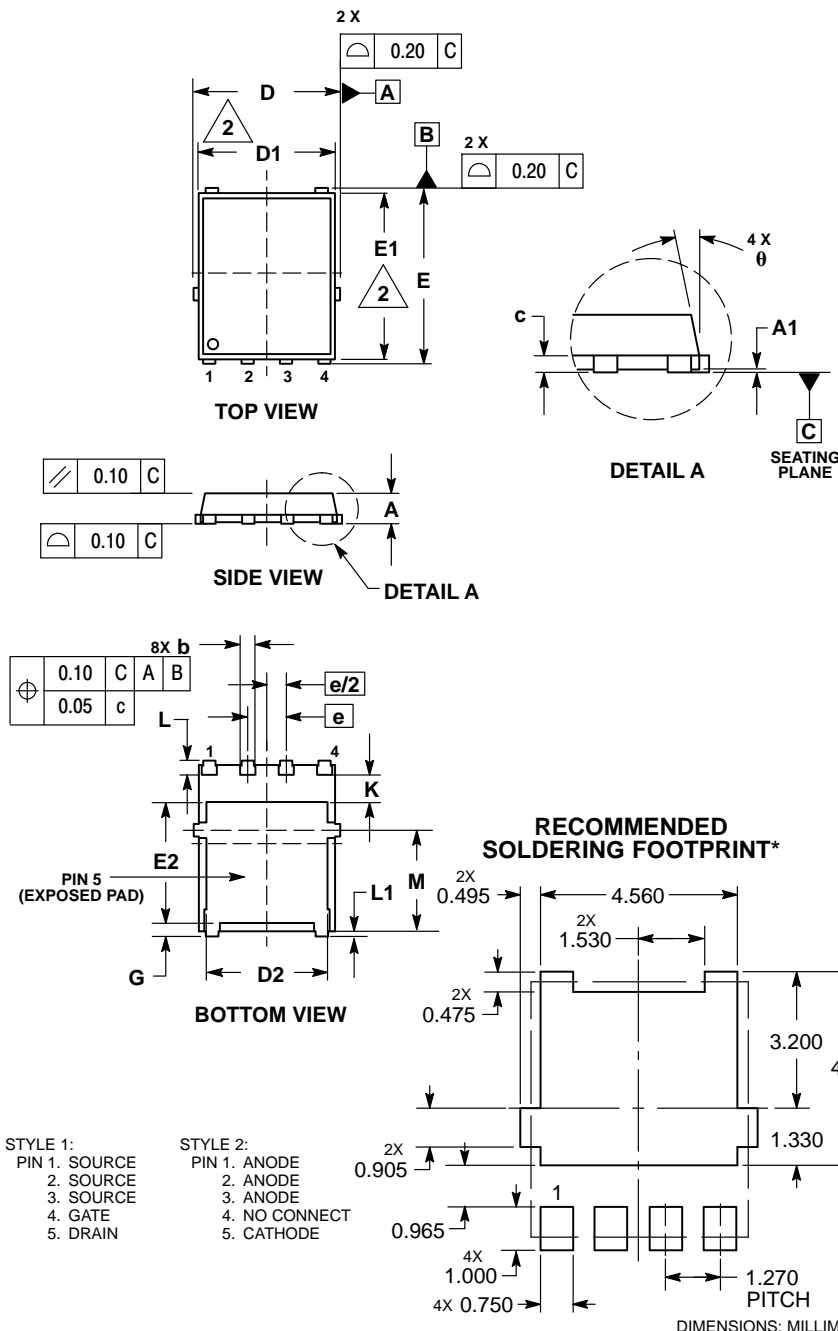

- NOTES:
1. DIMENSIONING AND TOLERANCING PER ASME Y14.5M, 1994.
 2. CONTROLLING DIMENSION: MILLIMETER.
 3. DIMENSION D1 AND E1 DO NOT INCLUDE MOLD FLASH PROTRUSIONS OR GATE BURRS.

DIM	MILLIMETERS		
	MIN	NOM	MAX
A	0.90	1.00	1.10
A1	0.00	---	0.05
b	0.33	0.41	0.51
c	0.23	0.28	0.33
D	5.00	5.15	5.30
D1	4.70	4.90	5.10
D2	3.80	4.00	4.20
E	6.00	6.15	6.30
E1	5.70	5.90	6.10
E2	3.45	3.65	3.85
e	1.27 BSC		
G	0.51	0.575	0.71
K	1.20	1.35	1.50
L	0.51	0.575	0.71
L1	0.125 REF		
M	3.00	3.40	3.80
θ	0°	---	12°

GENERIC MARKING DIAGRAM*

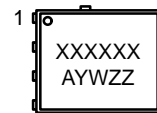

- XXXXXX = Specific Device Code
- A = Assembly Location
- Y = Year
- W = Work Week
- ZZ = Lot Traceability

*This information is generic. Please refer to device data sheet for actual part marking. Pb-Free indicator, "G" or microdot "•", may or may not be present. Some products may not follow the Generic Marking.

- STYLE 1:
PIN 1. SOURCE
2. SOURCE
3. SOURCE
4. GATE
5. DRAIN
- STYLE 2:
PIN 1. ANODE
2. ANODE
3. ANODE
4. NO CONNECT
5. CATHODE

*For additional information on our Pb-Free strategy and soldering details, please download the ON Semiconductor Soldering and Mounting Techniques Reference Manual, SOLDERRM/D.

DOCUMENT NUMBER:	98AON14036D	Electronic versions are uncontrolled except when accessed directly from the Document Repository. Printed versions are uncontrolled except when stamped "CONTROLLED COPY" in red.
DESCRIPTION:	DFN5 5x6, 1.27P (SO-8FL)	PAGE 1 OF 1

ON Semiconductor and ON are trademarks of Semiconductor Components Industries, LLC dba ON Semiconductor or its subsidiaries in the United States and/or other countries. ON Semiconductor reserves the right to make changes without further notice to any products herein. ON Semiconductor makes no warranty, representation or guarantee regarding the suitability of its products for any particular purpose, nor does ON Semiconductor assume any liability arising out of the application or use of any product or circuit, and specifically disclaims any and all liability, including without limitation special, consequential or incidental damages. ON Semiconductor does not convey any license under its patent rights nor the rights of others.

onsemi, **Onsemi**, and other names, marks, and brands are registered and/or common law trademarks of Semiconductor Components Industries, LLC dba "**onsemi**" or its affiliates and/or subsidiaries in the United States and/or other countries. **onsemi** owns the rights to a number of patents, trademarks, copyrights, trade secrets, and other intellectual property. A listing of **onsemi**'s product/patent coverage may be accessed at www.onsemi.com/site/pdf/Patent-Marking.pdf. **onsemi** reserves the right to make changes at any time to any products or information herein, without notice. The information herein is provided "as-is" and **onsemi** makes no warranty, representation or guarantee regarding the accuracy of the information, product features, availability, functionality, or suitability of its products for any particular purpose, nor does **onsemi** assume any liability arising out of the application or use of any product or circuit, and specifically disclaims any and all liability, including without limitation special, consequential or incidental damages. Buyer is responsible for its products and applications using **onsemi** products, including compliance with all laws, regulations and safety requirements or standards, regardless of any support or applications information provided by **onsemi**. "Typical" parameters which may be provided in **onsemi** data sheets and/or specifications can and do vary in different applications and actual performance may vary over time. All operating parameters, including "Typicals" must be validated for each customer application by customer's technical experts. **onsemi** does not convey any license under any of its intellectual property rights nor the rights of others. **onsemi** products are not designed, intended, or authorized for use as a critical component in life support systems or any FDA Class 3 medical devices or medical devices with a same or similar classification in a foreign jurisdiction or any devices intended for implantation in the human body. Should Buyer purchase or use **onsemi** products for any such unintended or unauthorized application, Buyer shall indemnify and hold **onsemi** and its officers, employees, subsidiaries, affiliates, and distributors harmless against all claims, costs, damages, and expenses, and reasonable attorney fees arising out of, directly or indirectly, any claim of personal injury or death associated with such unintended or unauthorized use, even if such claim alleges that **onsemi** was negligent regarding the design or manufacture of the part. **onsemi** is an Equal Opportunity/Affirmative Action Employer. This literature is subject to all applicable copyright laws and is not for resale in any manner.

PUBLICATION ORDERING INFORMATION

LITERATURE FULFILLMENT:

Email Requests to: orderlit@onsemi.com

onsemi Website: www.onsemi.com

TECHNICAL SUPPORT

North American Technical Support:

Voice Mail: 1 800-282-9855 Toll Free USA/Canada

Phone: 011 421 33 790 2910

Europe, Middle East and Africa Technical Support:

Phone: 00421 33 790 2910

For additional information, please contact your local Sales Representative