

# NTD2955, NVD2955

## MOSFET – Power, P-Channel, DPAK

**-60 V, -12 A**

This Power MOSFET is designed to withstand high energy in the avalanche and commutation modes. Designed for low-voltage, high-speed switching applications in power supplies, converters, and power motor controls. These devices are particularly well suited for bridge circuits where diode speed and commutating safe operating areas are critical and offer an additional safety margin against unexpected voltage transients.

### Features

- Avalanche Energy Specified
- $I_{DSS}$  and  $V_{DS(on)}$  Specified at Elevated Temperature
- Designed for Low-Voltage, High-Speed Switching Applications and to Withstand High Energy in the Avalanche and Commutation Modes
- NVD and SVD Prefix for Automotive and Other Applications Requiring Unique Site and Control Change Requirements; AEC-Q101 Qualified and PPAP Capable
- These Devices are Pb-Free and are RoHS Compliant

### MAXIMUM RATINGS ( $T_J = 25^\circ\text{C}$ unless otherwise noted)

Rating	Symbol	Value	Unit
Drain-to-Source Voltage	$V_{DSS}$	-60	Vdc
Gate-to-Source Voltage	$V_{GS}$	$\pm 20$	Vdc
- Continuous	$V_{GSM}$	$\pm 25$	Vpk
- Non-repetitive ( $t_p \leq 10$ ms)			
Drain Current	$I_D$	-12	Adc
- Continuous @ $T_a = 25^\circ\text{C}$	$I_{DM}$	-18	Apk
- Single Pulse ( $t_p \leq 10$ ms)			
Total Power Dissipation @ $T_a = 25^\circ\text{C}$	$P_D$	55	W
Operating and Storage Temperature Range	$T_J, T_{stg}$	-55 to 175	$^\circ\text{C}$
Single Pulse Drain-to-Source Avalanche Energy – Starting $T_J = 25^\circ\text{C}$ ( $V_{DD} = 25$ Vdc, $V_{GS} = 10$ Vdc, Peak $I_L = 12$ Apk, $L = 3.0$ mH, $R_G = 25$ $\Omega$ )	$E_{AS}$	216	mJ
Thermal Resistance	$R_{\theta JC}$	2.73	$^\circ\text{C/W}$
- Junction-to-Case	$R_{\theta JA}$	71.4	
- Junction-to-Ambient (Note 1)	$R_{\theta JA}$	100	
- Junction-to-Ambient (Note 2)			
Maximum Lead Temperature for Soldering Purposes, 1/8 in. from case for 10 seconds	$T_L$	260	$^\circ\text{C}$

Stresses exceeding those listed in the Maximum Ratings table may damage the device. If any of these limits are exceeded, device functionality should not be assumed, damage may occur and reliability may be affected.

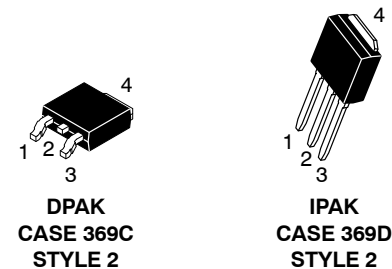
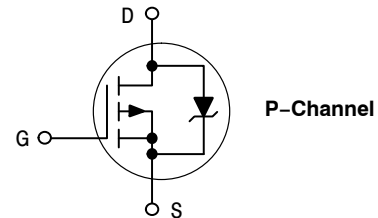
1. When surface mounted to an FR4 board using 1 in pad size (Cu area = 1.127 in<sup>2</sup>).
2. When surface mounted to an FR4 board using the minimum recommended pad size (Cu area = 0.412 in<sup>2</sup>).



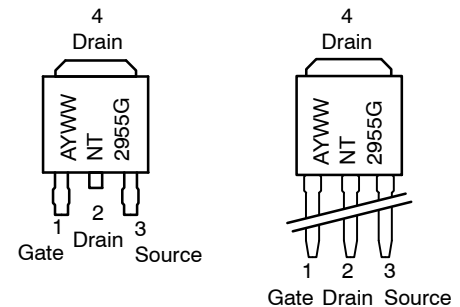
**ON Semiconductor®**

[www.onsemi.com](http://www.onsemi.com)

$V_{(BR)DSS}$	$R_{DS(on)}$ TYP	$I_D$ MAX
-60 V	155 m $\Omega$ @ -10 V, 6 A	-12 A



### MARKING DIAGRAMS & PIN ASSIGNMENTS



A = Assembly Location\*  
 NT2955/NV2955 = Specific Device Code (DPAK)  
 NT2955 = Specific Device Code (IPAK)  
 Y = Year  
 WW = Work Week  
 G = Pb-Free Package

\* The Assembly Location code (A) is front side optional. In cases where the Assembly Location is stamped in the package, the front side assembly code may be blank.

### ORDERING INFORMATION

See detailed ordering and shipping information on page 5 of this data sheet.

# NTD2955, NVD2955

## ELECTRICAL CHARACTERISTICS (T<sub>J</sub> = 25°C unless otherwise noted)

Characteristic	Symbol	Min	Typ	Max	Unit
----------------	--------	-----	-----	-----	------

### OFF CHARACTERISTICS

Drain-to-Source Breakdown Voltage (Note 3) (V <sub>GS</sub> = 0 Vdc, I <sub>D</sub> = -0.25 mA) (Positive Temperature Coefficient)	V <sub>(BR)DSS</sub>	-60 -	- 67	- -	Vdc mV/°C
Zero Gate Voltage Drain Current (V <sub>GS</sub> = 0 Vdc, V <sub>DS</sub> = -60 Vdc, T <sub>J</sub> = 25°C) (V <sub>GS</sub> = 0 Vdc, V <sub>DS</sub> = -60 Vdc, T <sub>J</sub> = 150°C)	I <sub>DSS</sub>	- -	- -	-10 -100	μAdc
Gate-Body Leakage Current (V <sub>GS</sub> = ± 20 Vdc, V <sub>DS</sub> = 0 Vdc)	I <sub>GSS</sub>	-	-	-100	nAdc

### ON CHARACTERISTICS (Note 3)

Gate Threshold Voltage (V <sub>DS</sub> = V <sub>GS</sub> , I <sub>D</sub> = -250 μAdc) (Negative Temperature Coefficient)	V <sub>GS(th)</sub>	-2.0 -	-2.8 4.5	-4.0 -	Vdc mV/°C
Static Drain-Source On-State Resistance (V <sub>GS</sub> = -10 Vdc, I <sub>D</sub> = -6.0 Adc)	R <sub>DS(on)</sub>	-	0.155	0.180	Ω
Drain-to-Source On-Voltage (V <sub>GS</sub> = -10 Vdc, I <sub>D</sub> = -12 Adc) (V <sub>GS</sub> = -10 Vdc, I <sub>D</sub> = -6.0 Adc, T <sub>J</sub> = 150°C)	V <sub>DS(on)</sub>		-1.86 -	-2.6 -2.0	Vdc
Forward Transconductance (V <sub>DS</sub> = 10 Vdc, I <sub>D</sub> = 6.0 Adc)	g <sub>FS</sub>		8.0	-	Mhos

### DYNAMIC CHARACTERISTICS

Input Capacitance	(V <sub>DS</sub> = -25 Vdc, V <sub>GS</sub> = 0 Vdc, F = 1.0 MHz)	C <sub>iSS</sub>	-	500	750	pF
Output Capacitance		C <sub>oSS</sub>	-	150	250	
Reverse Transfer Capacitance		C <sub>rSS</sub>	-	50	100	

### SWITCHING CHARACTERISTICS (Notes 3 and 4)

Turn-On Delay Time	(V <sub>DD</sub> = -30 Vdc, I <sub>D</sub> = -12 A, V <sub>GS</sub> = -10 V, R <sub>G</sub> = 9.1 Ω)	t <sub>d(on)</sub>	-	10	20	ns
Rise Time		t <sub>r</sub>	-	45	85	
Turn-Off Delay Time		t <sub>d(off)</sub>	-	26	40	
Fall Time		t <sub>f</sub>	-	48	90	
Gate Charge	(V <sub>DS</sub> = -48 Vdc, V <sub>GS</sub> = -10 Vdc, I <sub>D</sub> = -12 A)	Q <sub>T</sub>	-	15	30	nC
		Q <sub>GS</sub>	-	4.0	-	
		Q <sub>GD</sub>	-	7.0	-	

### DRAIN-SOURCE DIODE CHARACTERISTICS (Note 3)

Diode Forward On-Voltage (I <sub>S</sub> = 12 Adc, V <sub>GS</sub> = 0 V) (I <sub>S</sub> = 12 Adc, V <sub>GS</sub> = 0 V, T <sub>J</sub> = 150°C)	V <sub>SD</sub>	- -	-1.6 -1.3	-2.5 -	Vdc
Reverse Recovery Time (I <sub>S</sub> = 12 A, di <sub>S</sub> /dt = 100 A/μs, V <sub>GS</sub> = 0 V)	t <sub>rr</sub>	-	50		ns
	t <sub>a</sub>	-	40	-	
	t <sub>b</sub>	-	10	-	
Reverse Recovery Stored Charge	Q <sub>RR</sub>	-	0.10	-	μC

Product parametric performance is indicated in the Electrical Characteristics for the listed test conditions, unless otherwise noted. Product performance may not be indicated by the Electrical Characteristics if operated under different conditions.

3. Indicates Pulse Test: Pulse Width ≤ 300 μs, Duty Cycle ≤ 2%.

4. Switching characteristics are independent of operating junction temperature.

# NTD2955, NVD2955

## TYPICAL PERFORMANCE CURVES ( $T_J = 25^\circ\text{C}$ unless otherwise noted)

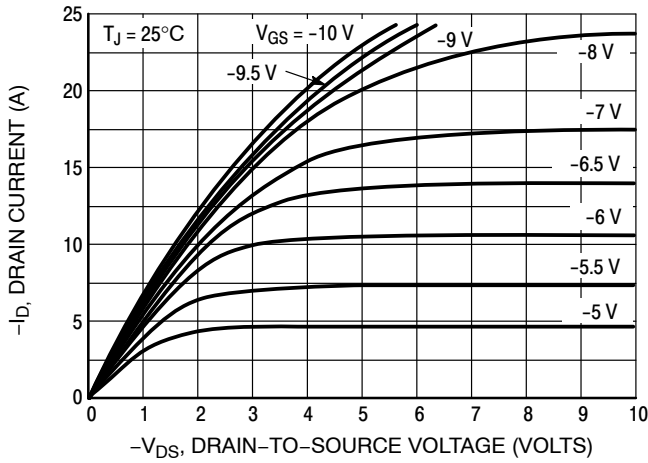


Figure 1. On-Region Characteristics

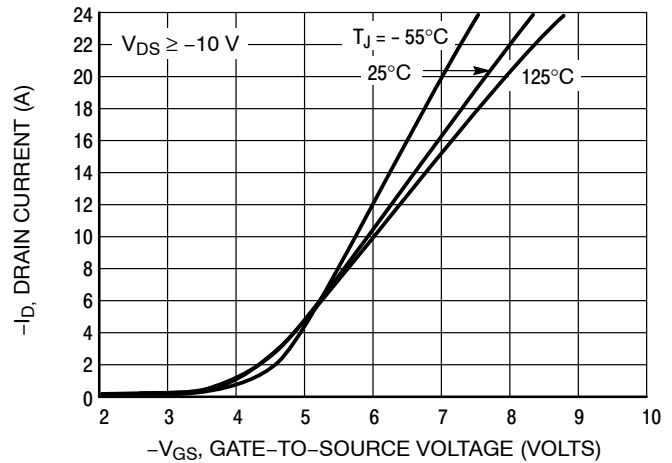


Figure 2. Transfer Characteristics

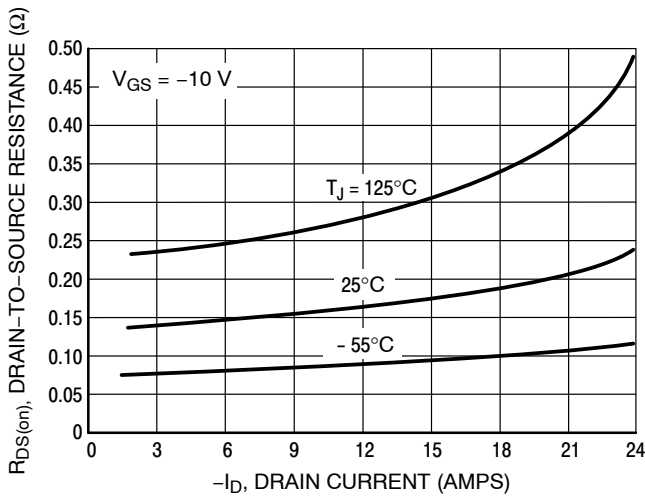


Figure 3. On-Resistance versus Drain Current and Temperature

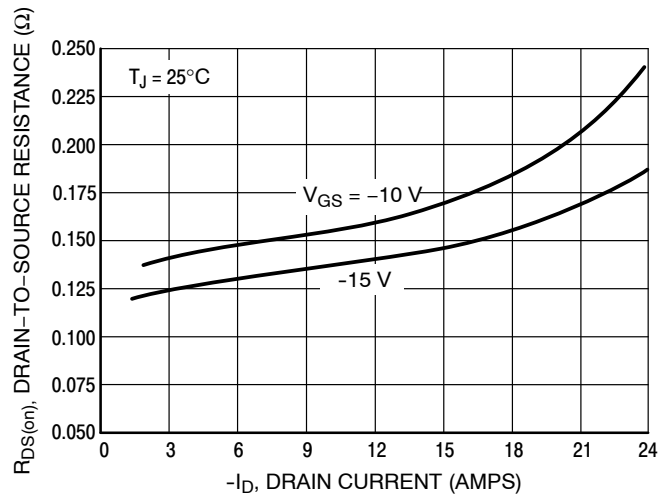


Figure 4. On-Resistance versus Drain Current and Gate Voltage

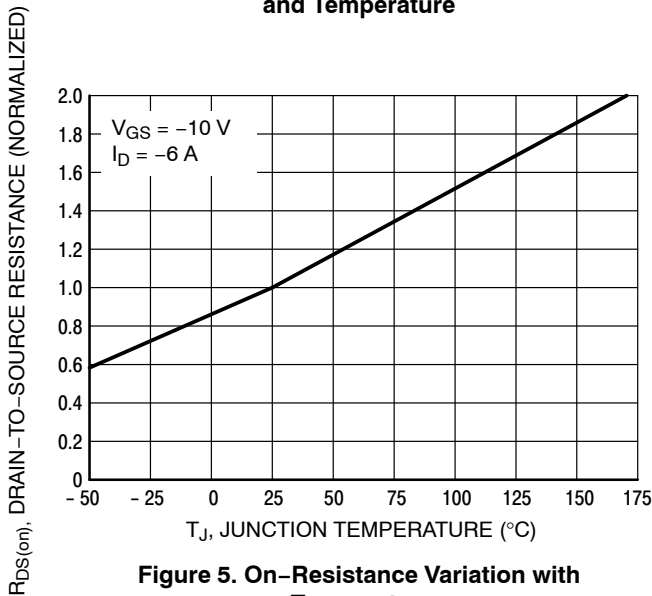


Figure 5. On-Resistance Variation with Temperature

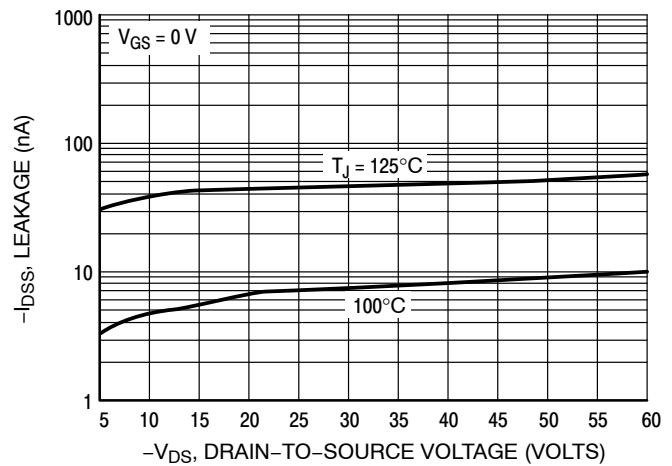
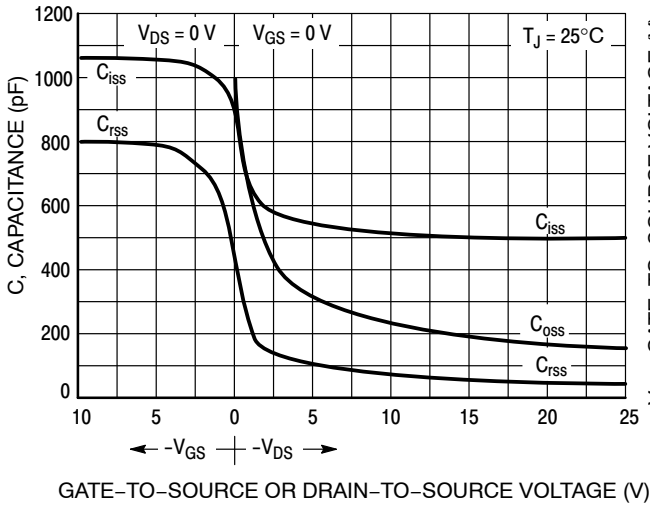
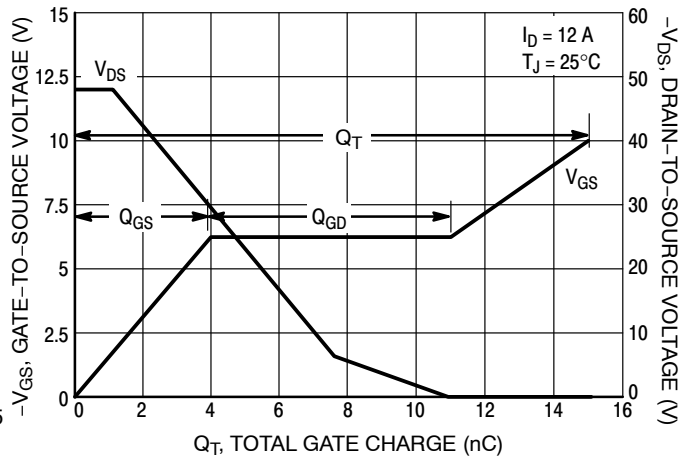


Figure 6. Drain-To-Source Leakage Current versus Voltage

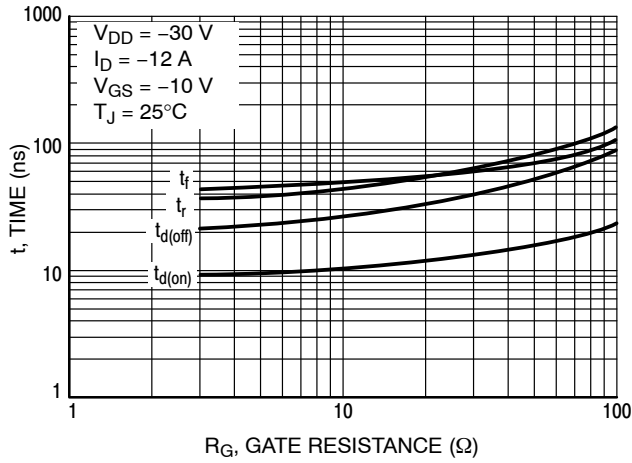
# NTD2955, NVD2955



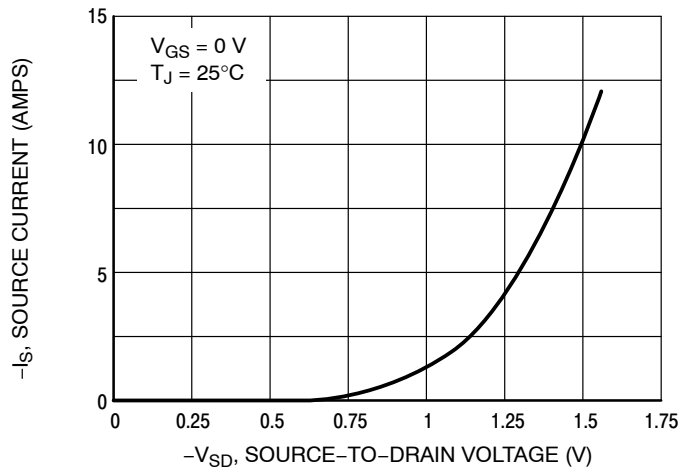
**Figure 7. Capacitance Variation**



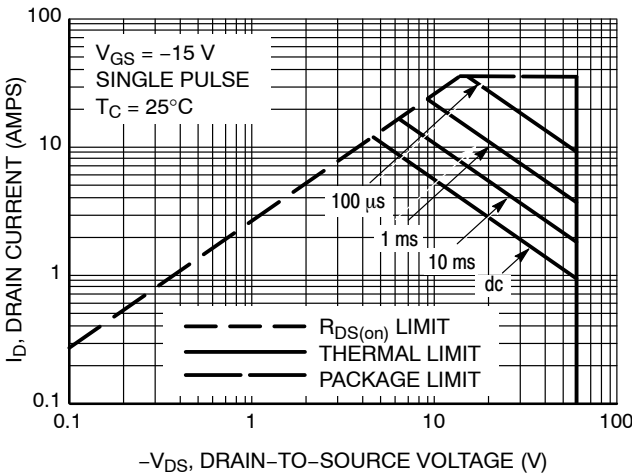
**Figure 8. Gate-To-Source and Drain-To-Source Voltage versus Total Charge**



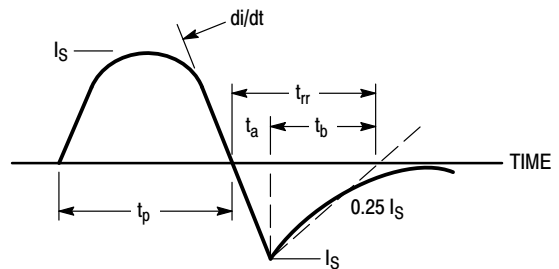
**Figure 9. Resistive Switching Time Variation versus Gate Resistance**



**Figure 10. Diode Forward Voltage versus Current**

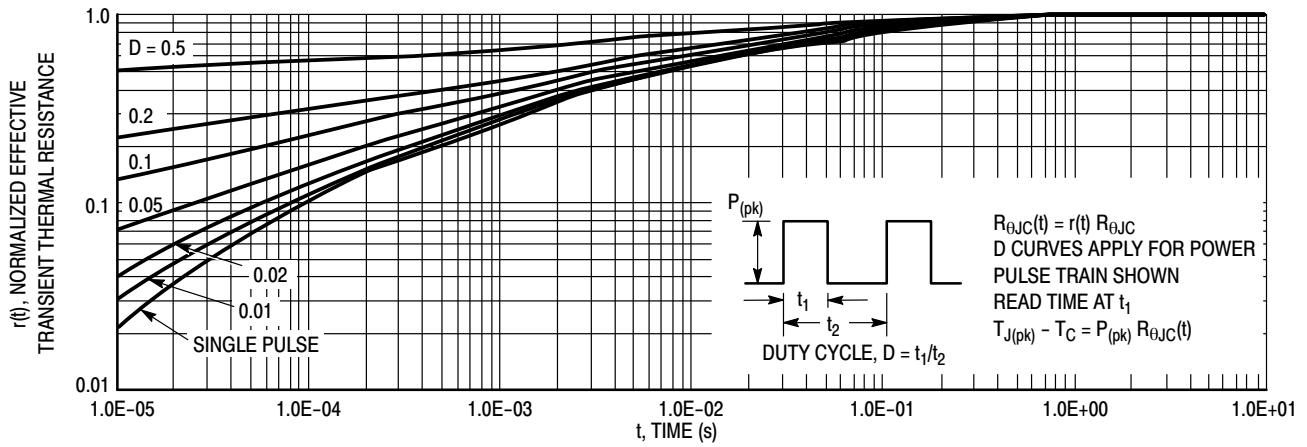


**Figure 11. Maximum Rated Forward Biased Safe Operating Area**



**Figure 12. Diode Reverse Recovery Waveform**

## NTD2955, NVD2955



**Figure 13. Thermal Response**

### ORDERING INFORMATION

Device	Package	Shipping <sup>†</sup>
NTD2955G	DPAK (Pb-Free)	75 Units / Rail
NTD2955-1G	IPAK (Pb-Free)	75 Units / Rail
NTD2955T4G	DPAK (Pb-Free)	2500 / Tape & Reel
NVD2955T4G*	DPAK (Pb-Free)	2500 / Tape & Reel
SVD2955T4G*	DPAK (Pb-Free)	2500 / Tape & Reel

<sup>†</sup>For information on tape and reel specifications, including part orientation and tape sizes, please refer to our Tape and Reel Packaging Specifications Brochure, BRD8011/D.

\*NVD and SVD Prefix for Automotive and Other Applications Requiring Unique Site and Control Change Requirements; AEC-Q101 Qualified and PPAP Capable.

# MECHANICAL CASE OUTLINE

## PACKAGE DIMENSIONS

ON Semiconductor®



### IPAK CASE 369D-01 ISSUE C

DATE 15 DEC 2010

SCALE 1:1



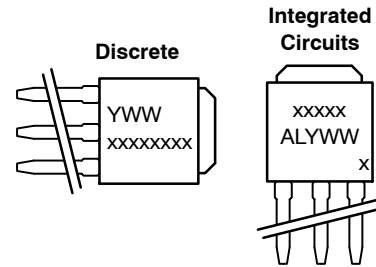
NOTES:

1. DIMENSIONING AND TOLERANCING PER ANSI Y14.5M, 1982.
2. CONTROLLING DIMENSION: INCH.

DIM	INCHES		MILLIMETERS	
	MIN	MAX	MIN	MAX
A	0.235	0.245	5.97	6.35
B	0.250	0.265	6.35	6.73
C	0.086	0.094	2.19	2.38
D	0.027	0.035	0.69	0.88
E	0.018	0.023	0.46	0.58
F	0.037	0.045	0.94	1.14
G	0.090	BSC	2.29	BSC
H	0.034	0.040	0.87	1.01
J	0.018	0.023	0.46	0.58
K	0.350	0.380	8.89	9.65
R	0.180	0.215	4.45	5.45
S	0.025	0.040	0.63	1.01
V	0.035	0.050	0.89	1.27
Z	0.155	---	3.93	---

### MARKING DIAGRAMS

- |  |   |  |  |
|--|---|--|--|
| <p>STYLE 1:<br/>PIN 1. BASE<br/>2. COLLECTOR<br/>3. EMITTER<br/>4. COLLECTOR</p> | <p>STYLE 2:<br/>PIN 1. GATE<br/>2. DRAIN<br/>3. SOURCE<br/>4. DRAIN</p> | <p>STYLE 3:<br/>PIN 1. ANODE<br/>2. CATHODE<br/>3. ANODE<br/>4. CATHODE</p>      | <p>STYLE 4:<br/>PIN 1. CATHODE<br/>2. ANODE<br/>3. GATE<br/>4. ANODE</p> |
| <p>STYLE 5:<br/>PIN 1. GATE<br/>2. ANODE<br/>3. CATHODE<br/>4. ANODE</p>         | <p>STYLE 6:<br/>PIN 1. MT1<br/>2. MT2<br/>3. GATE<br/>4. MT2</p>        | <p>STYLE 7:<br/>PIN 1. GATE<br/>2. COLLECTOR<br/>3. EMITTER<br/>4. COLLECTOR</p> |  |



xxxxxxxx = Device Code  
A = Assembly Location  
IL = Wafer Lot  
Y = Year  
WW = Work Week

<b>DOCUMENT NUMBER:</b>	<b>98AON10528D</b>	Electronic versions are uncontrolled except when accessed directly from the Document Repository. Printed versions are uncontrolled except when stamped "CONTROLLED COPY" in red.
<b>DESCRIPTION:</b>	<b>IPAK (DPAK INSERTION MOUNT)</b>	<b>PAGE 1 OF 1</b>

ON Semiconductor and are trademarks of Semiconductor Components Industries, LLC dba ON Semiconductor or its subsidiaries in the United States and/or other countries. ON Semiconductor reserves the right to make changes without further notice to any products herein. ON Semiconductor makes no warranty, representation or guarantee regarding the suitability of its products for any particular purpose, nor does ON Semiconductor assume any liability arising out of the application or use of any product or circuit, and specifically disclaims any and all liability, including without limitation special, consequential or incidental damages. ON Semiconductor does not convey any license under its patent rights nor the rights of others.

# MECHANICAL CASE OUTLINE PACKAGE DIMENSIONS



## DPAK (SINGLE GAUGE) CASE 369C ISSUE F

DATE 21 JUL 2015

SCALE 1:1



**NOTES:**

1. DIMENSIONING AND TOLERANCING PER ASME Y14.5M, 1994.
2. CONTROLLING DIMENSION: INCHES.
3. THERMAL PAD CONTOUR OPTIONAL WITHIN DIMENSIONS b3, L3 and Z.
4. DIMENSIONS D AND E DO NOT INCLUDE MOLD FLASH, PROTRUSIONS, OR BURRS. MOLD FLASH, PROTRUSIONS, OR GATE BURRS SHALL NOT EXCEED 0.006 INCHES PER SIDE.
5. DIMENSIONS D AND E ARE DETERMINED AT THE OUTERMOST EXTREMES OF THE PLASTIC BODY.
6. DATUMS A AND B ARE DETERMINED AT DATUM PLANE H.
7. OPTIONAL MOLD FEATURE.

DIM	INCHES		MILLIMETERS	
	MIN	MAX	MIN	MAX
A	0.086	0.094	2.18	2.38
A1	0.000	0.005	0.00	0.13
b	0.025	0.035	0.63	0.89
b2	0.028	0.045	0.72	1.14
b3	0.180	0.215	4.57	5.46
c	0.018	0.024	0.46	0.61
c2	0.018	0.024	0.46	0.61
D	0.235	0.245	5.97	6.22
E	0.250	0.265	6.35	6.73
e	0.090	BSC	2.29	BSC
H	0.370	0.410	9.40	10.41
L	0.055	0.070	1.40	1.78
L1	0.114	REF	2.90	REF
L2	0.020	BSC	0.51	BSC
L3	0.035	0.050	0.89	1.27
L4	---	0.040	---	1.01
Z	0.155	---	3.93	---

### GENERIC MARKING DIAGRAM\*

- |   |   |  |  |   |
|---|---|--|--|---|
| <p><b>STYLE 1:</b><br/>PIN 1. BASE<br/>2. COLLECTOR<br/>3. EMITTER<br/>4. COLLECTOR</p> | <p><b>STYLE 2:</b><br/>PIN 1. GATE<br/>2. DRAIN<br/>3. SOURCE<br/>4. DRAIN</p>          | <p><b>STYLE 3:</b><br/>PIN 1. ANODE<br/>2. CATHODE<br/>3. ANODE<br/>4. CATHODE</p> | <p><b>STYLE 4:</b><br/>PIN 1. CATHODE<br/>2. ANODE<br/>3. GATE<br/>4. ANODE</p>              | <p><b>STYLE 5:</b><br/>PIN 1. GATE<br/>2. ANODE<br/>3. CATHODE<br/>4. ANODE</p>     |
| <p><b>STYLE 6:</b><br/>PIN 1. MT1<br/>2. MT2<br/>3. GATE<br/>4. MT2</p>                 | <p><b>STYLE 7:</b><br/>PIN 1. GATE<br/>2. COLLECTOR<br/>3. EMITTER<br/>4. COLLECTOR</p> | <p><b>STYLE 8:</b><br/>PIN 1. N/C<br/>2. CATHODE<br/>3. ANODE<br/>4. CATHODE</p>   | <p><b>STYLE 9:</b><br/>PIN 1. ANODE<br/>2. CATHODE<br/>3. RESISTOR ADJUST<br/>4. CATHODE</p> | <p><b>STYLE 10:</b><br/>PIN 1. CATHODE<br/>2. ANODE<br/>3. CATHODE<br/>4. ANODE</p> |



- XXXXXX = Device Code
- A = Assembly Location
- L = Wafer Lot
- Y = Year
- WW = Work Week
- G = Pb-Free Package

\*This information is generic. Please refer to device data sheet for actual part marking. Pb-Free indicator, "G" or microdot "•", may or may not be present. Some products may not follow the Generic Marking.

### SOLDERING FOOTPRINT\*



\*For additional information on our Pb-Free strategy and soldering details, please download the ON Semiconductor Soldering and Mounting Techniques Reference Manual, SOLDERRM/D.

<b>DOCUMENT NUMBER:</b>	<b>98AON10527D</b>	Electronic versions are uncontrolled except when accessed directly from the Document Repository. Printed versions are uncontrolled except when stamped "CONTROLLED COPY" in red.
<b>DESCRIPTION:</b>	<b>DPAK (SINGLE GAUGE)</b>	<b>PAGE 1 OF 1</b>

onsemi and ONSEMI are trademarks of Semiconductor Components Industries, LLC dba onsemi or its subsidiaries in the United States and/or other countries. onsemi reserves the right to make changes without further notice to any products herein. onsemi makes no warranty, representation or guarantee regarding the suitability of its products for any particular purpose, nor does onsemi assume any liability arising out of the application or use of any product or circuit, and specifically disclaims any and all liability, including without limitation special, consequential or incidental damages. onsemi does not convey any license under its patent rights nor the rights of others.

**onsemi**, **Onsemi**, and other names, marks, and brands are registered and/or common law trademarks of Semiconductor Components Industries, LLC dba "**onsemi**" or its affiliates and/or subsidiaries in the United States and/or other countries. **onsemi** owns the rights to a number of patents, trademarks, copyrights, trade secrets, and other intellectual property. A listing of **onsemi**'s product/patent coverage may be accessed at [www.onsemi.com/site/pdf/Patent-Marking.pdf](http://www.onsemi.com/site/pdf/Patent-Marking.pdf). **onsemi** reserves the right to make changes at any time to any products or information herein, without notice. The information herein is provided "as-is" and **onsemi** makes no warranty, representation or guarantee regarding the accuracy of the information, product features, availability, functionality, or suitability of its products for any particular purpose, nor does **onsemi** assume any liability arising out of the application or use of any product or circuit, and specifically disclaims any and all liability, including without limitation special, consequential or incidental damages. Buyer is responsible for its products and applications using **onsemi** products, including compliance with all laws, regulations and safety requirements or standards, regardless of any support or applications information provided by **onsemi**. "Typical" parameters which may be provided in **onsemi** data sheets and/or specifications can and do vary in different applications and actual performance may vary over time. All operating parameters, including "Typicals" must be validated for each customer application by customer's technical experts. **onsemi** does not convey any license under any of its intellectual property rights nor the rights of others. **onsemi** products are not designed, intended, or authorized for use as a critical component in life support systems or any FDA Class 3 medical devices or medical devices with a same or similar classification in a foreign jurisdiction or any devices intended for implantation in the human body. Should Buyer purchase or use **onsemi** products for any such unintended or unauthorized application, Buyer shall indemnify and hold **onsemi** and its officers, employees, subsidiaries, affiliates, and distributors harmless against all claims, costs, damages, and expenses, and reasonable attorney fees arising out of, directly or indirectly, any claim of personal injury or death associated with such unintended or unauthorized use, even if such claim alleges that **onsemi** was negligent regarding the design or manufacture of the part. **onsemi** is an Equal Opportunity/Affirmative Action Employer. This literature is subject to all applicable copyright laws and is not for resale in any manner.

## PUBLICATION ORDERING INFORMATION

### LITERATURE FULFILLMENT:

Email Requests to: [orderlit@onsemi.com](mailto:orderlit@onsemi.com)

**onsemi Website:** [www.onsemi.com](http://www.onsemi.com)

### TECHNICAL SUPPORT

**North American Technical Support:**

Voice Mail: 1 800-282-9855 Toll Free USA/Canada

Phone: 011 421 33 790 2910

**Europe, Middle East and Africa Technical Support:**

Phone: 00421 33 790 2910

For additional information, please contact your local Sales Representative