

# NTLJS4114N

## MOSFET – Power, Single, N-Channel, $\mu$ Cool, WDFN, 2X2 mm 30 V, 7.8 A

### Features

- WDFN Package Provides Exposed Drain Pad for Excellent Thermal Conduction
- 2x2 mm Footprint Same as SC-88
- Lowest  $R_{DS(on)}$  in 2x2 mm Package
- 1.8 V  $R_{DS(on)}$  Rating for Operation at Low Voltage Logic Level Gate Drive
- Low Profile (< 0.8 mm) for Easy Fit in Thin Environments
- This is a Pb-Free Device

### Applications

- DC-DC Conversion
- Boost Circuits for LED Backlights
- Optimized for Battery and Load Management Applications in Portable Equipment such as, Cell Phones, PDA's, Media Players, etc.
- Low Side Load Switch for Noisy Environment

### MAXIMUM RATINGS ( $T_J = 25^\circ\text{C}$ unless otherwise noted)

Parameter		Symbol	Value	Unit	
Drain-to-Source Voltage		$V_{DSS}$	30	V	
Gate-to-Source Voltage		$V_{GS}$	$\pm 12$	V	
Continuous Drain Current (Note 1)	Steady State	$T_A = 25^\circ\text{C}$	$I_D$	6.0	A
		$T_A = 85^\circ\text{C}$		4.4	
	$t \leq 5$ s	$T_A = 25^\circ\text{C}$		7.8	
Power Dissipation (Note 1)	Steady State	$T_A = 25^\circ\text{C}$	$P_D$	1.92	W
		$t \leq 5$ s		3.3	
Continuous Drain Current (Note 2)	Steady State	$T_A = 25^\circ\text{C}$	$I_D$	3.6	A
		$T_A = 85^\circ\text{C}$		2.6	
		$T_A = 25^\circ\text{C}$	$P_D$	0.70	W
Pulsed Drain Current	$t_p = 10$ $\mu$ s	$I_{DM}$	28	A	
Operating Junction and Storage Temperature		$T_J, T_{STG}$	-55 to 150	$^\circ\text{C}$	
Source Current (Body Diode) (Note 2)		$I_S$	3.0	A	
Lead Temperature for Soldering Purposes (1/8" from case for 10 s)		$T_L$	260	$^\circ\text{C}$	

Stresses exceeding Maximum Ratings may damage the device. Maximum Ratings are stress ratings only. Functional operation above the Recommended Operating Conditions is not implied. Extended exposure to stresses above the Recommended Operating Conditions may affect device reliability.



ON Semiconductor®

<http://onsemi.com>

$V_{(BR)DSS}$	$R_{DS(on)}$ MAX	$I_D$ MAX (Note 1)
30 V	35 m $\Omega$ @ 4.5 V	7.8 A
	45 m $\Omega$ @ 2.5 V	
	55 m $\Omega$ @ 1.8 V	

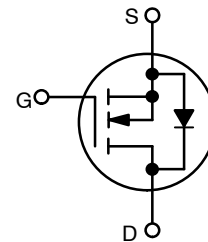

N-CHANNEL MOSFET

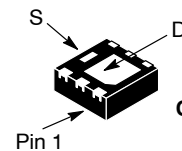

WDFN6  
CASE 506AP  
STYLE 1

### MARKING DIAGRAM

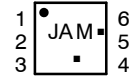

JA = Specific Device Code  
M = Date Code  
▪ = Pb-Free Package  
(Note: Microdot may be in either location)

### PIN CONNECTIONS

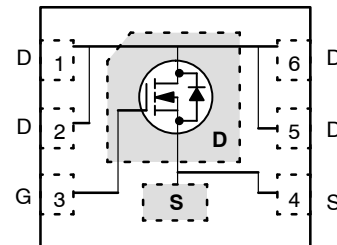

(Top View)

### ORDERING INFORMATION

Device	Package	Shipping†
NTLJS4114NT1G	WDFN6 (Pb-Free)	3000/Tape & Reel
NTLJS4114NTAG	WDFN6 (Pb-Free)	3000/Tape & Reel

†For information on tape and reel specifications, including part orientation and tape sizes, please refer to our Tape and Reel Packaging Specification Brochure, BRD8011/D.

## **NTLJS4114N**

1. Surface Mounted on FR4 Board using 1 in sq pad size (Cu area = 1.127 in sq [2 oz] including traces).
2. Surface Mounted on FR4 Board using the minimum recommended pad size of 30 mm<sup>2</sup>, 2 oz Cu.

# NTLJS4114N

## THERMAL RESISTANCE RATINGS

Parameter	Symbol	Max	Unit
Junction-to-Ambient – Steady State (Note 3)	$R_{\theta JA}$	65	°C/W
Junction-to-Ambient – $t \leq 5$ s (Note 3)	$R_{\theta JA}$	38	
Junction-to-Ambient – Steady State Min Pad (Note 4)	$R_{\theta JA}$	180	

3. Surface Mounted on FR4 Board using 1 in sq pad size (Cu area = 1.127 in sq [2 oz] including traces).  
 4. Surface Mounted on FR4 Board using the minimum recommended pad size (30 mm<sup>2</sup>, 2 oz Cu).

## MOSFET ELECTRICAL CHARACTERISTICS ( $T_J = 25^\circ\text{C}$ unless otherwise noted)

Parameter	Symbol	Test Conditions	Min	Typ	Max	Unit
-----------	--------	-----------------	-----	-----	-----	------

### OFF CHARACTERISTICS

Drain-to-Source Breakdown Voltage	$V_{(BR)DSS}$	$V_{GS} = 0$ V, $I_D = 250$ $\mu$ A	30			V
Drain-to-Source Breakdown Voltage Temperature Coefficient	$V_{(BR)DSS}/T_J$	$I_D = 250$ $\mu$ A, Ref to $25^\circ\text{C}$		20		mV/°C
Zero Gate Voltage Drain Current	$I_{DSS}$	$V_{DS} = 24$ V, $V_{GS} = 0$ V	$T_J = 25^\circ\text{C}$		1.0	$\mu$ A
			$T_J = 85^\circ\text{C}$		10	
Gate-to-Source Leakage Current	$I_{GSS}$	$V_{DS} = 0$ V, $V_{GS} = \pm 12$ V			$\pm 100$	nA

### ON CHARACTERISTICS (Note 5)

Gate Threshold Voltage	$V_{GS(TH)}$	$V_{GS} = V_{DS}$ , $I_D = 250$ $\mu$ A	0.4	0.55	1.0	V
Negative Gate Threshold Temperature Coefficient	$V_{GS(TH)}/T_J$			3.18		mV/°C
Drain-to-Source On-Resistance	$R_{DS(on)}$	$V_{GS} = 4.5$ V, $I_D = 2.0$ A		20.3	35	m $\Omega$
		$V_{GS} = 2.5$ V, $I_D = 2.0$ A		25.8	45	
		$V_{GS} = 1.8$ V, $I_D = 1.8$ A		35.2	55	
Forward Transconductance	$g_{FS}$	$V_{DS} = 16$ V, $I_D = 2.0$ A		8		S

### CHARGES, CAPACITANCES AND GATE RESISTANCE

Input Capacitance	$C_{ISS}$	$V_{GS} = 0$ V, $f = 1.0$ MHz, $V_{DS} = 15$ V		650		pF
Output Capacitance	$C_{OSS}$			115.5		
Reverse Transfer Capacitance	$C_{RSS}$			70		
Total Gate Charge	$Q_{G(TOT)}$	$V_{GS} = 4.5$ V, $V_{DS} = 15$ V, $I_D = 2.0$ A		8.5	13	nC
Threshold Gate Charge	$Q_{G(TH)}$			0.6		
Gate-to-Source Charge	$Q_{GS}$			0.9		
Gate-to-Drain Charge	$Q_{GD}$			2.1		
Gate Resistance	$R_G$			3.0		

### SWITCHING CHARACTERISTICS (Note 6)

Turn-On Delay Time	$t_{d(ON)}$	$V_{GS} = 4.5$ V, $V_{DD} = 15$ V, $I_D = 2.0$ A, $R_G = 3.0$ $\Omega$		5		ns
Rise Time	$t_r$			9		
Turn-Off Delay Time	$t_{d(OFF)}$			20		
Fall Time	$t_f$			4		

### DRAIN-SOURCE DIODE CHARACTERISTICS

Forward Recovery Voltage	$V_{SD}$	$V_{GS} = 0$ V, $I_S = 2.0$ A	$T_J = 25^\circ\text{C}$		0.71	1.2	V
			$T_J = 85^\circ\text{C}$		0.58		
Reverse Recovery Time	$t_{RR}$	$V_{GS} = 0$ V, $d_{ISD}/d_t = 100$ A/ $\mu$ s, $I_S = 1.0$ A			14	35	ns
Charge Time	$t_a$				8.0		
Discharge Time	$t_b$				6.0		
Reverse Recovery Time	$Q_{RR}$				5.0		

5. Pulse Test: Pulse Width  $\leq 300$   $\mu$ s, Duty Cycle  $\leq 2\%$ .  
 6. Switching characteristics are independent of operating junction temperatures.

# NTLJS4114N

## TYPICAL PERFORMANCE CURVES ( $T_J = 25^\circ\text{C}$ unless otherwise noted)

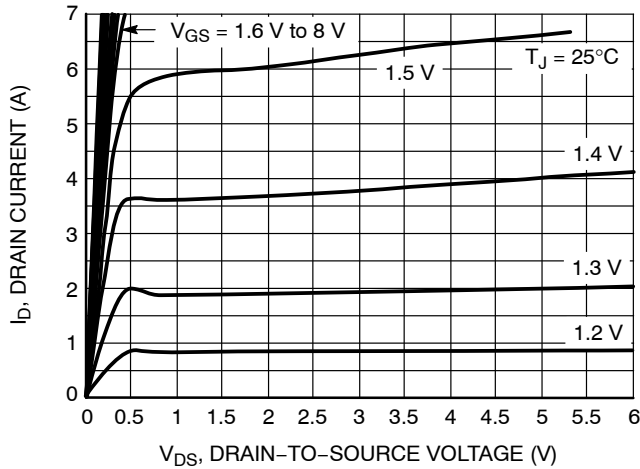

Figure 1. On-Region Characteristics

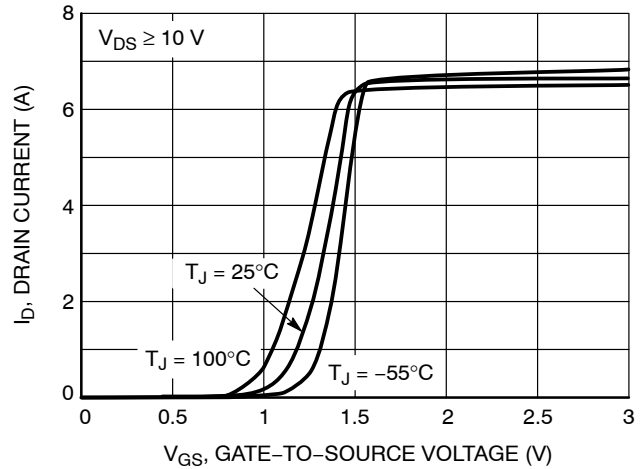

Figure 2. Transfer Characteristics

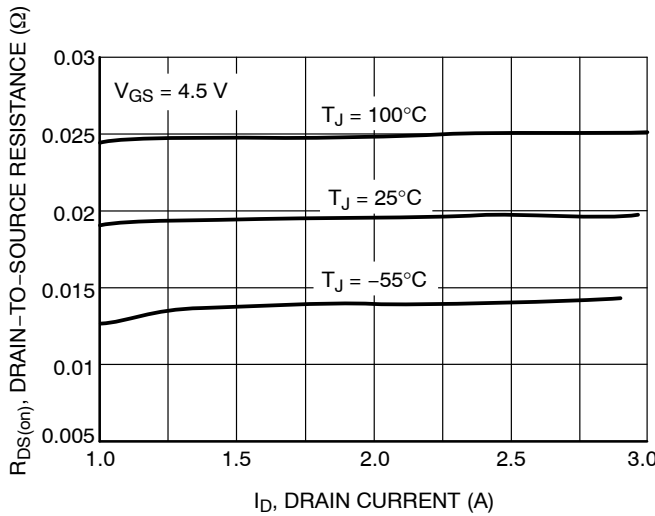

Figure 3. On-Resistance versus Drain Current

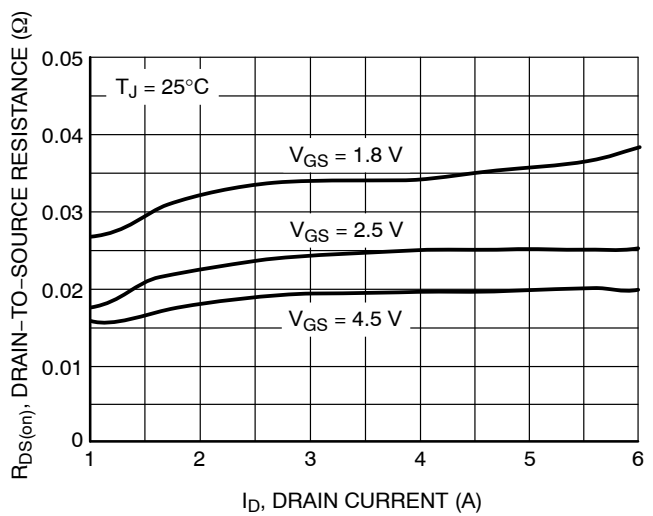

Figure 4. On-Resistance versus Drain Current and Gate Voltage

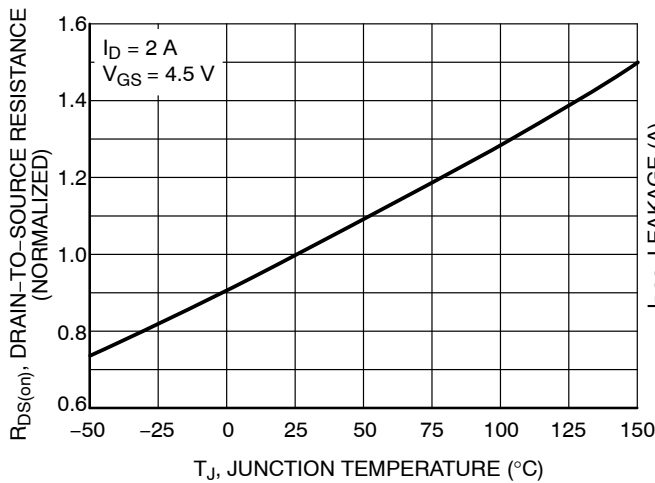

Figure 5. On-Resistance Variation with Temperature

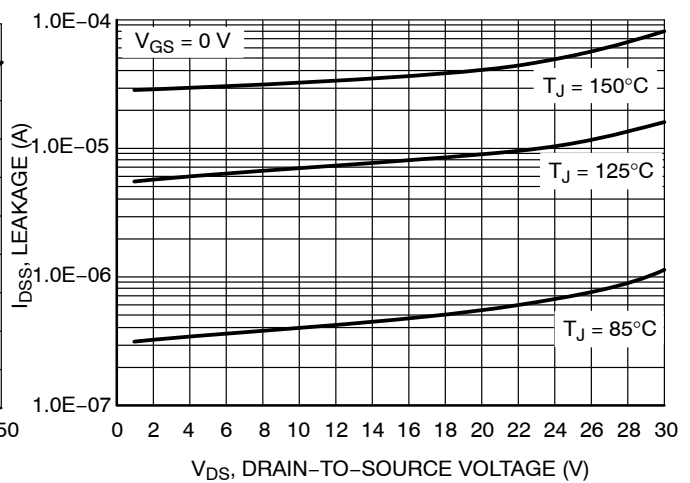

Figure 6. Drain-to-Source Leakage Current versus Voltage

# NTLJS4114N

## TYPICAL PERFORMANCE CURVES ( $T_J = 25^\circ\text{C}$ unless otherwise noted)

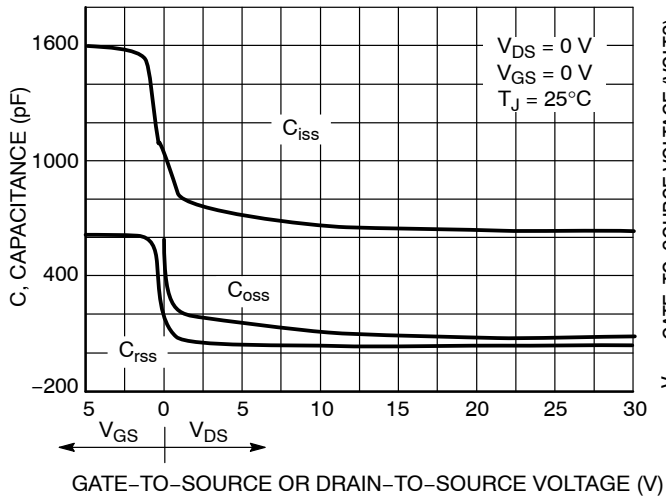

Figure 7. Capacitance Variation

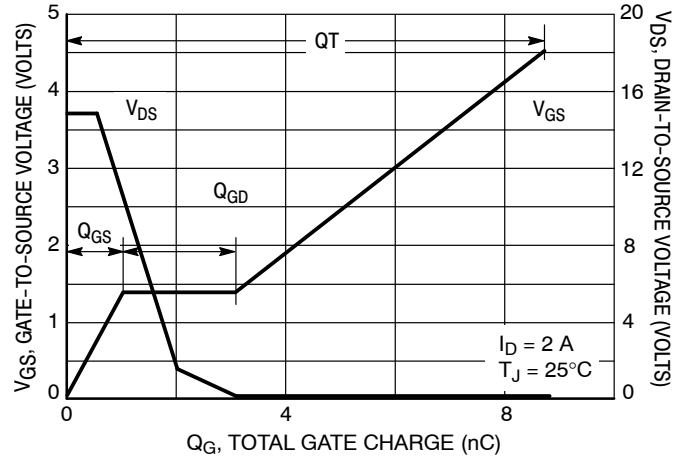

Figure 8. Gate-To-Source and Drain-To-Source Voltage versus Total Charge

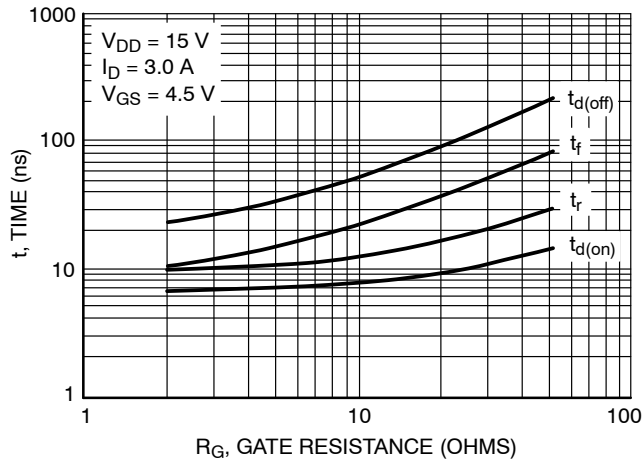

Figure 9. Resistive Switching Time Variation versus Gate Resistance

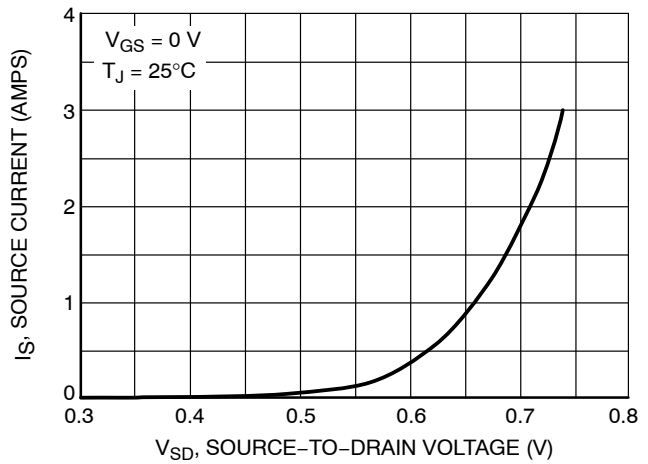

Figure 10. Diode Forward Voltage versus Current

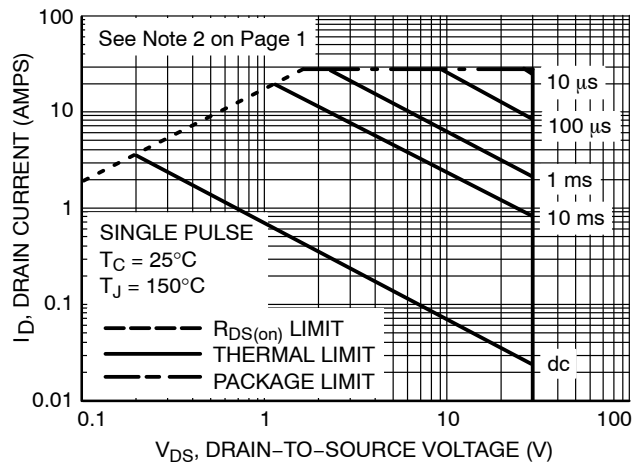

Figure 11. Maximum Rated Forward Biased Safe Operating Area

# NTLJS4114N

## TYPICAL PERFORMANCE CURVES ( $T_J = 25^\circ\text{C}$ unless otherwise noted)

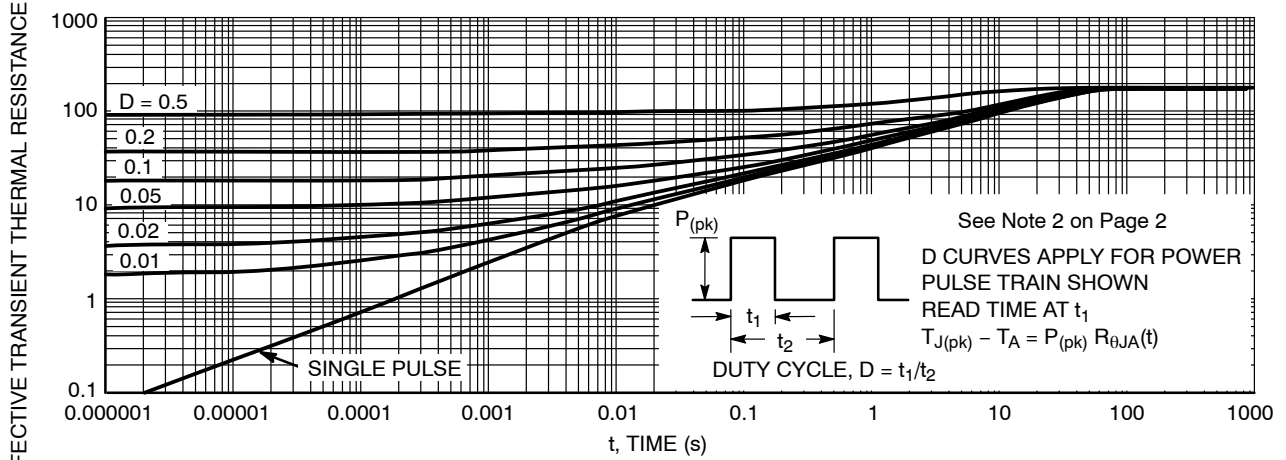

Figure 12. Thermal Response

# MECHANICAL CASE OUTLINE

## PACKAGE DIMENSIONS

ON Semiconductor®



### WDFN6 2x2

#### CASE 506AP-01

#### ISSUE B

DATE 26 APR 2006

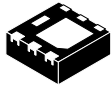

SCALE 4:1

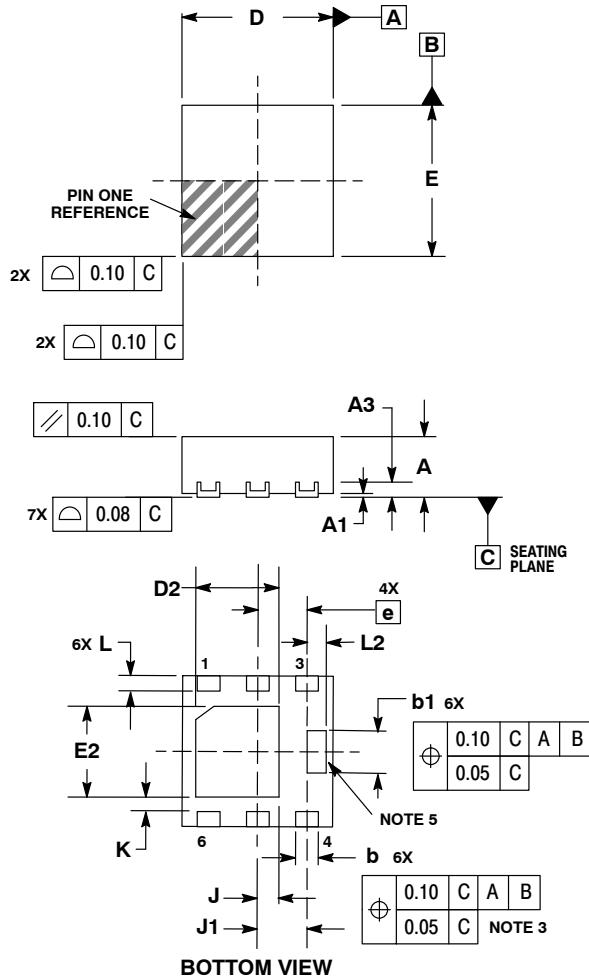

STYLE 1:  
 PIN 1. DRAIN  
 2. DRAIN  
 3. GATE  
 4. SOURCE  
 5. DRAIN  
 6. DRAIN

STYLE 2:  
 PIN 1. COLLECTOR  
 2. COLLECTOR  
 3. BASE  
 4. EMITTER  
 5. COLLECTOR  
 6. COLLECTOR

NOTES:

1. DIMENSIONING AND TOLERANCING PER ASME Y14.5M, 1994.
2. CONTROLLING DIMENSION: MILLIMETERS.
3. DIMENSION b APPLIES TO PLATED TERMINAL AND IS MEASURED BETWEEN 0.15 AND 0.20mm FROM TERMINAL.
4. COPLANARITY APPLIES TO THE EXPOSED PAD AS WELL AS THE TERMINALS.
1. CENTER TERMINAL LEAD IS OPTIONAL. TERMINAL LEAD IS CONNECTED TO TERMINAL LEAD # 4.
2. PINS 1, 2, 5 AND 6 ARE TIED TO THE FLAG.

DIM	MILLIMETERS	
	MIN	MAX
A	0.70	0.80
A1	0.00	0.05
A3	0.20 REF	
b	0.25	0.35
b1	0.51	0.61
D	2.00 BSC	
D2	1.00	1.20
E	2.00 BSC	
E2	1.10	1.30
e	0.65 BSC	
K	0.15 REF	
L	0.20	0.30
L2	0.20	0.30
J	0.27 REF	
J1	0.65 REF	

### GENERIC MARKING DIAGRAM\*

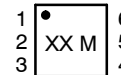

XX = Specific Device Code  
 M = Date Code

\*This information is generic. Please refer to device data sheet for actual part marking. Pb-Free indicator, "G" or microdot "•", may or may not be present.

### SOLDERMASK DEFINED MOUNTING FOOTPRINT

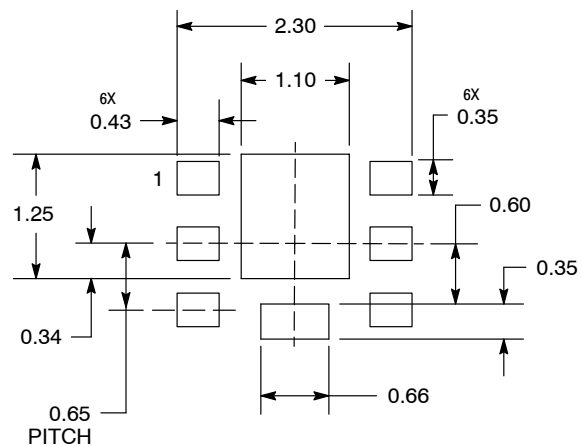

DIMENSIONS: MILLIMETERS

<b>DOCUMENT NUMBER:</b>	<b>98AON20860D</b>	Electronic versions are uncontrolled except when accessed directly from the Document Repository. Printed versions are uncontrolled except when stamped "CONTROLLED COPY" in red.
<b>DESCRIPTION:</b>	<b>6 PIN WDFN 2X2, 0.65P</b>	<b>PAGE 1 OF 1</b>

ON Semiconductor and ON are trademarks of Semiconductor Components Industries, LLC dba ON Semiconductor or its subsidiaries in the United States and/or other countries. ON Semiconductor reserves the right to make changes without further notice to any products herein. ON Semiconductor makes no warranty, representation or guarantee regarding the suitability of its products for any particular purpose, nor does ON Semiconductor assume any liability arising out of the application or use of any product or circuit, and specifically disclaims any and all liability, including without limitation special, consequential or incidental damages. ON Semiconductor does not convey any license under its patent rights nor the rights of others.

**onsemi**, **Onsemi**, and other names, marks, and brands are registered and/or common law trademarks of Semiconductor Components Industries, LLC dba "**onsemi**" or its affiliates and/or subsidiaries in the United States and/or other countries. **onsemi** owns the rights to a number of patents, trademarks, copyrights, trade secrets, and other intellectual property. A listing of **onsemi**'s product/patent coverage may be accessed at [www.onsemi.com/site/pdf/Patent-Marking.pdf](http://www.onsemi.com/site/pdf/Patent-Marking.pdf). **onsemi** reserves the right to make changes at any time to any products or information herein, without notice. The information herein is provided "as-is" and **onsemi** makes no warranty, representation or guarantee regarding the accuracy of the information, product features, availability, functionality, or suitability of its products for any particular purpose, nor does **onsemi** assume any liability arising out of the application or use of any product or circuit, and specifically disclaims any and all liability, including without limitation special, consequential or incidental damages. Buyer is responsible for its products and applications using **onsemi** products, including compliance with all laws, regulations and safety requirements or standards, regardless of any support or applications information provided by **onsemi**. "Typical" parameters which may be provided in **onsemi** data sheets and/or specifications can and do vary in different applications and actual performance may vary over time. All operating parameters, including "Typicals" must be validated for each customer application by customer's technical experts. **onsemi** does not convey any license under any of its intellectual property rights nor the rights of others. **onsemi** products are not designed, intended, or authorized for use as a critical component in life support systems or any FDA Class 3 medical devices or medical devices with a same or similar classification in a foreign jurisdiction or any devices intended for implantation in the human body. Should Buyer purchase or use **onsemi** products for any such unintended or unauthorized application, Buyer shall indemnify and hold **onsemi** and its officers, employees, subsidiaries, affiliates, and distributors harmless against all claims, costs, damages, and expenses, and reasonable attorney fees arising out of, directly or indirectly, any claim of personal injury or death associated with such unintended or unauthorized use, even if such claim alleges that **onsemi** was negligent regarding the design or manufacture of the part. **onsemi** is an Equal Opportunity/Affirmative Action Employer. This literature is subject to all applicable copyright laws and is not for resale in any manner.

## PUBLICATION ORDERING INFORMATION

### LITERATURE FULFILLMENT:

Email Requests to: [orderlit@onsemi.com](mailto:orderlit@onsemi.com)

**onsemi Website:** [www.onsemi.com](http://www.onsemi.com)

### TECHNICAL SUPPORT

**North American Technical Support:**

Voice Mail: 1 800-282-9855 Toll Free USA/Canada

Phone: 011 421 33 790 2910

**Europe, Middle East and Africa Technical Support:**

Phone: 00421 33 790 2910

For additional information, please contact your local Sales Representative