



Is Now Part of



ON Semiconductor®

To learn more about ON Semiconductor, please visit our website at
www.onsemi.com

Please note: As part of the Fairchild Semiconductor integration, some of the Fairchild orderable part numbers will need to change in order to meet ON Semiconductor's system requirements. Since the ON Semiconductor product management systems do not have the ability to manage part nomenclature that utilizes an underscore (_), the underscore (_) in the Fairchild part numbers will be changed to a dash (-). This document may contain device numbers with an underscore (_). Please check the ON Semiconductor website to verify the updated device numbers. The most current and up-to-date ordering information can be found at www.onsemi.com. Please email any questions regarding the system integration to Fairchild_questions@onsemi.com.

ON Semiconductor and the ON Semiconductor logo are trademarks of Semiconductor Components Industries, LLC dba ON Semiconductor or its subsidiaries in the United States and/or other countries. ON Semiconductor owns the rights to a number of patents, trademarks, copyrights, trade secrets, and other intellectual property. A listing of ON Semiconductor's product/patent coverage may be accessed at www.onsemi.com/site/pdf/Patent-Marking.pdf. ON Semiconductor reserves the right to make changes without further notice to any products herein. ON Semiconductor makes no warranty, representation or guarantee regarding the suitability of its products for any particular purpose, nor does ON Semiconductor assume any liability arising out of the application or use of any product or circuit, and specifically disclaims any and all liability, including without limitation special, consequential or incidental damages. Buyer is responsible for its products and applications using ON Semiconductor products, including compliance with all laws, regulations and safety requirements or standards, regardless of any support or applications information provided by ON Semiconductor. "Typical" parameters which may be provided in ON Semiconductor data sheets and/or specifications can and do vary in different applications and actual performance may vary over time. All operating parameters, including "Typicals" must be validated for each customer application by customer's technical experts. ON Semiconductor does not convey any license under its patent rights nor the rights of others. ON Semiconductor products are not designed, intended, or authorized for use as a critical component in life support systems or any FDA Class 3 medical devices or medical devices with a same or similar classification in a foreign jurisdiction or any devices intended for implantation in the human body. Should Buyer purchase or use ON Semiconductor products for any such unintended or unauthorized application, Buyer shall indemnify and hold ON Semiconductor and its officers, employees, subsidiaries, affiliates, and distributors harmless against all claims, costs, damages, and expenses, and reasonable attorney fees arising out of, directly or indirectly, any claim of personal injury or death associated with such unintended or unauthorized use, even if such claim alleges that ON Semiconductor was negligent regarding the design or manufacture of the part. ON Semiconductor is an Equal Opportunity/Affirmative Action Employer. This literature is subject to all applicable copyright laws and is not for resale in any manner.

FCP380N60E / FCPF380N60E

N 沟道 SuperFET® II Easy-Drive MOSFET

600 V, 10.2 A, 380 mΩ

特性

- 650 V @ $T_J = 150^\circ\text{C}$
- 典型值 $R_{DS(on)} = 320\text{ m}\Omega$
- 超低栅极电荷 (典型值 $Q_g = 34\text{ nC}$)
- 低有效输出电容 (典型值 $C_{oss(eff.)} = 97\text{ pF}$)
- 100% 经过雪崩测试
- 集成栅极电阻
- 符合 RoHS 标准

应用

- LCD / LED / PDP 电视照明
- 太阳能逆变器
- AC-DC 电源

说明

SuperFET® II MOSFET 是飞兆半导体新一代利用电荷平衡技术实现出色低导通电阻和更低栅极电荷性能的高压超级结 (SJ) MOSFET 系列产品。这项技术专用于最小化导通损耗并提供卓越的开关性能、dv/dt 额定值和更高雪崩能量。类似地, 与 SuperFET II MOSFET 系列相比, SuperFET II MOSFET Easy-Drive 系列具有略有缓慢的上升和下降时间。该系列产品型号以“E”作为前缀, 有助于解决 EMI 问题, 设计部署更为简单。如需获得更快的开关速度并用于开关损耗必须尽可能低的应用中, 请考虑使用 SuperFET II MOSFET 系列。

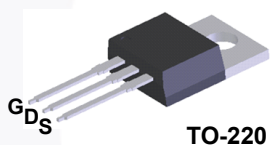

TO-220

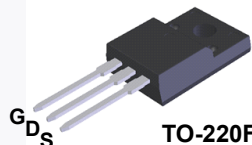

TO-220F

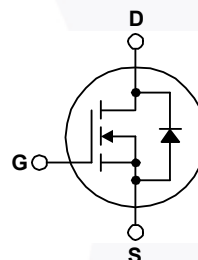

绝对最大额定值 $T_C = 25^\circ\text{C}$ 除非另有说明。

符号	参数	FCP380N60E	FCPF380N60E	单位
V_{DSS}	漏极-源极电压	600		V
V_{GSS}	栅极-源极电压	- DC	± 20	V
		- AC (f > 1 Hz)	± 30	
I_D	漏极电流	- 连续 ($T_C = 25^\circ\text{C}$)	10.2	10.2*
		- 连续 ($T_C = 100^\circ\text{C}$)	6.4	6.4*
I_{DM}	漏极电流	- 脉冲 (说明 1)	30.6	30.6*
E_{AS}	单脉冲雪崩能量 (说明 2)	211.6		mJ
I_{AR}	雪崩电流 (说明 1)	2.3		A
E_{AR}	重复雪崩能量 (说明 1)	1.06		mJ
dv/dt	MOSFET dv/dt	100		V/ns
	二极管恢复 dv/dt 峰值 (说明 3)	20		
P_D	功耗	($T_C = 25^\circ\text{C}$)	106	31
		- 降低至 25°C 以上	0.85	0.25
T_J, T_{STG}	工作和存储温度范围	-55 至 +150		$^\circ\text{C}$
T_L	用于焊接的最大引线温度, 距离外壳 1/8", 持续 5 秒	300		$^\circ\text{C}$

* 漏极电流受限于最大结温

热性能

符号	参数	FCP380N60E	FCPF380N60E	单位
$R_{\theta JC}$	结至外壳热阻最大值	1.18	4	$^\circ\text{C}/\text{W}$
$R_{\theta JA}$	结至环境热阻最大值	62.5	62.5	

封装标识与订购信息

器件编号	顶标	封装	包装方法	卷尺寸	带宽	数量
FCP380N60E	FCP380N60E	TO-220	塑料管	不适用	不适用	50 个
FCPF380N60E	FCPF380N60E	TO-220F	塑料管	不适用	不适用	50 个

电气特性, $T_C = 25^\circ\text{C}$ 除非另有说明。

符号	参数	测试条件	最小值	典型值	最大值	单位
----	----	------	-----	-----	-----	----

关断特性

BV_{DSS}	漏极 - 源极击穿电压	$V_{GS} = 0\text{ V}, I_D = 10\text{ mA}, T_J = 25^\circ\text{C}$	600	-	-	V
		$V_{GS} = 0\text{ V}, I_D = 10\text{ mA}, T_J = 150^\circ\text{C}$	650	-	-	
$\Delta BV_{DSS} / \Delta T_J$	击穿电压温度系数	$I_D = 10\text{ mA}$, 参考条件为 25°C	-	0.67	-	$\text{V}/^\circ\text{C}$
BV_{DS}	漏极 - 源极雪崩击穿电压	$V_{GS} = 0\text{ V}, I_D = 10\text{ A}$	-	700	-	V
I_{DSS}	零栅极电压漏极电流	$V_{DS} = 480\text{ V}, V_{GS} = 0\text{ V}$	-	-	1	μA
		$V_{DS} = 480\text{ V}, T_C = 125^\circ\text{C}$	-	-	10	
I_{GSS}	栅极 - 体漏电流	$V_{GS} = \pm 20\text{ V}, V_{DS} = 0\text{ V}$	-	-	± 100	nA

导通特性

$V_{GS(th)}$	栅极阈值电压	$V_{GS} = V_{DS}, I_D = 250\ \mu\text{A}$	2.5	-	3.5	V
$R_{DS(on)}$	漏极至源极静态导通电阻	$V_{GS} = 10\text{ V}, I_D = 5\text{ A}$	-	0.32	0.38	Ω
g_{FS}	正向跨导	$V_{DS} = 20\text{ V}, I_D = 5\text{ A}$	-	10	-	S

动态特性

C_{iss}	输入电容	$V_{DS} = 25\text{ V}, V_{GS} = 0\text{ V}, f = 1\text{ MHz}$	-	1330	1770	pF
C_{oss}	输出电容		-	945	1260	pF
C_{riss}	反向传输电容		-	60	90	pF
C_{oss}	输出电容	$V_{DS} = 380\text{ V}, V_{GS} = 0\text{ V}, f = 1\text{ MHz}$	-	25	-	pF
$C_{oss(eff.)}$	有效输出电容	$V_{DS} = 0\text{ V}$ 至 $480\text{ V}, V_{GS} = 0\text{ V}$	-	97	-	pF
$Q_{g(tot)}$	10 V 的栅极电荷总量	$V_{DS} = 380\text{ V}, I_D = 5\text{ A}, V_{GS} = 10\text{ V}$ (说明 4)	-	34	45	nC
Q_{gs}	栅极 - 源极栅极电荷		-	5.3	-	nC
Q_{gd}	栅极 - 漏极“米勒”电荷		-	13	-	nC
ESR	等效串联电阻	$f = 1\text{ MHz}$	-	6	-	Ω

开关特性

$t_{d(on)}$	导通延迟时间	$V_{DD} = 380\text{ V}, I_D = 5\text{ A}, V_{GS} = 10\text{ V}, R = 4.7\ \Omega$ (说明 4)	-	17	44	ns
t_r	开通上升时间		-	9	28	ns
$t_{d(off)}$	关断延迟时间		-	64	138	ns
t_f	关断下降时间		-	10	30	ns

漏极 - 源极二极管特性

I_S	漏极 - 源极二极管最大正向连续电流	-	-	10.2	A	
I_{SM}	漏极 - 源极二极管最大正向脉冲电流	-	-	30.6	A	
V_{SD}	漏极 - 源极二极管正向电压	$V_{GS} = 0\text{ V}, I_{SD} = 5\text{ A}$	-	-	1.2	V
t_{rr}	反向恢复时间	$V_{GS} = 0\text{ V}, I_{SD} = 5\text{ A}, di_F/dt = 100\text{ A}/\mu\text{s}$	-	240	-	ns
Q_{rr}	反向恢复电荷		-	3	-	μC

注意:

- 重复额定值: 脉冲宽度受限于最大结温。
- $I_{AS} = 2.3\text{ A}$, $V_{DD} = 50\text{ V}$, $R_G = 25\ \Omega$, 启动 $T_J = 25^\circ\text{C}$ 。
- $I_{SD} \leq 5.1\text{ A}$, $di/dt \leq 200\text{ A}/\mu\text{s}$, $V_{DD} \leq BV_{DSS}$, 启动 $T_J = 25^\circ\text{C}$ 。
- 本质上独立于工作温度的典型特性。

典型性能特征

图 1. 通态区域特性



图 2. 传递特性



图 3. 导通电阻变化与漏极电流和栅极电压

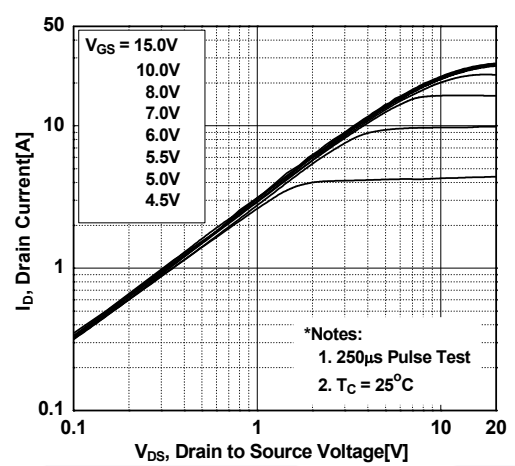

图 4. 体二极管正向电压变化与源极电流和温度

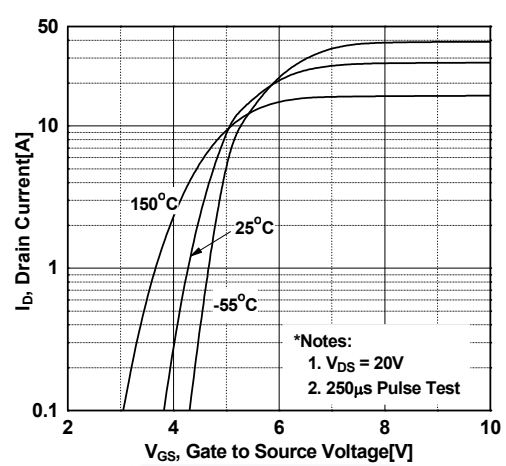

图 5. 电容特性

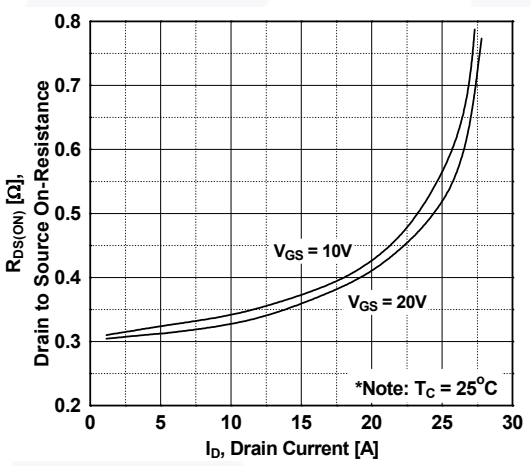

图 6. 栅极电荷特性

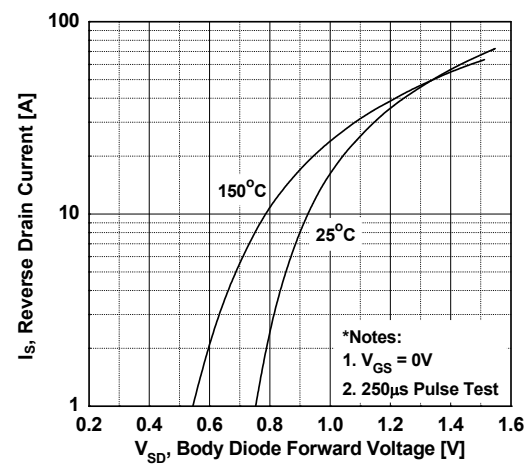

典型性能特征 (接上页)

图 7. 击穿电压变化与温度

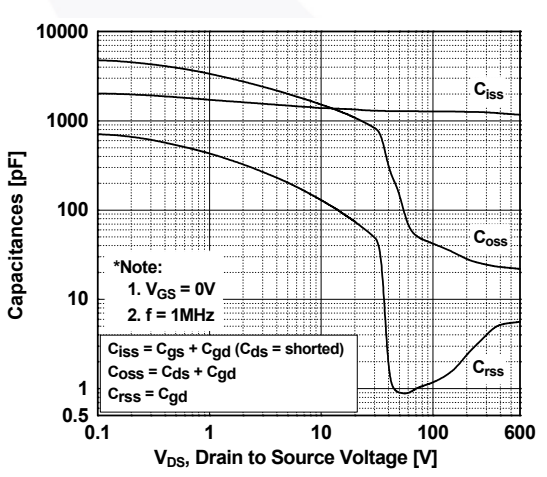
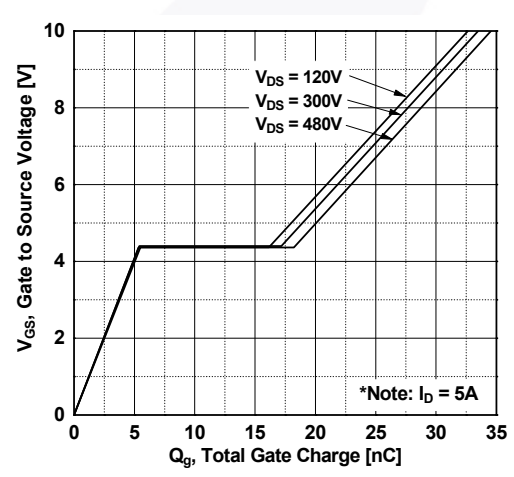

图 8. 导通电阻变化与温度



图 9. 最大安全工作区 (FCP380N60E)

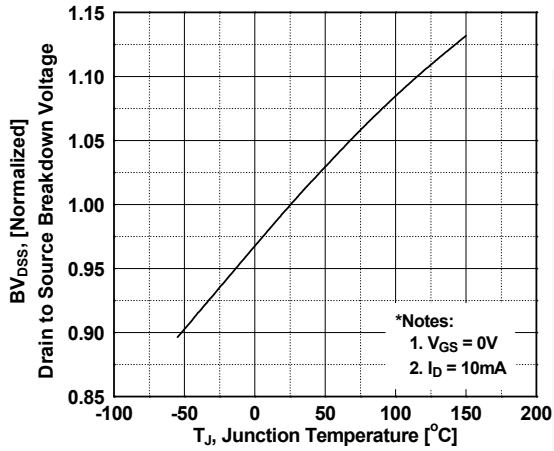

图 10. 最大安全操作区 (FCPF380N60E)

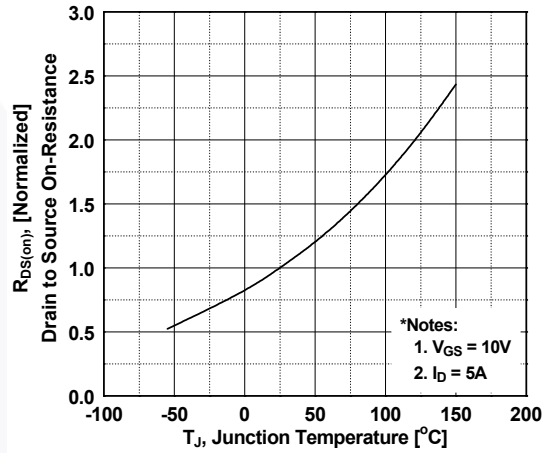

图 11. 最大漏极电流与壳体温度的关系

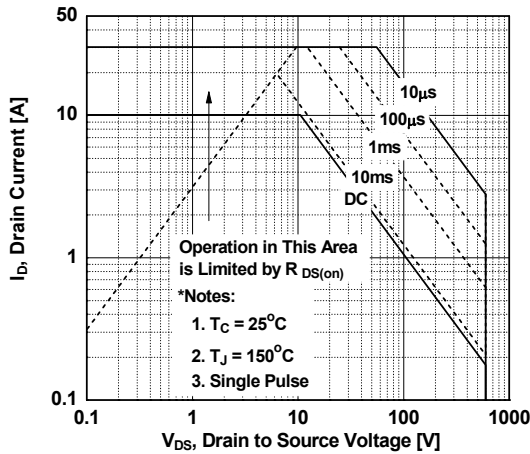

图 12. E_oss 与漏极-源极电压的关系

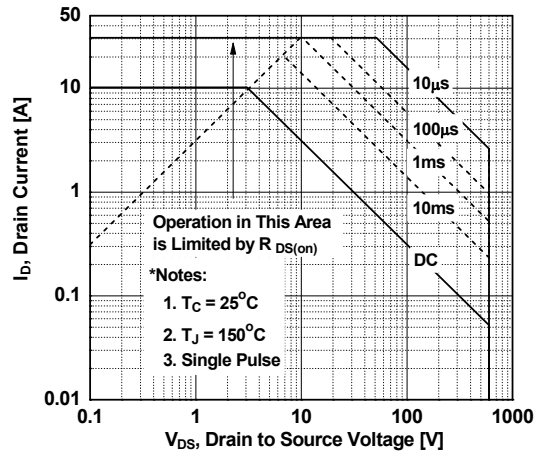

典型性能特征 (接上页)

图 13. 瞬态热响应曲线 (FCP380N60E)

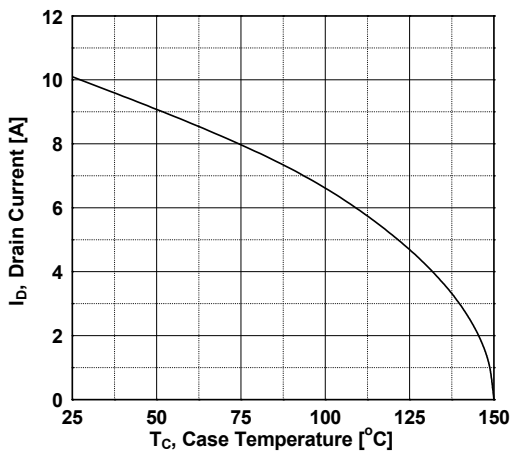
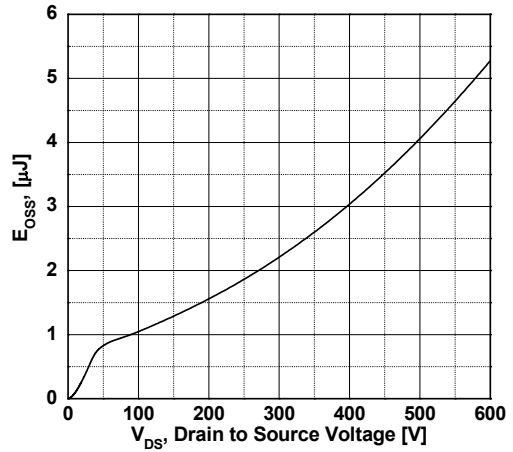

图 14. 瞬态热响应曲线 (FCPF380N60E)





图 15. 栅极电荷测试电路与波形

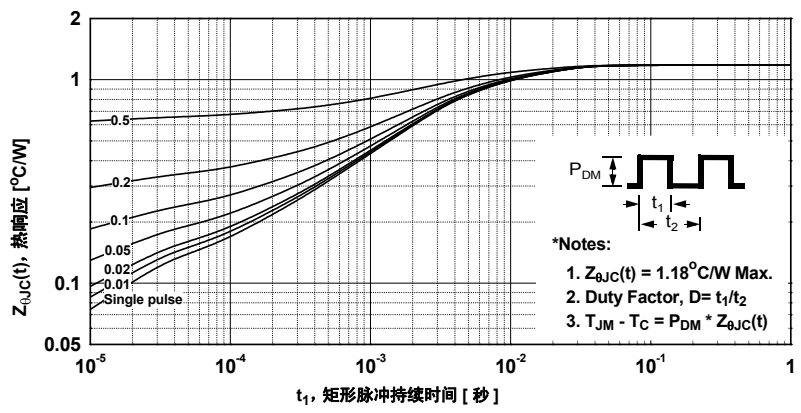
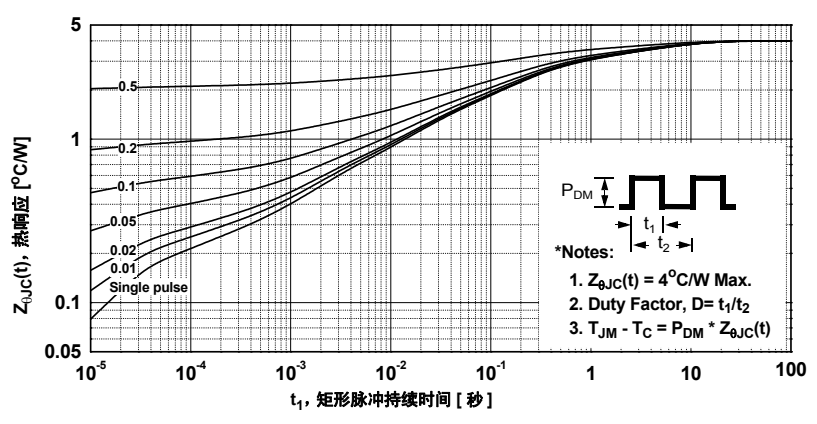

图 16. 阻性开关测试电路与波形

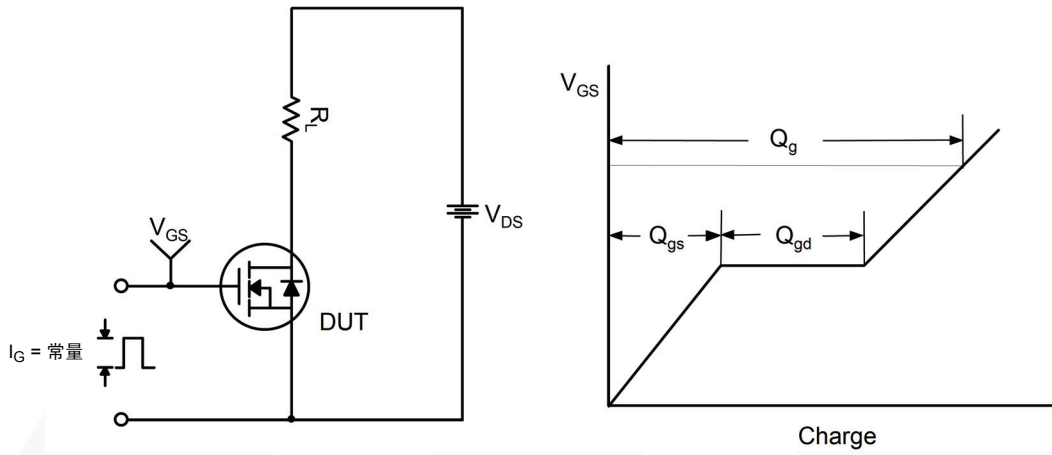

图 17. 非箝位感性开关测试电路与波形



图 18. 二极管恢复 dv/dt 峰值测试电路与波形

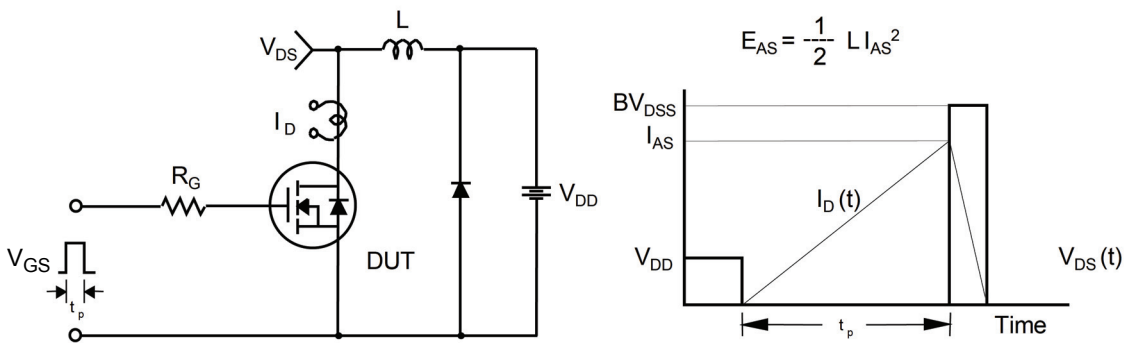

- NOTES:
- A) REFERENCE JEDEC, TO-220, VARIATION AB
 - B) ALL DIMENSIONS ARE IN MILLIMETERS.
 - C) DIMENSIONS COMMON TO ALL PACKAGE SUPPLIERS EXCEPT WHERE NOTED [].
 - D) LOCATION OF MOLDED FEATURE MAY VARY (LOWER LEFT CORNER, LOWER CENTER AND CENTER OF THE PACKAGE)
 - E) DOES NOT COMPLY JEDEC STANDARD VALUE.
 - F) "A1" DIMENSIONS AS BELOW:
 SINGLE GAUGE = 0.51 - 0.61
 DUAL GAUGE = 1.10 - 1.45
 - G) DRAWING FILE NAME: TO220B03REV9
 - H) PRESENCE IS SUPPLIER DEPENDENT
 - I) SUPPLIER DEPENDENT MOLD LOCKING HOLES IN HEATSINK.



ON Semiconductor



NOTES:

- A. EXCEPT WHERE NOTED CONFORMS TO EIAJ SC91A.
- B. DOES NOT COMPLY EIAJ STD. VALUE.
- C. ALL DIMENSIONS ARE IN MILLIMETERS.
- D. DIMENSIONS ARE EXCLUSIVE OF BURRS, MOLD FLASH AND TIE BAR PROTRUSIONS.
- E. DIMENSION AND TOLERANCE AS PER ASME Y14.5-1994.
- F. OPTION 1 - WITH SUPPORT PIN HOLE.
OPTION 2 - NO SUPPORT PIN HOLE.
- G. DRAWING FILE NAME: TO220M03REV5

ON Semiconductor and  are trademarks of Semiconductor Components Industries, LLC dba ON Semiconductor or its subsidiaries in the United States and/or other countries. ON Semiconductor owns the rights to a number of patents, trademarks, copyrights, trade secrets, and other intellectual property. A listing of ON Semiconductor's product/patent coverage may be accessed at www.onsemi.com/site/pdf/Patent-Marking.pdf. ON Semiconductor reserves the right to make changes without further notice to any products herein. ON Semiconductor makes no warranty, representation or guarantee regarding the suitability of its products for any particular purpose, nor does ON Semiconductor assume any liability arising out of the application or use of any product or circuit, and specifically disclaims any and all liability, including without limitation special, consequential or incidental damages. Buyer is responsible for its products and applications using ON Semiconductor products, including compliance with all laws, regulations and safety requirements or standards, regardless of any support or applications information provided by ON Semiconductor. "Typical" parameters which may be provided in ON Semiconductor data sheets and/or specifications can and do vary in different applications and actual performance may vary over time. All operating parameters, including "Typicals" must be validated for each customer application by customer's technical experts. ON Semiconductor does not convey any license under its patent rights nor the rights of others. ON Semiconductor products are not designed, intended, or authorized for use as a critical component in life support systems or any FDA Class 3 medical devices or medical devices with a same or similar classification in a foreign jurisdiction or any devices intended for implantation in the human body. Should Buyer purchase or use ON Semiconductor products for any such unintended or unauthorized application, Buyer shall indemnify and hold ON Semiconductor and its officers, employees, subsidiaries, affiliates, and distributors harmless against all claims, costs, damages, and expenses, and reasonable attorney fees arising out of, directly or indirectly, any claim of personal injury or death associated with such unintended or unauthorized use, even if such claim alleges that ON Semiconductor was negligent regarding the design or manufacture of the part. ON Semiconductor is an Equal Opportunity/Affirmative Action Employer. This literature is subject to all applicable copyright laws and is not for resale in any manner.

PUBLICATION ORDERING INFORMATION

LITERATURE FULFILLMENT:

Literature Distribution Center for ON Semiconductor
19521 E. 32nd Pkwy, Aurora, Colorado 80011 USA
Phone: 303-675-2175 or 800-344-3860 Toll Free USA/Canada
Fax: 303-675-2176 or 800-344-3867 Toll Free USA/Canada
Email: orderlit@onsemi.com

N. American Technical Support: 800-282-9855 Toll Free
USA/Canada
Europe, Middle East and Africa Technical Support:
Phone: 421 33 790 2910
Japan Customer Focus Center
Phone: 81-3-5817-1050

ON Semiconductor Website: www.onsemi.com
Order Literature: <http://www.onsemi.com/orderlit>
For additional information, please contact your local
Sales Representative