



Standard Recovery Diodes, (Hockey PUK Version), 1170 A



B-PUK (DO-200AB)

FEATURES

- Wide current range
- High voltage ratings up to 3200 V
- High surge current capabilities
- Diffused junction
- Hockey PUK version
- Case style B-PUK (DO-200AB)
- Designed and qualified for industrial level
- Material categorization: for definitions of compliance please see www.vishay.com/doc?99912



RoHS
COMPLIANT

TYPICAL APPLICATIONS

- Converters
- Power supplies
- Machine tool controls
- High power drives
- Medium traction applications

PRIMARY CHARACTERISTICS	
$I_{F(AV)}$	1170 A
Package	B-PUK (DO-200AB)
Circuit configuration	Single

MAJOR RATINGS AND CHARACTERISTICS				
PARAMETER	TEST CONDITIONS	VS-SD1100C..L		UNITS
		04 to 20	25 to 32	
$I_{F(AV)}$		1170	910	A
	T_{hs}	55	55	°C
$I_{F(RMS)}$		2080	1660	A
	T_{hs}	25	25	°C
I_{FSM}	50 Hz	13 000	10 500	A
	60 Hz	13 600	11 000	
I^2t	50 Hz	846	551	kA ² s
	60 Hz	772	503	
V_{RRM}	Range	400 to 2000	2500 to 3200	V
T_J		-40 to +180	-40 to +150	°C

ELECTRICAL SPECIFICATIONS

VOLTAGE RATINGS				
TYPE NUMBER	VOLTAGE CODE	V_{RRM} , MAXIMUM REPETITIVE PEAK REVERSE VOLTAGE V	V_{RSM} , MAXIMUM NON-REPETITIVE PEAK REVERSE VOLTAGE V	I_{RRM} MAXIMUM AT $T_J = T_J$ MAXIMUM mA
VS-SD1100C..L	04	400	500	15
	08	800	900	
	12	1200	1300	
	16	1600	1700	
	20	2000	2100	
	25	2500	2600	
	30	3000	3100	
	32	3200	3300	



FORWARD CONDUCTION						
PARAMETER	SYMBOL	TEST CONDITIONS		VS-SD1100C..L		UNITS
				04 to 20	25 to 32	
Maximum average forward current at heatsink temperature	$I_{F(AV)}$	180° conduction, half sine wave Double side (single side) cooled		1170 (600)	910 (420)	A
				55 (85)	55 (85)	°C
Maximum RMS forward current	$I_{F(RMS)}$	25 °C heatsink temperature double side cooled		2080	1660	A
Maximum peak, one-cycle forward, non-repetitive surge current	I_{FSM}	t = 10 ms	No voltage reappplied	13 000	10 500	
		t = 8.3 ms		13 600	11 000	
		t = 10 ms	100 % V_{RRM} reappplied	10 930	8830	
		t = 8.3 ms		11 450	9250	
Maximum I^2t for fusing	I^2t	t = 10 ms	No voltage reappplied	846	551	kA ² s
		t = 8.3 ms		772	503	
		t = 10 ms	100 % V_{RRM} reappplied	598	390	
		t = 8.3 ms		546	356	
Maximum $I^2\sqrt{t}$ for fusing	$I^2\sqrt{t}$	t = 0.1 to 10 ms, no voltage reappplied		8460	5510	kA ² √s
Low level value of threshold voltage	$V_{F(TO)1}$	(16.7 % $\times \pi \times I_{F(AV)} < I < \pi \times I_{F(AV)}$), $T_J = T_J$ maximum		0.78	0.84	V
High level value of threshold voltage	$V_{F(TO)2}$	(I > $\pi \times I_{F(AV)}$), $T_J = T_J$ maximum		0.94	0.88	
Low level value of forward slope resistance	r_{f1}	(16.7 % $\times \pi \times I_{F(AV)} < I < \pi \times I_{F(AV)}$), $T_J = T_J$ maximum		0.35	0.40	mW
High level value of forward slope resistance	r_{f2}	(I > $\pi \times I_{F(AV)}$), $T_J = T_J$ maximum		0.26	0.38	
Maximum forward voltage drop	V_{FM}	$I_{pk} = 1500$ A, $T_J = T_J$ maximum, $t_p = 10$ ms sinusoidal wave		1.31	1.44	V

THERMAL AND MECHANICAL SPECIFICATIONS						
PARAMETER	SYMBOL	TEST CONDITIONS		SD1100C..L		UNITS
				04 to 20	25 to 32	
Maximum junction operating temperature range	T_J			-40 to +180	-40 to +150	°C
Maximum storage temperature range	T_{Stg}			-55 to +200		
Maximum thermal resistance, junction to heatsink	R_{thJ-hs}	DC operation single side cooled		0.11		K/W
		DC operation double side cooled		0.05		
Mounting force, ± 10 %				9800 (1000)		N (kg)
Approximate weight				250		g
Case style		See dimensions - link at the end of datasheet		B-PUK (DO-200AB)		

ΔR_{thJ-hs} CONDUCTION						
CONDUCTION ANGLE	SINUSOIDAL CONDUCTION		RECTANGULAR CONDUCTION		TEST CONDITIONS	UNITS
	SINGLE SIDE	DOUBLE SIDE	SINGLE SIDE	DOUBLE SIDE		
180°	0.011	0.011	0.008	0.008	$T_J = T_J$ maximum	K/W
120°	0.014	0.015	0.014	0.014		
90°	0.018	0.018	0.019	0.019		
60°	0.026	0.026	0.027	0.028		
30°	0.045	0.046	0.046	0.046		

Note

- The table above shows the increment of thermal resistance R_{thJ-hs} when devices operate at different conduction angles than DC

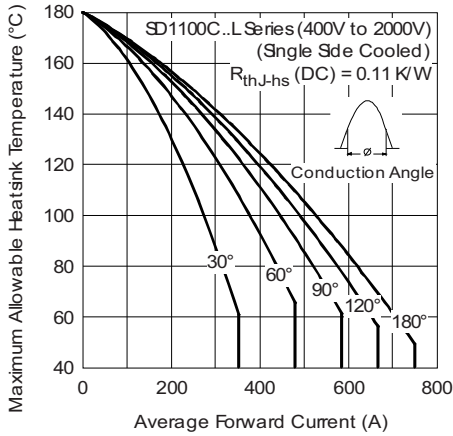

Fig. 1 - Current Ratings Characteristics

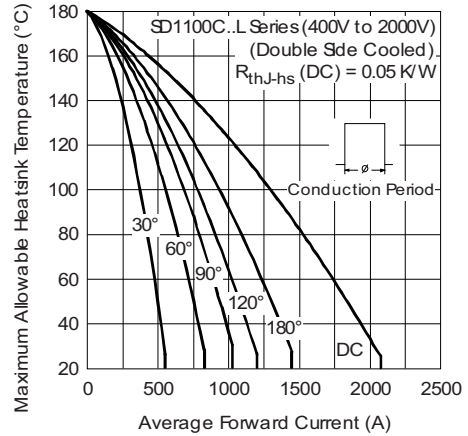

Fig. 4 - Current Ratings Characteristics

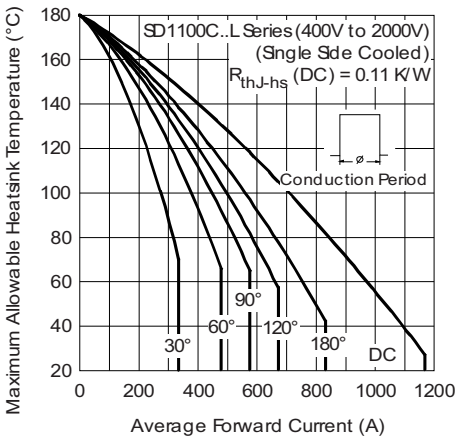

Fig. 2 - Current Ratings Characteristics

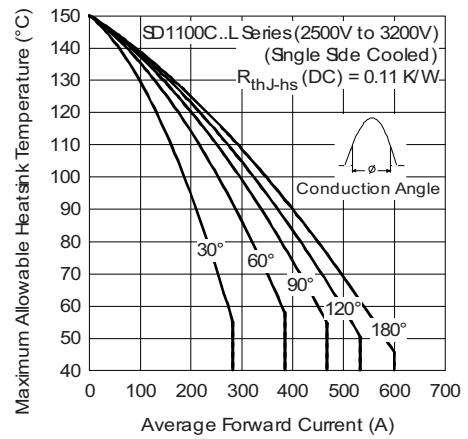

Fig. 5 - Current Ratings Characteristics

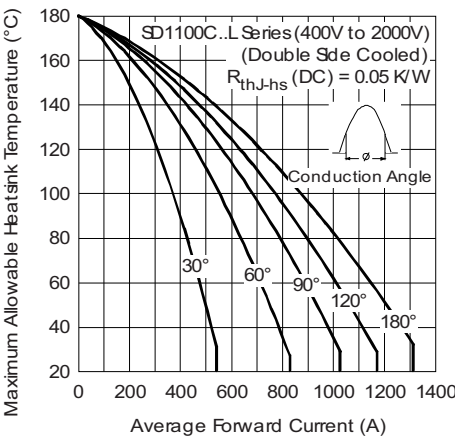

Fig. 3 - Current Ratings Characteristics

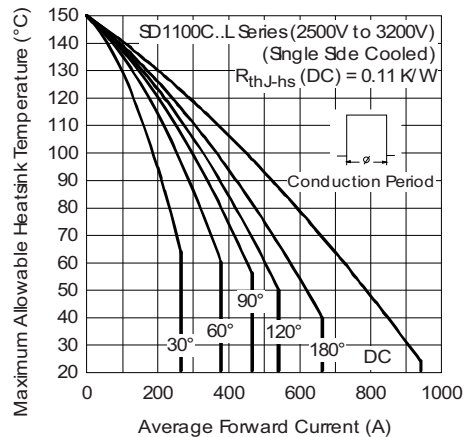

Fig. 6 - Current Ratings Characteristics

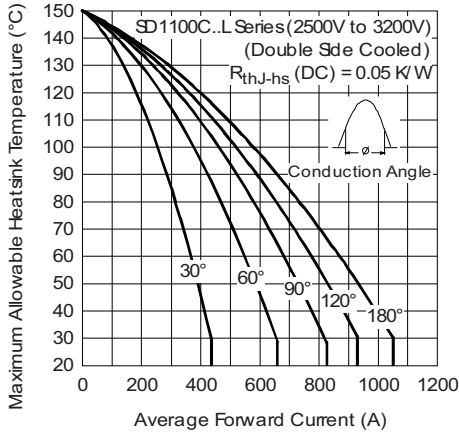

Fig. 7 - Current Ratings Characteristics

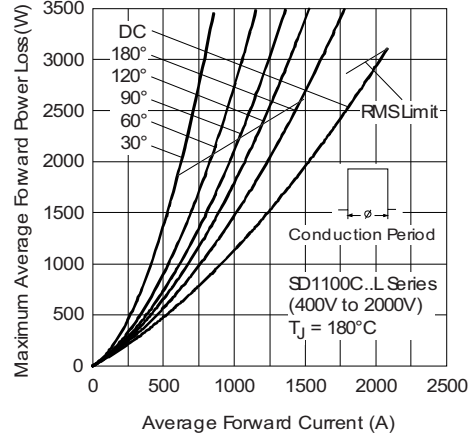

Fig. 10 - Forward Power Loss Characteristics

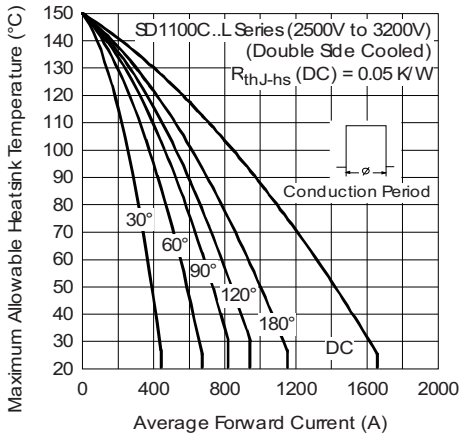

Fig. 8 - Current Ratings Characteristics

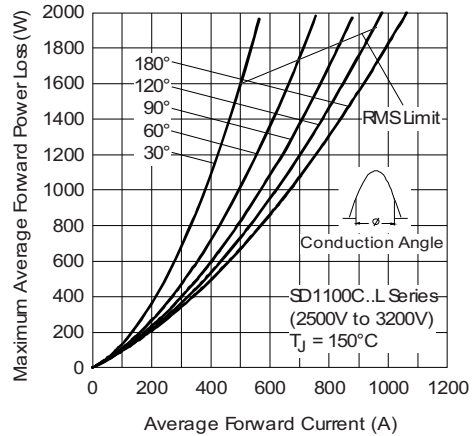

Fig. 11 - Forward Power Loss Characteristics

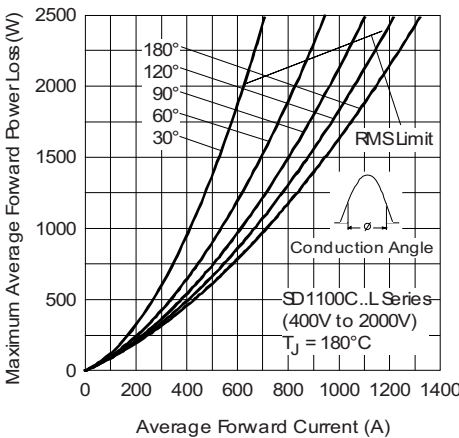

Fig. 9 - Forward Power Loss Characteristics

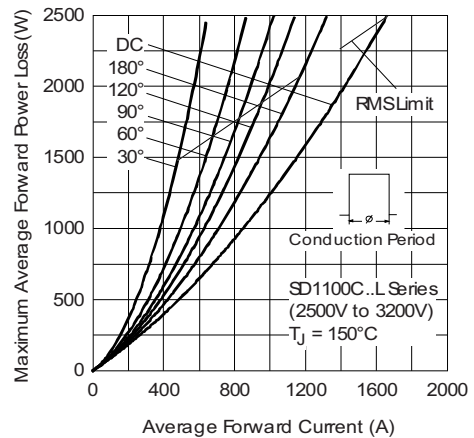

Fig. 12 - Forward Power Loss Characteristics

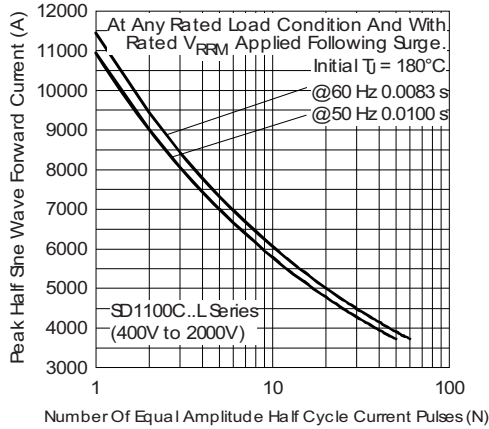

Fig. 13 - Maximum Non-Repetitive Surge Current Single and Double Side Cooled

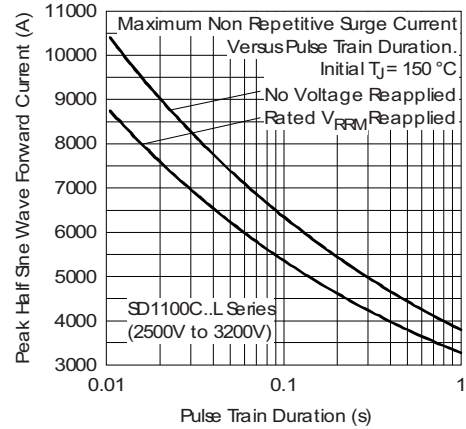

Fig. 16 - Maximum Non-Repetitive Surge Current Single and Double Side Cooled

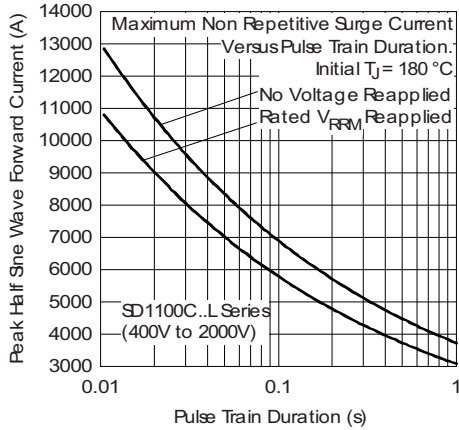

Fig. 14 - Maximum Non-Repetitive Surge Current Single and Double Side Cooled

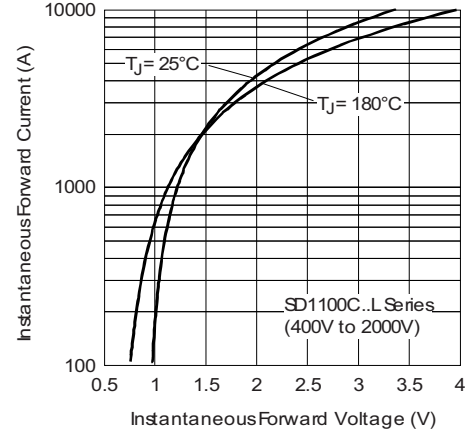

Fig. 17 - Forward Voltage Drop Characteristics

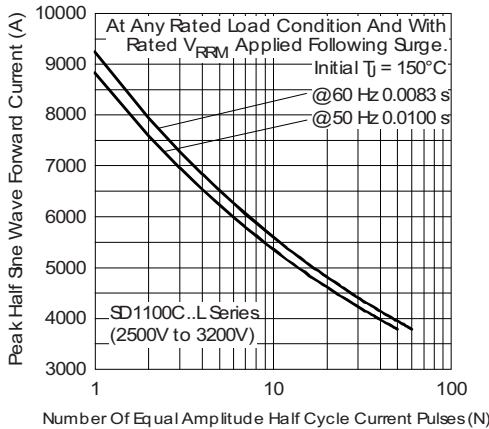

Fig. 15 - Maximum Non-Repetitive Surge Current Single and Double Side Cooled

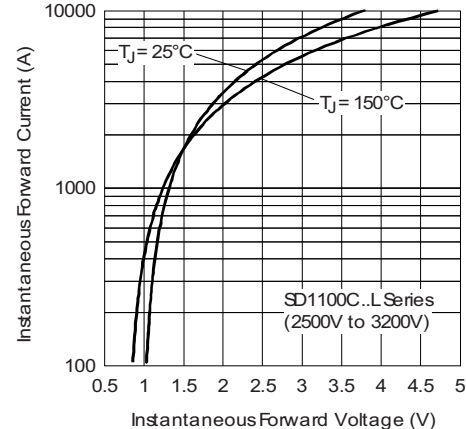

Fig. 18 - Forward Voltage Drop Characteristics

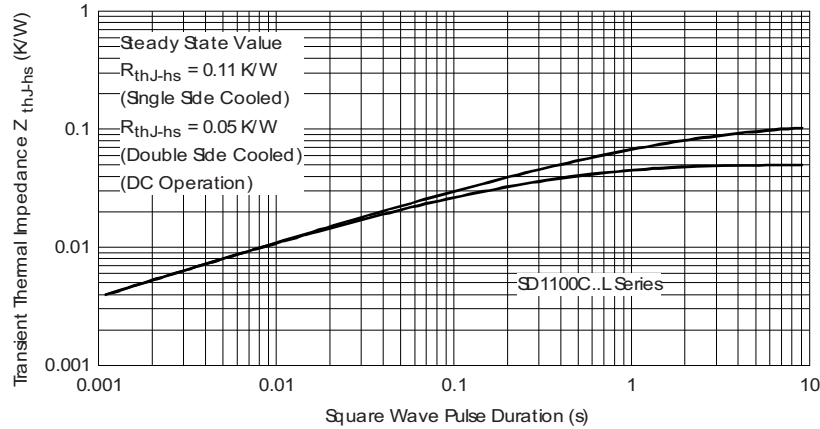

Fig. 19 - Thermal Impedance Z_{thJC} Characteristics

ORDERING INFORMATION TABLE

Device code	VS-	SD	110	0	C	32	L		
	①	②	③	④	⑤	⑥	⑦		
	1	-	Vishay Semiconductors product	2	-	Diode	3	-	Essential part number
	4	-	0 = standard recovery	5	-	C = ceramic PUK	6	-	Voltage code x 100 = V_{RRM} (see Voltage Ratings table)
	7	-	L = PUK case B-PUK (DO-200AB)						

LINKS TO RELATED DOCUMENTS	
Dimensions	www.vishay.com/doc?95246



B-PUK (DO-200AB)

DIMENSIONS in millimeters (inches)

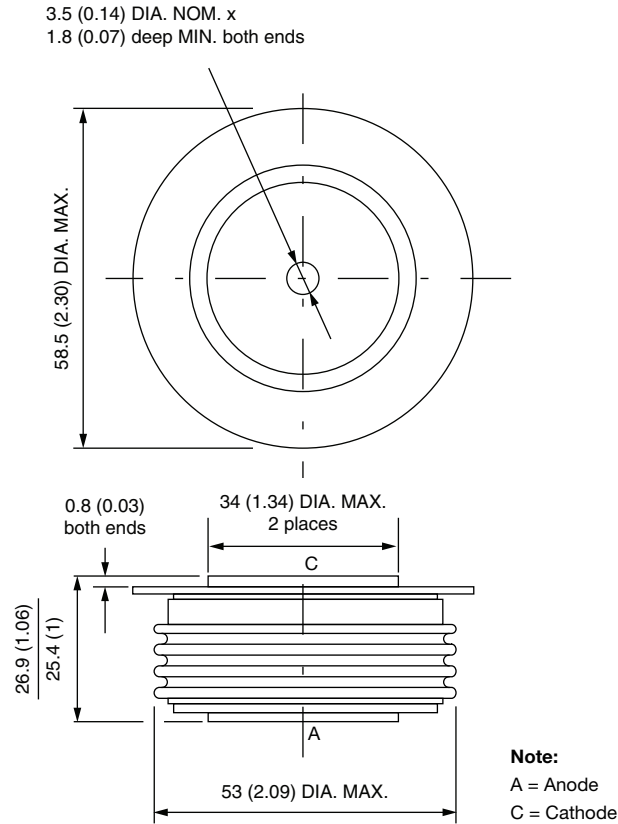

Quote between upper and lower pole pieces has to be considered after application of mounting force (see Thermal and Mechanical Specifications)



Disclaimer

ALL PRODUCT, PRODUCT SPECIFICATIONS AND DATA ARE SUBJECT TO CHANGE WITHOUT NOTICE TO IMPROVE RELIABILITY, FUNCTION OR DESIGN OR OTHERWISE.

Vishay Intertechnology, Inc., its affiliates, agents, and employees, and all persons acting on its or their behalf (collectively, "Vishay"), disclaim any and all liability for any errors, inaccuracies or incompleteness contained in any datasheet or in any other disclosure relating to any product.

Vishay makes no warranty, representation or guarantee regarding the suitability of the products for any particular purpose or the continuing production of any product. To the maximum extent permitted by applicable law, Vishay disclaims (i) any and all liability arising out of the application or use of any product, (ii) any and all liability, including without limitation special, consequential or incidental damages, and (iii) any and all implied warranties, including warranties of fitness for particular purpose, non-infringement and merchantability.

Statements regarding the suitability of products for certain types of applications are based on Vishay's knowledge of typical requirements that are often placed on Vishay products in generic applications. Such statements are not binding statements about the suitability of products for a particular application. It is the customer's responsibility to validate that a particular product with the properties described in the product specification is suitable for use in a particular application. Parameters provided in datasheets and / or specifications may vary in different applications and performance may vary over time. All operating parameters, including typical parameters, must be validated for each customer application by the customer's technical experts. Product specifications do not expand or otherwise modify Vishay's terms and conditions of purchase, including but not limited to the warranty expressed therein.

Hyperlinks included in this datasheet may direct users to third-party websites. These links are provided as a convenience and for informational purposes only. Inclusion of these hyperlinks does not constitute an endorsement or an approval by Vishay of any of the products, services or opinions of the corporation, organization or individual associated with the third-party website. Vishay disclaims any and all liability and bears no responsibility for the accuracy, legality or content of the third-party website or for that of subsequent links.

Except as expressly indicated in writing, Vishay products are not designed for use in medical, life-saving, or life-sustaining applications or for any other application in which the failure of the Vishay product could result in personal injury or death. Customers using or selling Vishay products not expressly indicated for use in such applications do so at their own risk. Please contact authorized Vishay personnel to obtain written terms and conditions regarding products designed for such applications.

No license, express or implied, by estoppel or otherwise, to any intellectual property rights is granted by this document or by any conduct of Vishay. Product names and markings noted herein may be trademarks of their respective owners.

Mouser Electronics

Authorized Distributor

Click to View Pricing, Inventory, Delivery & Lifecycle Information:

[Vishay:](#)

[VS-SD1100C20L](#) [VS-SD1100C08L](#) [VS-SD1100C22C](#) [VS-SD1100C25L](#) [VS-SD1100C32L](#) [VS-SD1100C28J](#) [VS-SD1100C22L](#) [VS-SD1100C04L](#) [VS-SD1100C12L](#) [VS-SD1100C16L](#) [VS-SD1100C32J](#) [VS-SD1100C30L](#)