

## Applications

- Brushed Motor drive applications
- BLDC Motor drive applications
- Battery powered circuits
- Half-bridge and full-bridge topologies
- Synchronous rectifier applications
- Resonant mode power supplies
- OR-ing and redundant power switches
- DC/DC and AC/DC converters
- DC/AC Inverters

## Benefits

- Improved Gate, Avalanche and Dynamic dV/dt Ruggedness
- Fully Characterized Capacitance and Avalanche SOA
- Enhanced body diode dV/dt and dI/dt Capability
- Lead-Free
- Halogen-Free

## HEXFET® Power MOSFET

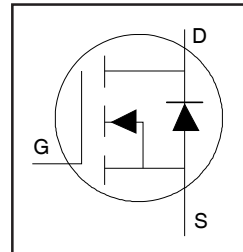

|  |               |
|--|---------------|
| <b>V<sub>DSS</sub></b>                 | <b>40V</b>    |
| <b>R<sub>DS(on)</sub></b> <b>typ.</b>  | <b>2.0mΩ</b>  |
|  | <b>max.</b>   |
| <b>I<sub>D</sub></b>                   | <b>208A</b> Ⓢ |
| <b>I<sub>D</sub> (Package Limited)</b> | <b>120A</b>   |

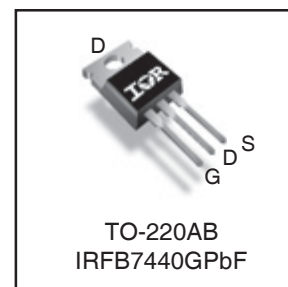

|          |          |          |
|----------|----------|----------|
| <b>G</b> | <b>D</b> | <b>S</b> |
| Gate     | Drain    | Source   |

| Base Part Number | Package Type | Standard Pack |          | Complete Part Number |
|------------------|--------------|---------------|----------|----------------------|
|                  |              | Form          | Quantity |                      |
| IRFB7440GPbF     | TO-220       | Tube          | 50       | IRFB7440GPbF         |

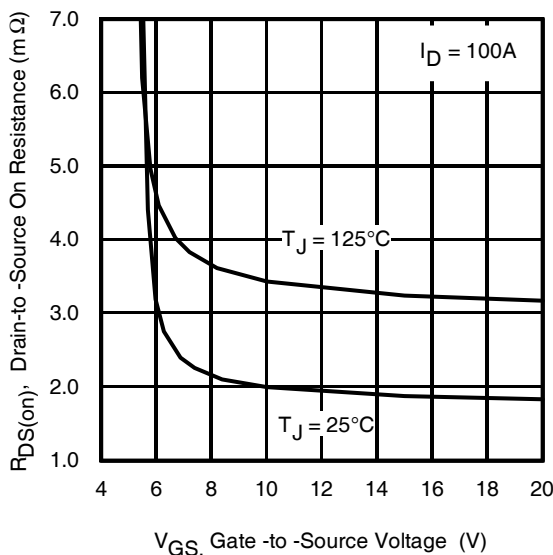

Fig 1. Typical On-Resistance vs. Gate Voltage

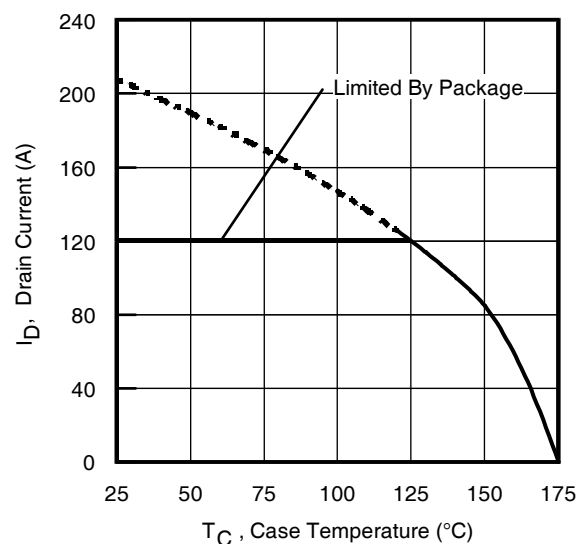

Fig 2. Maximum Drain Current vs. Case Temperature

**Absolute Maximum Ratings**

| Symbol                          | Parameter   | Max.              | Units |
|---------------------------------|---|-------------------|-------|
| $I_D @ T_C = 25^\circ\text{C}$  | Continuous Drain Current, $V_{GS} @ 10\text{V}$                     | 208 <sup>①</sup>  | A     |
| $I_D @ T_C = 100^\circ\text{C}$ | Continuous Drain Current, $V_{GS} @ 10\text{V}$                     | 147 <sup>①</sup>  |       |
| $I_D @ T_C = 25^\circ\text{C}$  | Continuous Drain Current, $V_{GS} @ 10\text{V}$ (Wire Bond Limited) | 120               |       |
| $I_{DM}$                        | Pulsed Drain Current <sup>②</sup>                                   | 772               |       |
| $P_D @ T_C = 25^\circ\text{C}$  | Maximum Power Dissipation   | 208               | W     |
|                                 | Linear Derating Factor  | 1.4               | W/°C  |
| $V_{GS}$                        | Gate-to-Source Voltage  | ± 20              | V     |
| $T_J$                           | Operating Junction and  | -55 to + 175      | °C    |
| $T_{STG}$                       | Storage Temperature Range   |                   |       |
|                                 | Soldering Temperature, for 10 seconds (1.6mm from case)             |                   |       |
|                                 | Mounting torque, 6-32 or M3 screw                                   | 10lbf·in (1.1N·m) |       |

**Avalanche Characteristics**

|                              |  |                           |    |
|------------------------------|--|---------------------------|----|
| $E_{AS}$ (Thermally limited) | Single Pulse Avalanche Energy <sup>③</sup> | 238                       | mJ |
| $E_{AS}$ (Thermally limited) | Single Pulse Avalanche Energy <sup>④</sup> | 560                       |    |
| $I_{AR}$                     | Avalanche Current <sup>②</sup>             | See Fig. 14, 15, 22a, 22b | A  |
| $E_{AR}$                     | Repetitive Avalanche Energy <sup>②</sup>   |                           | mJ |

**Thermal Resistance**

| Symbol          | Parameter                          | Typ. | Max. | Units |
|-----------------|------------------------------------|------|------|-------|
| $R_{\theta JC}$ | Junction-to-Case <sup>⑧</sup>      | —    | 0.72 | °C/W  |
| $R_{\theta CS}$ | Case-to-Sink, Flat Greased Surface | 0.50 | —    |       |
| $R_{\theta JA}$ | Junction-to-Ambient                | —    | 62   |       |

**Static @  $T_J = 25^\circ\text{C}$  (unless otherwise specified)**

| Symbol                          | Parameter                            | Min. | Typ.  | Max. | Units | Conditions   |
|---------------------------------|--------------------------------------|------|-------|------|-------|--|
| $V_{(BR)DSS}$                   | Drain-to-Source Breakdown Voltage    | 40   | —     | —    | V     | $V_{GS} = 0\text{V}$ , $I_D = 250\mu\text{A}$                            |
| $\Delta V_{(BR)DSS}/\Delta T_J$ | Breakdown Voltage Temp. Coefficient  | —    | 0.035 | —    | V/°C  | Reference to $25^\circ\text{C}$ , $I_D = 5.0\text{mA}$ <sup>②</sup>      |
| $R_{DS(on)}$                    | Static Drain-to-Source On-Resistance | —    | 2.0   | 2.5  | mΩ    | $V_{GS} = 10\text{V}$ , $I_D = 100\text{A}$ <sup>⑤</sup>                 |
|                                 |                                      | —    | 3.0   | —    | mΩ    | $V_{GS} = 6.0\text{V}$ , $I_D = 50\text{A}$ <sup>⑤</sup>                 |
| $V_{GS(th)}$                    | Gate Threshold Voltage               | 2.2  | 3.0   | 3.9  | V     | $V_{DS} = V_{GS}$ , $I_D = 100\mu\text{A}$                               |
| $I_{DSS}$                       | Drain-to-Source Leakage Current      | —    | —     | 1.0  | μA    | $V_{DS} = 40\text{V}$ , $V_{GS} = 0\text{V}$                             |
|                                 |                                      | —    | —     | 150  |       | $V_{DS} = 40\text{V}$ , $V_{GS} = 0\text{V}$ , $T_J = 125^\circ\text{C}$ |
| $I_{GSS}$                       | Gate-to-Source Forward Leakage       | —    | —     | 100  | nA    | $V_{GS} = 20\text{V}$  |
|                                 | Gate-to-Source Reverse Leakage       | —    | —     | -100 |       | $V_{GS} = -20\text{V}$   |
| $R_G$                           | Internal Gate Resistance             | —    | 2.6   | —    | Ω     |  |

**Notes:**

- ① Calculated continuous current based on maximum allowable junction temperature. Bond wire current limit is 120A. Note that current limitations arising from heating of the device leads may occur with some lead mounting arrangements. (Refer to AN-1140)
- ② Repetitive rating; pulse width limited by max. junction temperature.
- ③ Limited by  $T_{Jmax}$ , starting  $T_J = 25^\circ\text{C}$ ,  $L = 0.048\text{mH}$ ,  $R_G = 50\Omega$ ,  $I_{AS} = 100\text{A}$ ,  $V_{GS} = 10\text{V}$ .
- ④  $I_{SD} \leq 100\text{A}$ ,  $di/dt \leq 1330\text{A}/\mu\text{s}$ ,  $V_{DD} \leq V_{(BR)DSS}$ ,  $T_J \leq 175^\circ\text{C}$ .
- ⑤ Pulse width  $\leq 400\mu\text{s}$ ; duty cycle  $\leq 2\%$ .
- ⑥  $C_{oss}$  eff. (TR) is a fixed capacitance that gives the same charging time as  $C_{oss}$  while  $V_{DS}$  is rising from 0 to 80%  $V_{DSS}$ .
- ⑦  $C_{oss}$  eff. (ER) is a fixed capacitance that gives the same energy as  $C_{oss}$  while  $V_{DS}$  is rising from 0 to 80%  $V_{DSS}$ .
- ⑧  $R_{\theta}$  is measured at  $T_J$  approximately  $90^\circ\text{C}$ .
- ⑨ Limited by  $T_{Jmax}$  starting  $T_J = 25^\circ\text{C}$ ,  $L = 1\text{mH}$ ,  $R_G = 50\Omega$ ,  $I_{AS} = 34\text{A}$ ,  $V_{GS} = 10\text{V}$ .

**Dynamic @ T<sub>J</sub> = 25°C (unless otherwise specified)**

| Symbol                     | Parameter   | Min. | Typ. | Max. | Units                   | Conditions   |
|----------------------------|---|------|------|------|-------------------------|--|
| g <sub>fs</sub>            | Forward Transconductance                                    | 88   | —    | —    | S                       | V <sub>DS</sub> = 10V, I <sub>D</sub> = 100A                       |
| Q <sub>g</sub>             | Total Gate Charge   | —    | 90   | 135  | nC                      | I <sub>D</sub> = 100A  |
| Q <sub>gs</sub>            | Gate-to-Source Charge                                       | —    | 23   | —    |                         | V <sub>DS</sub> = 20V  |
| Q <sub>gd</sub>            | Gate-to-Drain ("Miller") Charge                             | —    | 32   | —    |                         | V <sub>GS</sub> = 10V ⑤  |
| Q <sub>sync</sub>          | Total Gate Charge Sync. (Q <sub>g</sub> - Q <sub>gd</sub> ) | —    | 58   | —    |                         | I <sub>D</sub> = 100A, V <sub>DS</sub> = 0V, V <sub>GS</sub> = 10V |
| t <sub>d(on)</sub>         | Turn-On Delay Time  | —    | 24   | —    |                         | ns   |
| t <sub>r</sub>             | Rise Time   | —    | 68   | —    | I <sub>D</sub> = 30A    |  |
| t <sub>d(off)</sub>        | Turn-Off Delay Time   | —    | 115  | —    | R <sub>G</sub> = 2.7Ω   |  |
| t <sub>f</sub>             | Fall Time   | —    | 68   | —    | V <sub>GS</sub> = 10V ⑤ |  |
| C <sub>iss</sub>           | Input Capacitance   | —    | 4730 | —    | pF                      | V <sub>GS</sub> = 0V   |
| C <sub>oss</sub>           | Output Capacitance  | —    | 680  | —    |                         | V <sub>DS</sub> = 25V  |
| C <sub>rss</sub>           | Reverse Transfer Capacitance                                | —    | 460  | —    |                         | f = 1.0 MHz  |
| C <sub>oss</sub> eff. (ER) | Effective Output Capacitance (Energy Related)               | —    | 845  | —    |                         | V <sub>GS</sub> = 0V, V <sub>DS</sub> = 0V to 32V ⑦                |
| C <sub>oss</sub> eff. (TR) | Effective Output Capacitance (Time Related)                 | —    | 980  | —    |                         | V <sub>GS</sub> = 0V, V <sub>DS</sub> = 0V to 32V ⑥                |
|                            |   |      |      |      |                         |  |

**Diode Characteristics**

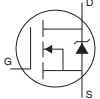
| Symbol           | Parameter                                 | Min. | Typ. | Max. | Units | Conditions   |
|------------------|---|------|------|------|-------|--|
| I <sub>S</sub>   | Continuous Source Current<br>(Body Diode) | —    | —    | 208① | A     | MOSFET symbol showing the integral reverse p-n junction diode.  |
| I <sub>SM</sub>  | Pulsed Source Current<br>(Body Diode) ②   | —    | —    | 772  | A     |  |
| V <sub>SD</sub>  | Diode Forward Voltage                     | —    | 0.9  | 1.3  | V     | T <sub>J</sub> = 25°C, I <sub>S</sub> = 100A, V <sub>GS</sub> = 0V ③   |
| dv/dt            | Peak Diode Recovery ④                     | —    | 6.8  | —    | V/ns  | T <sub>J</sub> = 175°C, I <sub>S</sub> = 100A, V <sub>DS</sub> = 40V   |
| t <sub>rr</sub>  | Reverse Recovery Time                     | —    | 24   | —    | ns    | T <sub>J</sub> = 25°C  |
|                  |   | —    | 28   | —    |       | T <sub>J</sub> = 125°C   |
| Q <sub>rr</sub>  | Reverse Recovery Charge                   | —    | 17   | —    | nC    | T <sub>J</sub> = 25°C  |
|                  |   | —    | 20   | —    |       | T <sub>J</sub> = 125°C   |
| I <sub>RRM</sub> | Reverse Recovery Current                  | —    | 1.3  | —    | A     | T <sub>J</sub> = 25°C  |

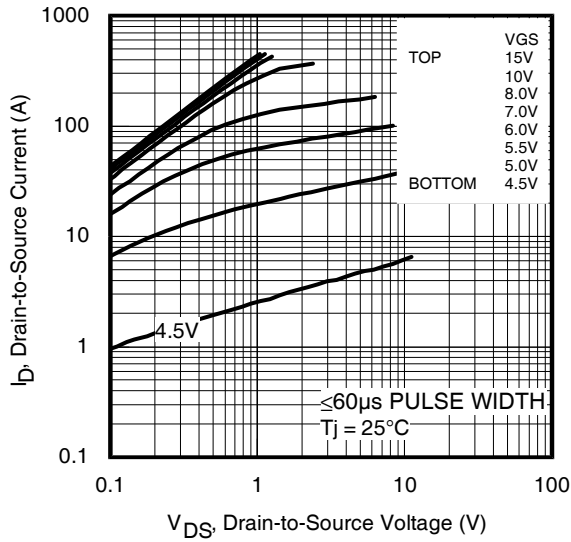
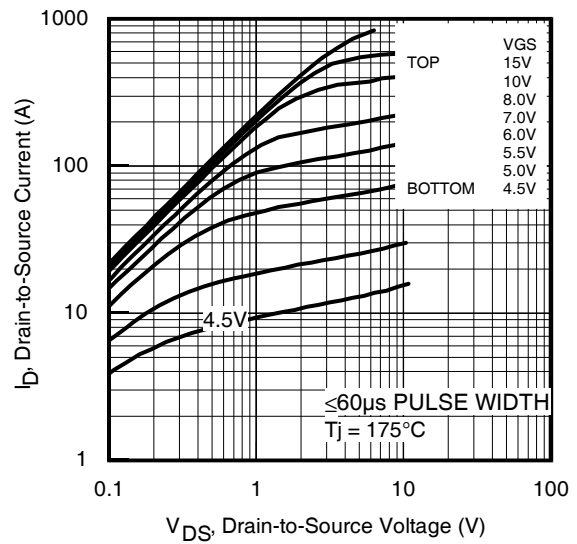
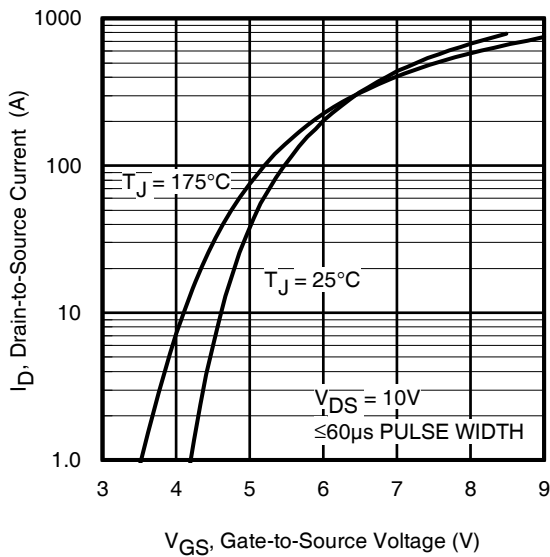
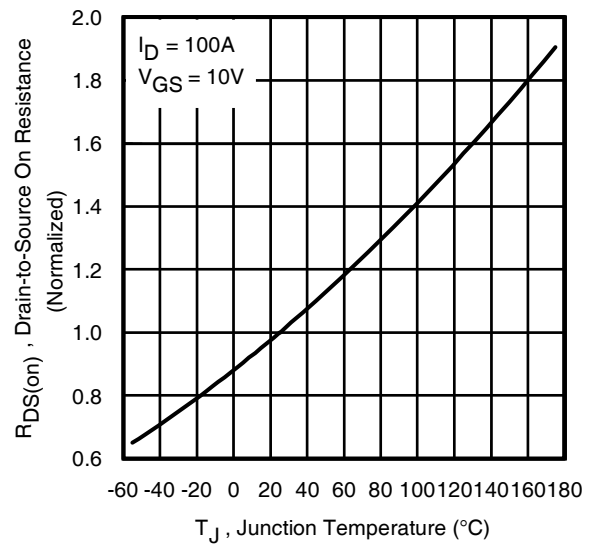
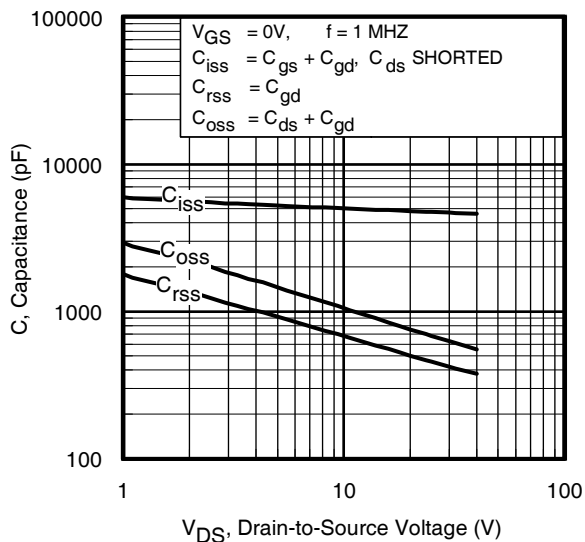
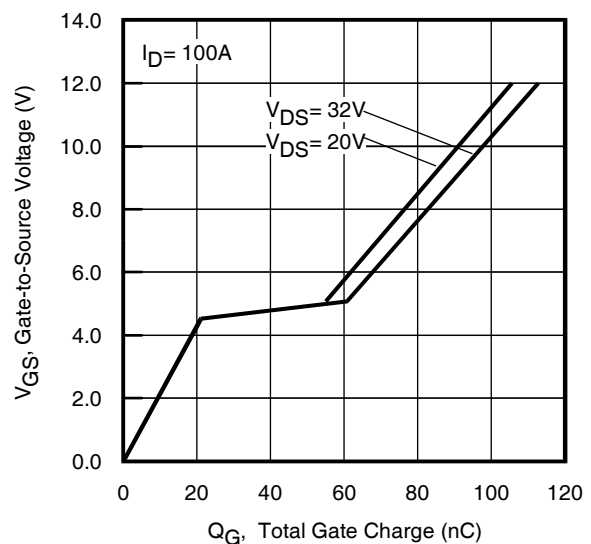
**Fig 3. Typical Output Characteristics**

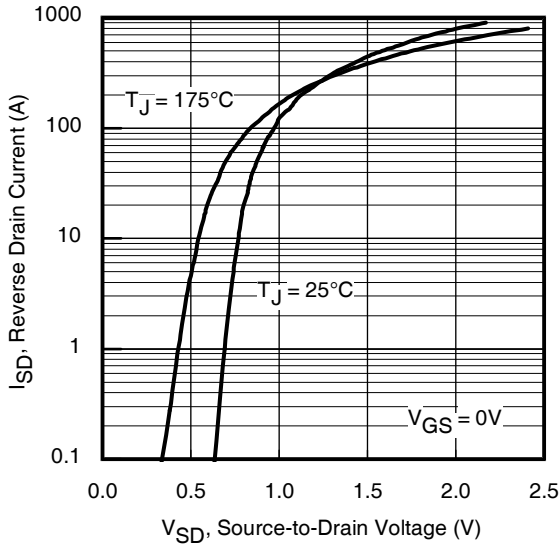
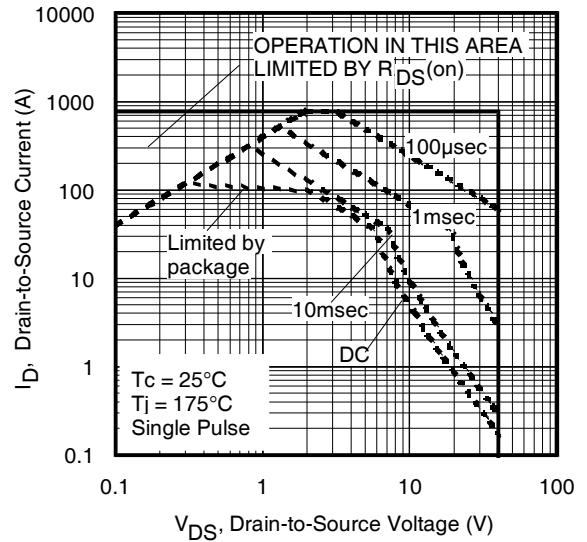
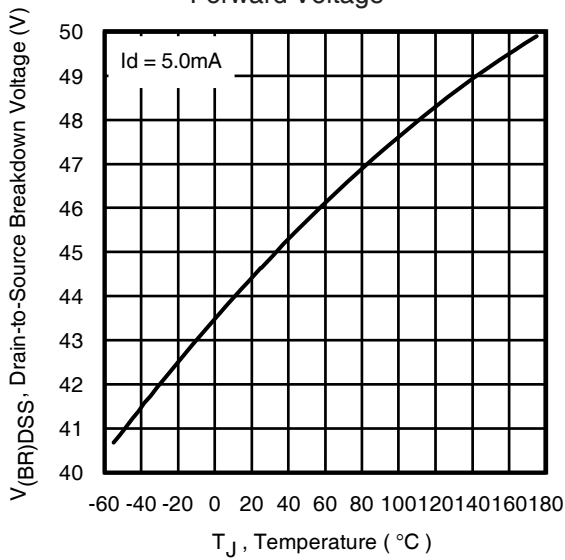
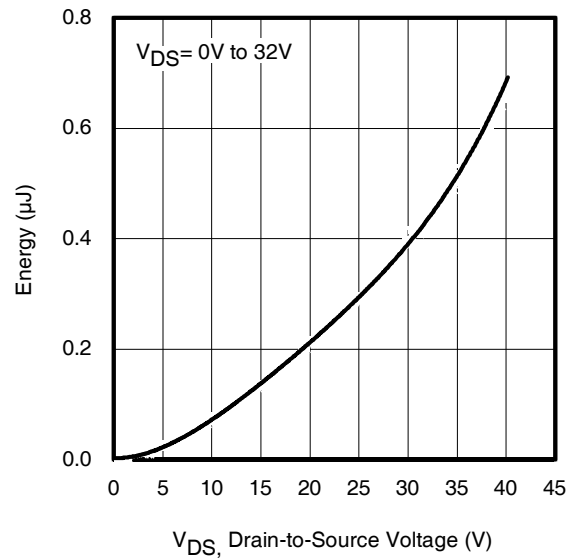
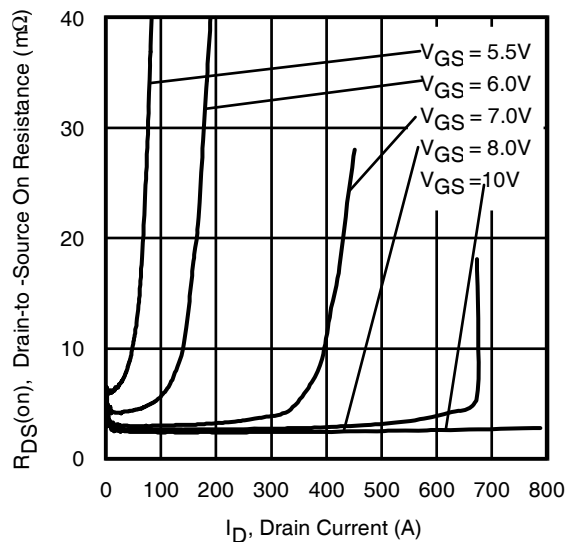
**Fig 4. Typical Output Characteristics**

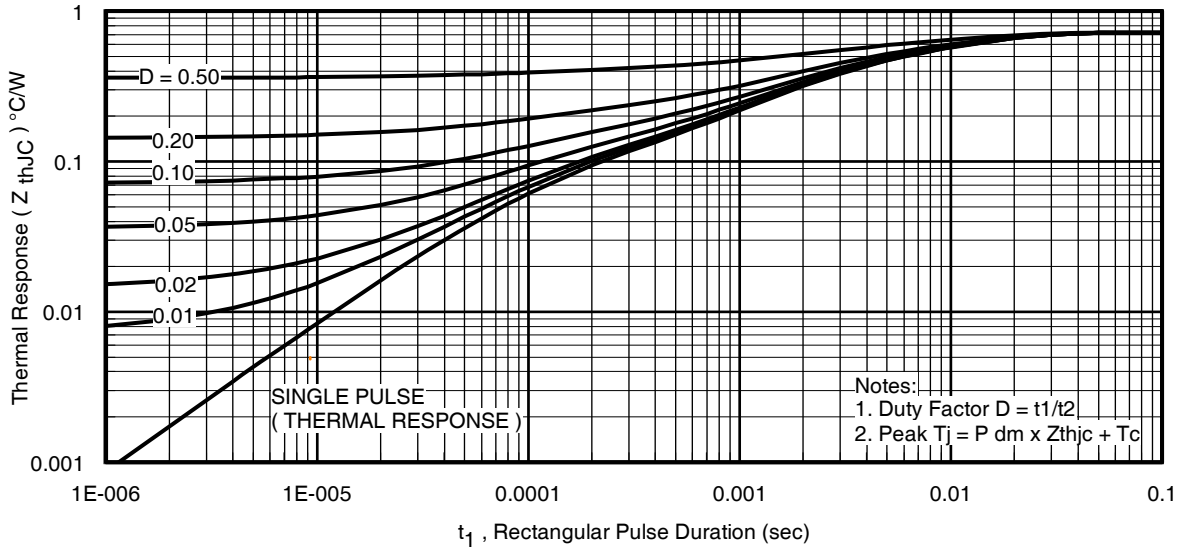
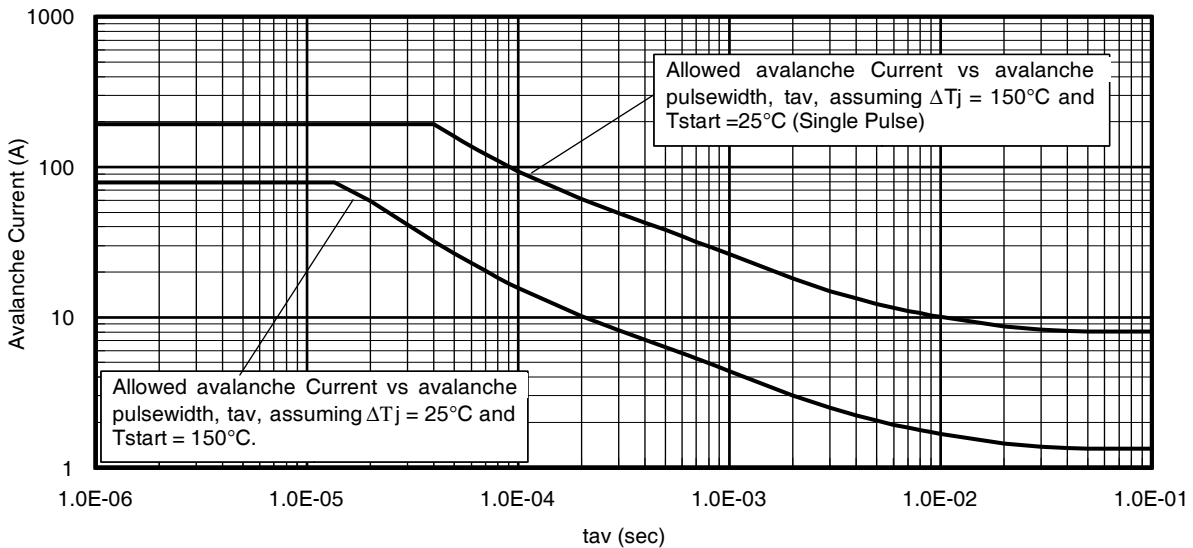
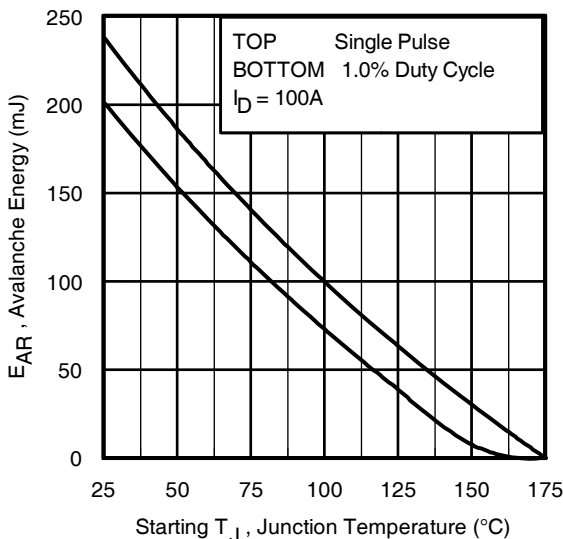
**Fig 5. Typical Transfer Characteristics**

**Fig 6. Normalized On-Resistance vs. Temperature**

**Fig 7. Typical Capacitance vs. Drain-to-Source Voltage**

**Fig 8. Typical Gate Charge vs. Gate-to-Source Voltage**

**Fig 9.** Typical Source-Drain Diode Forward Voltage

**Fig 10.** Maximum Safe Operating Area

**Fig 11.** Drain-to-Source Breakdown Voltage

**Fig 12.** Typical  $C_{OSS}$  Stored Energy

**Fig 13.** Typical On-Resistance vs. Drain Current

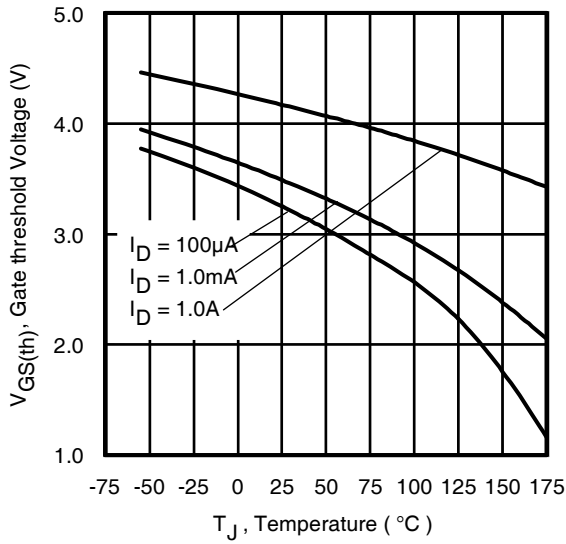
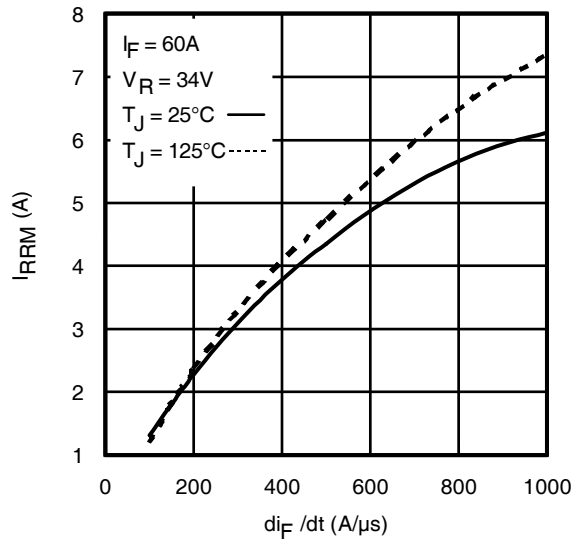
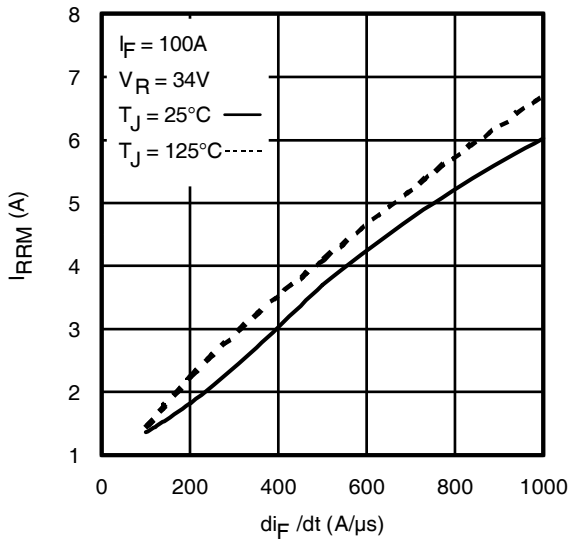
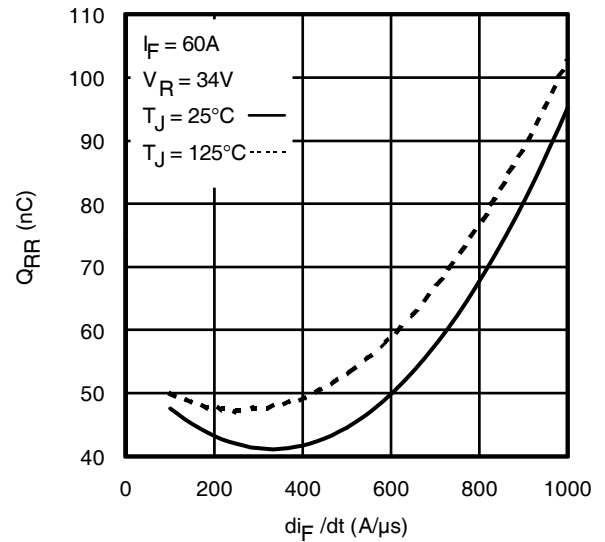
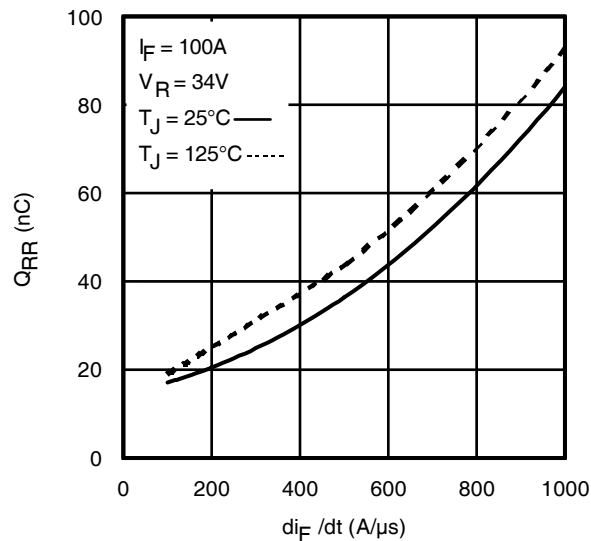

**Fig 14. Maximum Effective Transient Thermal Impedance, Junction-to-Case**

**Fig 15. Typical Avalanche Current vs. Pulsewidth**

**Fig 16. Maximum Avalanche Energy vs. Temperature**
**Notes on Repetitive Avalanche Curves , Figures 14, 15:  
(For further info, see AN-1005 at www.irf.com)**

1. Avalanche failures assumption:  
Purely a thermal phenomenon and failure occurs at a temperature far in excess of  $T_{jmax}$ . This is validated for every part type.
2. Safe operation in Avalanche is allowed as long as  $T_{jmax}$  is not exceeded.
3. Equation below based on circuit and waveforms shown in Figures 16a, 16b.
4.  $P_{D(ave)}$  = Average power dissipation per single avalanche pulse.
5.  $BV$  = Rated breakdown voltage (1.3 factor accounts for voltage increase during avalanche).
6.  $I_{av}$  = Allowable avalanche current.
7.  $\Delta T$  = Allowable rise in junction temperature, not to exceed  $T_{jmax}$  (assumed as 25°C in Figure 14, 15).  
 $t_{av}$  = Average time in avalanche.  
 $D$  = Duty cycle in avalanche =  $t_{av} \cdot f$   
 $Z_{thJC}(D, t_{av})$  = Transient thermal resistance, see Figures 13)

$$P_{D(ave)} = 1/2 ( 1.3 \cdot BV \cdot I_{av} ) = \Delta T / Z_{thJC}$$

$$I_{av} = 2\Delta T / [ 1.3 \cdot BV \cdot Z_{th} ]$$

$$E_{AS(AR)} = P_{D(ave)} \cdot t_{av}$$

**Fig 17. Threshold Voltage vs. Temperature**

**Fig. 18 - Typical Recovery Current vs.  $di_f/dt$** 

**Fig. 19 - Typical Recovery Current vs.  $di_f/dt$** 

**Fig. 20 - Typical Stored Charge vs.  $di_f/dt$** 

**Fig. 21 - Typical Stored Charge vs.  $di_f/dt$**



\*  $V_{GS} = 5V$  for Logic Level Devices

**Fig 22. Peak Diode Recovery dv/dt Test Circuit for N-Channel HEXFET® Power MOSFETs**



**Fig 22a. Unclamped Inductive Test Circuit**



**Fig 22b. Unclamped Inductive Waveforms**



**Fig 23a. Switching Time Test Circuit**

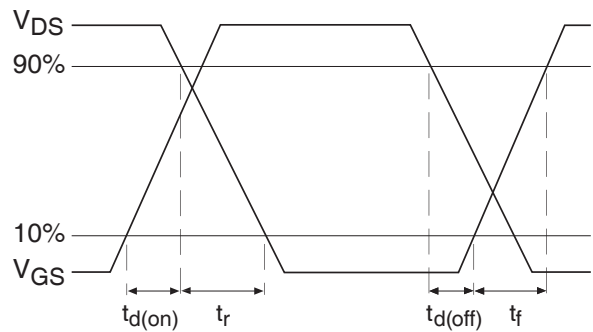

**Fig 23b. Switching Time Waveforms**



**Fig 24a. Gate Charge Test Circuit**

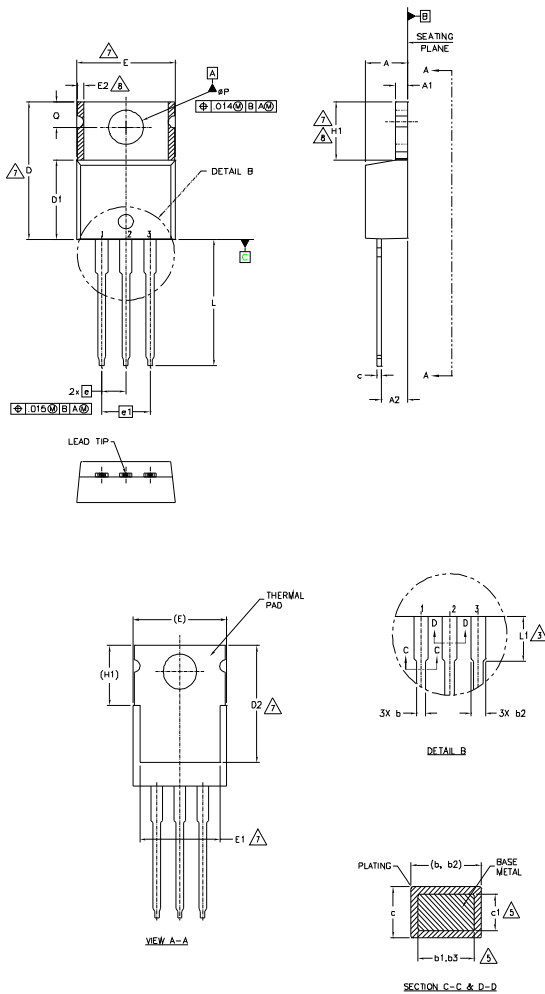

**Fig 24b. Gate Charge Waveform**



## TO-220AB Package Outline

Dimensions are shown in millimeters (inches)



**NOTES:**

- 1.- DIMENSIONING AND TOLERANCING AS PER ASME Y14.5 M- 1994.
- 2.- DIMENSIONS ARE SHOWN IN INCHES [MILLIMETERS]
- 3.- LEAD DIMENSION AND FINISH UNCONTROLLED IN L1.
- 4.- DIMENSION D, D1 & E DO NOT INCLUDE MOLD FLASH. MOLD FLASH SHALL NOT EXCEED .005" (0.127) PER SIDE. THESE DIMENSIONS ARE MEASURED AT THE OUTERMOST EXTREMES OF THE PLASTIC BODY.
- 5.- DIMENSION b1, b3 & c1 APPLY TO BASE METAL ONLY.
- 6.- CONTROLLING DIMENSION : INCHES.
- 7.- THERMAL PAD CONTOUR OPTIONAL WITHIN DIMENSIONS E,H1,D2 & E1
- 8.- DIMENSION E2 x H1 DEFINE A ZONE WHERE STAMPING AND SINGULATION IRREGULARITIES ARE ALLOWED.
- 9.- OUTLINE CONFORMS TO JEDEC TO-220, EXCEPT A2 (max.) AND D2 (min.) WHERE DIMENSIONS ARE DERIVED FROM THE ACTUAL PACKAGE OUTLINE.

| SYMBOL | DIMENSIONS  |       |          |      | NOTES |
|--------|-------------|-------|----------|------|-------|
|        | MILLIMETERS |       | INCHES   |      |       |
|        | MIN.        | MAX.  | MIN.     | MAX. |       |
| A      | 3.56        | 4.83  | .140     | .190 |       |
| A1     | 1.14        | 1.40  | .045     | .055 |       |
| A2     | 2.03        | 2.92  | .080     | .115 |       |
| b      | 0.38        | 1.01  | .015     | .040 |       |
| b1     | 0.38        | 0.97  | .015     | .038 | 5     |
| b2     | 1.14        | 1.78  | .045     | .070 |       |
| b3     | 1.14        | 1.73  | .045     | .068 | 5     |
| c      | 0.36        | 0.61  | .014     | .024 |       |
| c1     | 0.36        | 0.56  | .014     | .022 | 5     |
| D      | 14.22       | 16.51 | .560     | .650 | 4     |
| D1     | 8.38        | 9.02  | .330     | .355 |       |
| D2     | 11.68       | 12.88 | .460     | .507 | 7     |
| E      | 9.65        | 10.67 | .380     | .420 | 4,7   |
| E1     | 6.86        | 8.89  | .270     | .350 | 7     |
| E2     | -           | 0.76  | -        | .030 | 8     |
| e      | 2.54 BSC    |       | .100 BSC |      |       |
| e1     | 5.08 BSC    |       | .200 BSC |      |       |
| H1     | 5.84        | 6.86  | .230     | .270 | 7,8   |
| L      | 12.70       | 14.73 | .500     | .580 |       |
| L1     | 3.56        | 4.06  | .140     | .160 | 3     |
| øP     | 3.54        | 4.08  | .139     | .161 |       |
| Q      | 2.54        | 3.42  | .100     | .135 |       |

**LEAD ASSIGNMENTS**

**HEXFET**

- 1.- GATE
- 2.- DRAIN
- 3.- SOURCE

**IGBTs, CoPACK**

- 1.- GATE
- 2.- COLLECTOR
- 3.- EMITTER

**DIODES**

- 1.- ANODE
- 2.- CATHODE
- 3.- ANODE

## TO-220AB Part Marking Information

EXAMPLE: THIS IS AN IRFB4310GPBF

Note: "G" suffix in part number indicates "Halogen - Free"

Note: "P" in assembly line position indicates "Lead - Free"

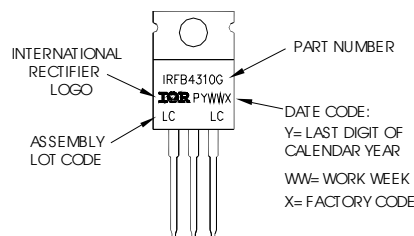

TO-220AB packages are not recommended for Surface Mount Application.

Note: For the most current drawing please refer to IR website at <http://www.irf.com/package/>

**Qualification information<sup>†</sup>**

|                            |  |                |
|----------------------------|--|----------------|
| Qualification level        | Industrial<br>(per JEDEC JESD47F <sup>††</sup> guidelines) |                |
| Moisture Sensitivity Level | TO-220   | Not applicable |
| RoHS compliant             | Yes  |                |

† Qualification standards can be found at International Rectifier's web site: <http://www.irf.com/product-info/reliability/>

†† Applicable version of JEDEC standard at the time of product release.

**Revision History**

| Date       | Comment  |
|------------|--|
| 11/19/2014 | <ul style="list-style-type: none"> <li>• Updated data sheet with IR corporate template.</li> <li>• Updated <math>E_{AS(L=1mH)} = 560mJ</math> on page 2</li> <li>• Updated note 9 "Limited by <math>T_{Jmax}</math>, starting <math>T_J = 25^{\circ}C</math>, <math>L = 1mH</math>, <math>R_G = 50\Omega</math>, <math>I_{AS} = 34A</math>, <math>V_{GS} = 10V</math>". on page 2</li> <li>• Updated package outline on page 9.</li> </ul> |

## **IMPORTANT NOTICE**

The information given in this document shall in no event be regarded as a guarantee of conditions or characteristics ("Beschaffenheitsgarantie").

With respect to any examples, hints or any typical values stated herein and/or any information regarding the application of the product, Infineon Technologies hereby disclaims any and all warranties and liabilities of any kind, including without limitation warranties of non-infringement of intellectual property rights of any third party.

In addition, any information given in this document is subject to customer's compliance with its obligations stated in this document and any applicable legal requirements, norms and standards concerning customer's products and any use of the product of Infineon Technologies in customer's applications.

The data contained in this document is exclusively intended for technically trained staff. It is the responsibility of customer's technical departments to evaluate the suitability of the product for the intended application and the completeness of the product information given in this document with respect to such application.

For further information on the product, technology, delivery terms and conditions and prices please contact your nearest Infineon Technologies office ([www.infineon.com](http://www.infineon.com)).

## **WARNINGS**

Due to technical requirements products may contain dangerous substances. For information on the types in question please contact your nearest Infineon Technologies office.

Except as otherwise explicitly approved by Infineon Technologies in a written document signed by authorized representatives of Infineon Technologies, Infineon Technologies' products may not be used in any applications where a failure of the product or any consequences of the use thereof can reasonably be expected to result in personal injury.