



Dual INT-A-PAK Low Profile 3-Level Half Bridge Inverter Stage, 300 A



FEATURES

- Trench plus Field Stop IGBT technology
- FRED Pt® antiparallel and clamping diodes
- Short circuit capability
- Low stray internal inductances
- Low switching loss
- UL approved file E78996 
- Material categorization: for definitions of compliance please see www.vishay.com/doc?99912



RoHS COMPLIANT

PRIMARY CHARACTERISTICS	
V_{CES}	600 V
$V_{CE(on)}$ typical at $I_C = 300$ A	1.72 V
I_C at $T_C = 25$ °C	379 A
Speed	8 kHz to 30 kHz
Package	Dual INT-A-PAK low profile
Circuit configuration	3-level half bridge inverter stage

APPLICATION

- Solar converters
- Uninterruptible power supplies

BENEFITS

- Direct mounting on heatsink
- Low junction to case thermal resistance
- Easy paralleling due to positive T_C of $V_{CE(sat)}$

ABSOLUTE MAXIMUM RATINGS				
PARAMETER	SYMBOL	TEST CONDITIONS	MAX.	UNITS
Operating junction temperature	T_J		175	°C
Storage temperature range	T_{Stg}		-40 to +175	
RMS isolation voltage	V_{ISOL}	$T_J = 25$ °C, all terminals shorted, $f = 50$ Hz, $t = 1$ s	3500	V
Collector to emitter voltage	V_{CES}		600	
Gate to emitter voltage	V_{GES}		20	
Pulsed collector current	I_{CM}		650	A
Clamped inductive load current	I_{LM}		650	
Continuous collector current	I_C	$T_C = 25$ °C	379	
		$T_C = 80$ °C	288	
Power dissipation	P_D	$T_C = 25$ °C	1250	W
		$T_C = 80$ °C	792	
D5 - D6 CLAMPING DIODE				
Repetitive peak reverse voltage	V_{RRM}		600	V
Single pulse forward current	I_{FSM}	10 ms sine or 6 ms rectangular pulse, $T_J = 25$ °C	800	A
Diode continuous forward current	I_F	$T_C = 25$ °C	215	
		$T_C = 80$ °C	161	
Power dissipation	P_D	$T_C = 25$ °C	500	W
		$T_C = 80$ °C	317	
D - D2 - D3 - D4 AP DIODE				
Single pulse forward current	I_{FSM}	10 ms sine or 6 ms rectangular pulse, $T_J = 25$ °C	800	A
Diode continuous forward current	I_F	$T_C = 25$ °C	215	
		$T_C = 80$ °C	161	
Power dissipation	P_D	$T_C = 25$ °C	500	W
		$T_C = 80$ °C	317	

Note

- Absolute Maximum Ratings indicate sustained limits beyond which damage to the device may occur



ELECTRICAL SPECIFICATIONS ($T_J = 25\text{ }^\circ\text{C}$ unless otherwise noted)						
PARAMETER	SYMBOL	TEST CONDITIONS	MIN.	TYP.	MAX.	UNITS
Q1 - Q2 - Q3 - Q4 TRENCH IGBT						
Collector to emitter breakdown voltage	BV_{CES}	$V_{GE} = 0\text{ V}, I_C = 500\text{ }\mu\text{A}$	600	-	-	V
Collector to emitter voltage	$V_{CE(on)}$	$V_{GE} = 15\text{ V}, I_C = 300\text{ A}$	-	1.72	2.5	
		$V_{GE} = 15\text{ V}, I_C = 300\text{ A}, T_J = 125\text{ }^\circ\text{C}$	-	1.93	-	
Gate threshold voltage	$V_{GE(th)}$	$V_{CE} = V_{GE}, I_C = 16.8\text{ mA}$	2.9	4.8	7.5	
Temperature coefficient of threshold voltage	$\Delta V_{GE(th)}/\Delta T_J$	$V_{CE} = V_{GE}, I_C = 1\text{ mA}$ (25 °C to 125 °C)	-	-17.8	-	mV/°C
Forward transconductance	g_{fe}	$V_{CE} = 20\text{ V}, I_C = 300\text{ A}$	-	315	-	S
Transfer characteristics	V_{GE}	$V_{CE} = 20\text{ V}, I_C = 300\text{ A}$	-	7.9	-	V
Zero gate voltage collector current	I_{CES}	$V_{GE} = 0\text{ V}, V_{CE} = 600\text{ V}$	-	0.4	250	μA
		$V_{GE} = 0\text{ V}, V_{CE} = 600\text{ V}, T_J = 125\text{ }^\circ\text{C}$	-	300	-	
Gate to emitter leakage current	I_{GES}	$V_{GE} = \pm 20\text{ V}, V_{CE} = 0\text{ V}$	-	-	± 500	nA
D5 - D6 CLAMPING DIODE						
Cathode to anode blocking voltage	V_{BR}	$I_R = 100\text{ }\mu\text{A}$	600	-	-	V
Forward voltage drop	V_{FM}	$I_F = 150\text{ A}$	-	2.17	2.7	
		$I_F = 150\text{ A}, T_J = 125\text{ }^\circ\text{C}$	-	1.61	-	
Reverse leakage current	I_{RM}	$V_R = 600\text{ V}$	-	0.25	200	μA
		$V_R = 600\text{ V}, T_J = 125\text{ }^\circ\text{C}$	-	140	-	
D1 - D2 - D3 - D4 AP DIODE						
Forward voltage drop	V_{FM}	$I_F = 150\text{ A}$	-	2.17	2.7	V
		$I_F = 150\text{ A}, T_J = 125\text{ }^\circ\text{C}$	-	1.61	-	

SWITCHING CHARACTERISTICS ($T_J = 25\text{ }^\circ\text{C}$ unless otherwise noted)						
PARAMETER	SYMBOL	TEST CONDITIONS	MIN.	TYP.	MAX.	UNITS
Q1 - Q2 - Q3 - Q4 TRENCH IGBT						
Total gate charge (turn-on)	Q_g	$I_C = 300\text{ A}$	-	750	-	nC
Gate to emitter charge (turn-on)	Q_{ge}	$V_{CC} = 400\text{ V}$	-	210	-	
Gate to collector charge (turn-on)	Q_{gc}	$V_{GE} = 15\text{ V}$	-	300	-	
Turn-on switching loss	E_{on}	$I_C = 150\text{ A}, V_{CC} = 300\text{ V}$ $V_{GE} = 15\text{ V}, R_g = 10\text{ }\Omega$ $L = 500\text{ }\mu\text{H}, T_J = 25\text{ }^\circ\text{C}$	-	2.1	-	mJ
Turn-off switching loss	E_{off}		-	3.1	-	
Total switching loss	E_{tot}		-	5.2	-	
Turn-on switching loss	E_{on}	$I_C = 300\text{ A}, V_{CC} = 300\text{ V}$ $V_{GE} = 15\text{ V}, R_g = 22\text{ }\Omega$ $L = 500\text{ }\mu\text{H}, T_J = 25\text{ }^\circ\text{C}$	-	8.6	-	
Turn-off switching loss	E_{off}		-	15.4	-	
Total switching loss	E_{tot}		-	24	-	
Turn-on switching loss	E_{on}	$I_C = 150\text{ A}$ $V_{CC} = 300\text{ V}$ $V_{GE} = 15\text{ V}$ $R_g = 10\text{ }\Omega$ $L = 500\text{ }\mu\text{H}$ $T_J = 125\text{ }^\circ\text{C}$	-	2.6	-	ns
Turn-off switching loss	E_{off}		-	3.7	-	
Total switching loss	E_{tot}		-	6.3	-	
Turn-on delay time	$t_{d(on)}$	-	453	-		
Rise time	t_r	-	120	-		
Turn-off delay time	$t_{d(off)}$	-	366	-		
Fall time	t_f	-	119	-		



SWITCHING CHARACTERISTICS ($T_J = 25\text{ }^\circ\text{C}$ unless otherwise noted)						
PARAMETER	SYMBOL	TEST CONDITIONS	MIN.	TYP.	MAX.	UNITS
Q1 - Q2 - Q3 - Q4 TRENCH IGBT						
Turn-on switching loss	E_{on}	$I_C = 300\text{ A}$ $V_{CC} = 300\text{ V}$ $V_{GE} = 15\text{ V}$	-	10.7	-	mJ
Turn-off switching loss	E_{off}		-	15.6	-	
Total switching loss	E_{tot}		-	26.3	-	
Turn-on delay time	$t_{d(on)}$	$R_g = 22\text{ }\Omega$ $L = 500\text{ }\mu\text{H}$ $T_J = 125\text{ }^\circ\text{C}$	-	840	-	ns
Rise time	t_r		-	279	-	
Turn-off delay time	$t_{d(off)}$		-	566	-	
Fall time	t_f		-	129	-	
Input capacitance	C_{ies}	$V_{GE} = 0\text{ V}$	-	23.3	-	nF
Output capacitance	C_{oes}	$V_{CC} = 30\text{ V}$	-	1.7	-	
Reverse transfer capacitance	C_{res}	$f = 1\text{ MHz}$	-	0.7	-	
Reverse bias safe operating area	RBSOA	$T_J = 175\text{ }^\circ\text{C}$, $I_C = 650\text{ A}$ $V_{CC} = 270\text{ V}$, $V_P = 600\text{ V}$ $R_g = 22\text{ }\Omega$, $V_{GE} = 15\text{ V to }0\text{ V}$				
Short circuit safe operating area	SCSOA	$V_{CC} = 400\text{ V}$, $V_P = 600\text{ V}$ $R_g = 10\text{ }\Omega$, $V_{GE} = 15\text{ V to }0\text{ V}$	-	-	5.0	μs
D5 - D6 CLAMPING DIODE						
Diode reverse recovery time	t_{rr}	$V_R = 200\text{ V}$ $I_F = 50\text{ A}$ $di/dt = 500\text{ A}/\mu\text{s}$	-	105	-	ns
Diode peak reverse current	I_{rr}		-	13.5	-	A
Diode recovery charge	Q_{rr}		-	712	-	nC
Diode reverse recovery time	t_{rr}	$V_R = 200\text{ V}$ $I_F = 50\text{ A}$ $di/dt = 500\text{ A}/\mu\text{s}$, $T_J = 125\text{ }^\circ\text{C}$	-	166	-	ns
Diode peak reverse current	I_{rr}		-	24.5	-	A
Diode recovery charge	Q_{rr}		-	2050	-	nC
D1 - D2 - D3 - D4 AP DIODE						
Diode reverse recovery time	t_{rr}	$V_R = 200\text{ V}$ $I_F = 50\text{ A}$ $di/dt = 500\text{ A}/\mu\text{s}$	-	105	-	ns
Diode peak reverse current	I_{rr}		-	13.5	-	A
Diode recovery charge	Q_{rr}		-	712	-	nC
Diode reverse recovery time	t_{rr}	$V_R = 200\text{ V}$ $I_F = 50\text{ A}$ $di/dt = 500\text{ A}/\mu\text{s}$, $T_J = 125\text{ }^\circ\text{C}$	-	166	-	ns
Diode peak reverse current	I_{rr}		-	24.5	-	A
Diode recovery charge	Q_{rr}		-	2050	-	nC

THERMAL AND MECHANICAL SPECIFICATIONS					
PARAMETER	SYMBOL	MIN.	TYP.	MAX.	UNITS
Junction to case IGBT thermal resistance (per switch)	R_{thJC}	-	-	0.12	$^\circ\text{C}/\text{W}$
Junction to case diode thermal resistance (per diode)		-	-	0.3	
Case to sink, flat, greased surface (per module)	R_{thCS}	-	0.05	-	
Mounting torque, case to heatsink: M6 screw		4	-	6	Nm
Mounting torque, case to terminal: 1, 2, 3, 4: M5 screw		2	-	5	
Weight		-	270	-	g

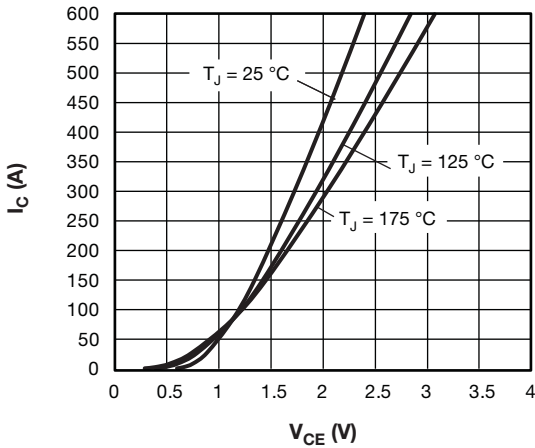

Fig. 1 - Typical Trench IGBT Output Characteristics, $V_{GE} = 15\text{ V}$

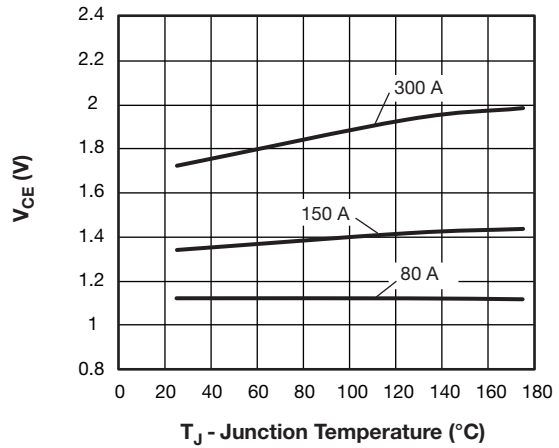

Fig. 4 - Typical Trench IGBT Collector to Emitter Voltage vs. Junction Temperature, $V_{GE} = 15\text{ V}$

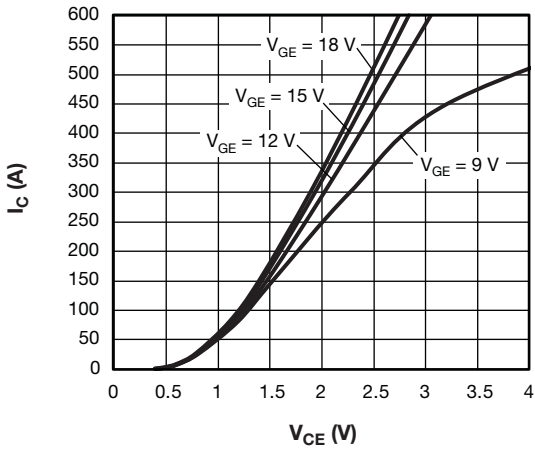

Fig. 2 - Typical Trench IGBT Output Characteristics, $T_J = 125\text{ °C}$

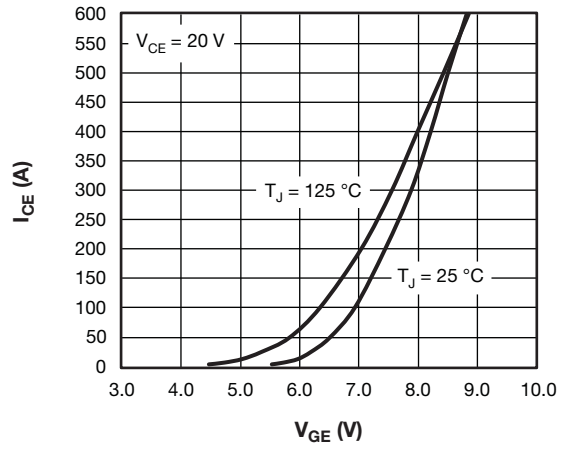

Fig. 5 - Typical Trench IGBT Transfer Characteristics

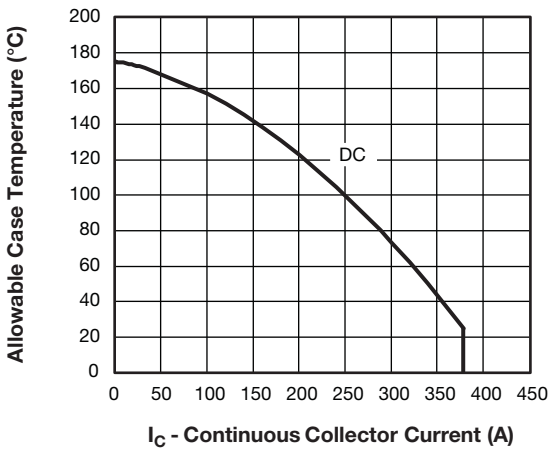

Fig. 3 - Maximum Trench IGBT Continuous Collector Current vs. Case Temperature (per switch)

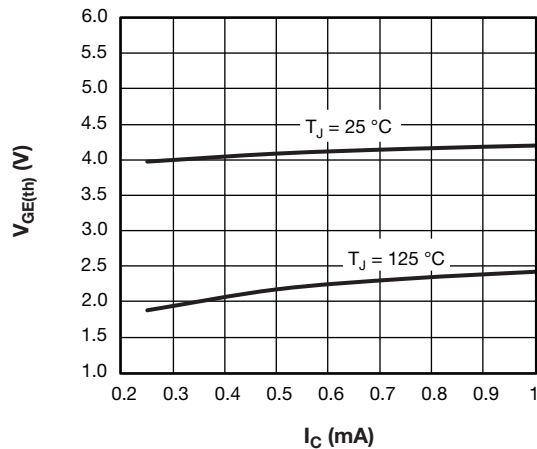

Fig. 6 - Typical Trench IGBT Gate Threshold Voltage

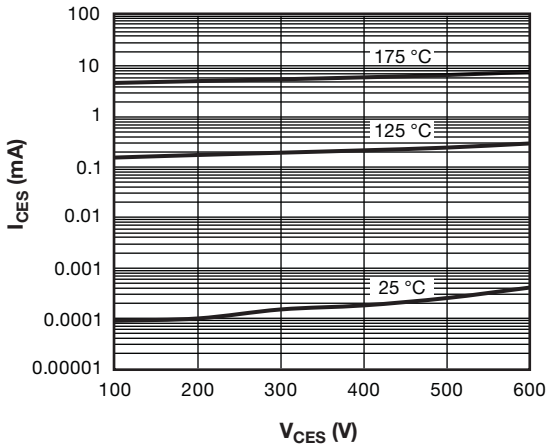

Fig. 7 - Typical Trench IGBT Zero Gate Voltage Collector Current

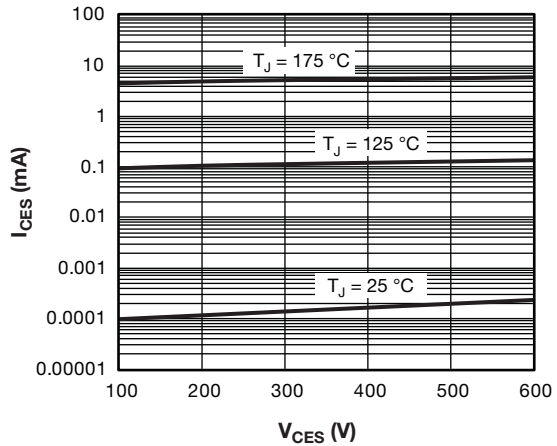

Fig. 10 - Typical Diode Reverse Leakage Current

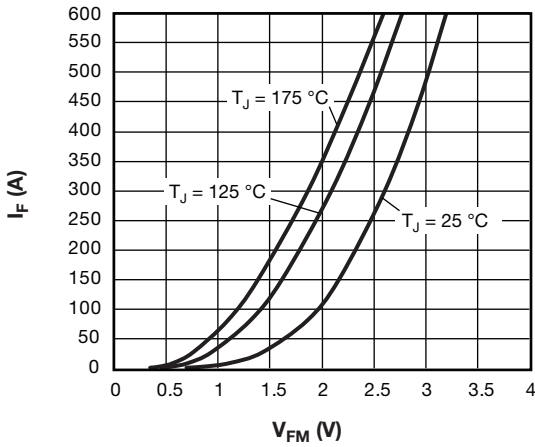

Fig. 8 - Typical Diode Forward Characteristics

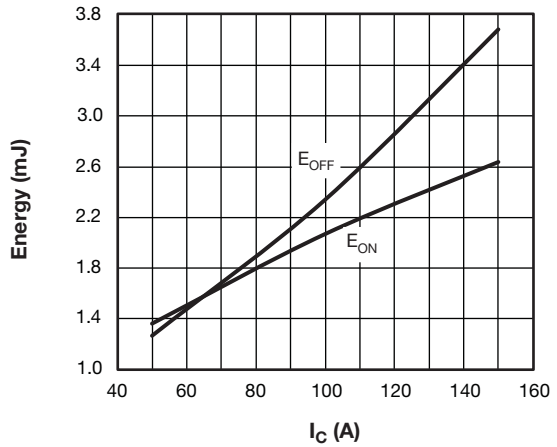

Fig. 11 - Typical Trench IGBT Energy Loss vs. I_C , $T_J = 125\text{ }^\circ\text{C}$, $V_{CC} = 300\text{ V}$, $R_g = 10\ \Omega$, $V_{GE} = 15\text{ V}$, $L = 500\ \mu\text{H}$

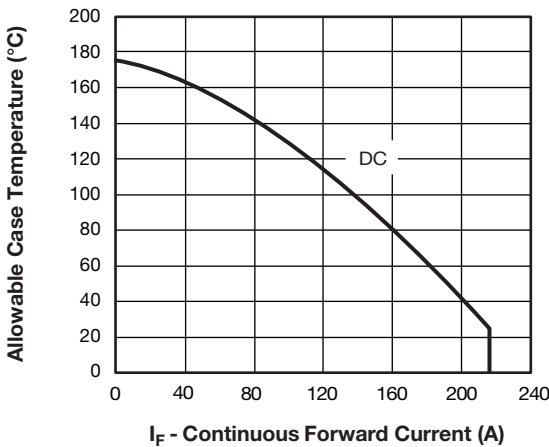

Fig. 9 - Maximum Diode Forward Current vs. Case Temperature

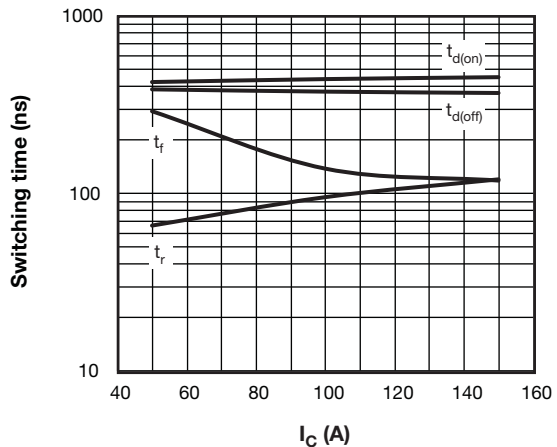

Fig. 12 - Typical IGBT Switching Time vs. I_C , $T_J = 125\text{ }^\circ\text{C}$, $V_{CC} = 300\text{ V}$, $R_g = 10\ \Omega$, $V_{GE} = 15\text{ V}$, $L = 500\ \mu\text{H}$

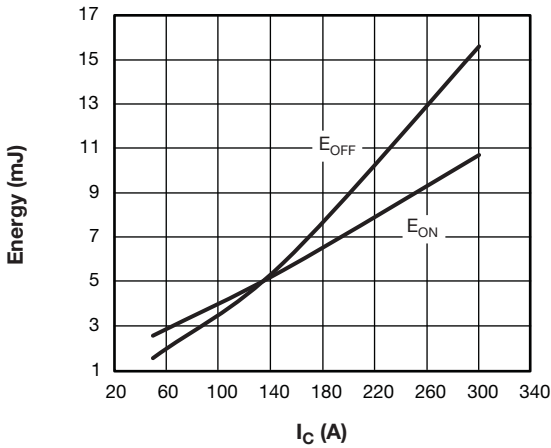

Fig. 13 - Typical Trench IGBT Energy Loss vs. I_C ,
 $T_J = 125^\circ\text{C}$, $V_{CC} = 300\text{ V}$, $R_g = 22\ \Omega$, $V_{GE} = 15\text{ V}$, $L = 500\ \mu\text{H}$

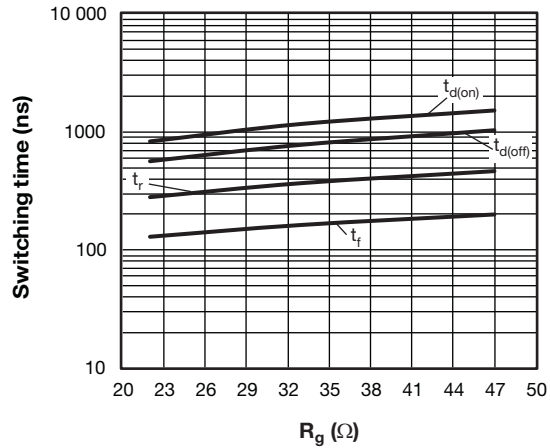

Fig. 16 - Typical Trench IGBT Switching Time vs. R_g ,
 $T_J = 125^\circ\text{C}$, $V_{CC} = 300\text{ V}$, $I_C = 300\text{ A}$, $V_{GE} = 15\text{ V}$, $L = 500\ \mu\text{H}$

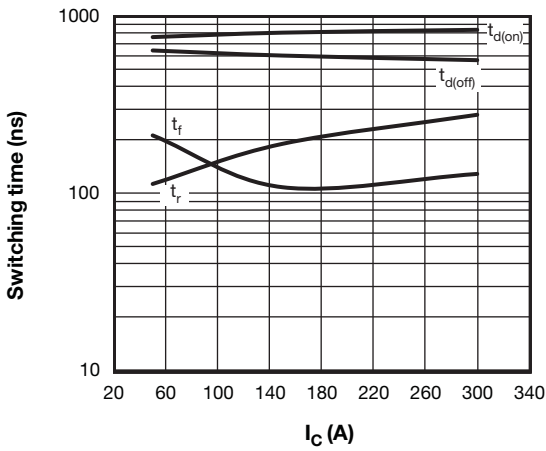

Fig. 14 - Typical IGBT Switching Time vs. I_C ,
 $T_J = 125^\circ\text{C}$, $V_{CC} = 300\text{ V}$, $R_g = 22\ \Omega$, $V_{GE} = 15\text{ V}$, $L = 500\ \mu\text{H}$

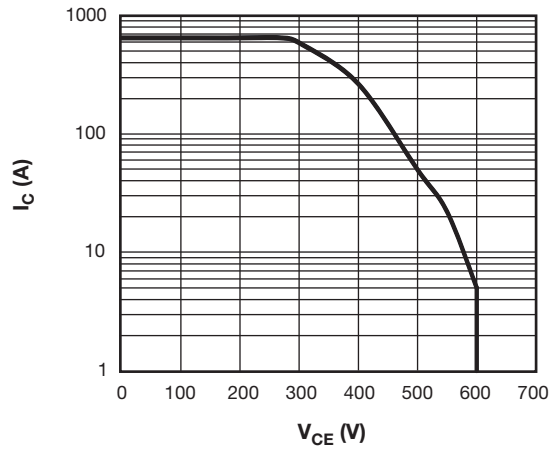

Fig. 17 - Trench IGBT Reverse Bias SOA
 $T_J = 175^\circ\text{C}$, $V_{GE} = 15\text{ V}$, $R_g = 22\ \Omega$

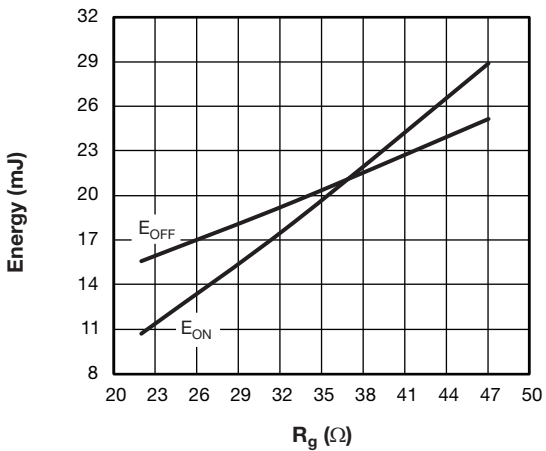

Fig. 15 - Typical Trench IGBT Energy Loss vs. R_g ,
 $T_J = 125^\circ\text{C}$, $V_{CC} = 300\text{ V}$, $I_C = 300\text{ A}$, $V_{GE} = 15\text{ V}$, $L = 500\ \mu\text{H}$

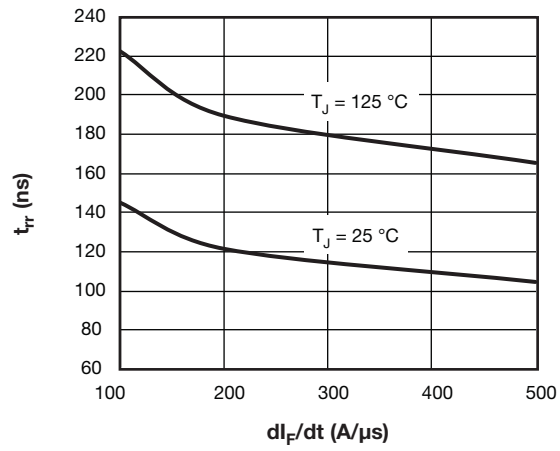

Fig. 18 - Typical Diode Reverse Recovery Time vs. dI_F/dt ,
 $V_{rr} = 200\text{ V}$, $I_F = 50\text{ A}$

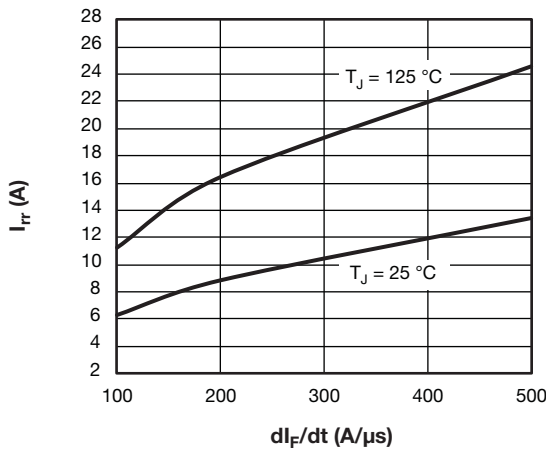

Fig. 19 - Typical Diode Reverse Recovery Current vs. di_F/dt , $V_{rr} = 200\text{ V}$, $I_F = 50\text{ A}$

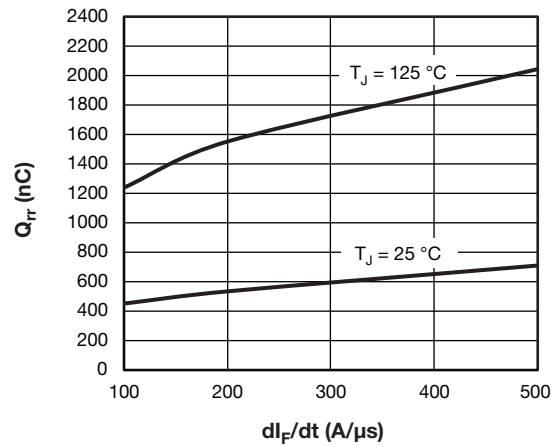

Fig. 20 - Typical Diode Reverse Recovery Charge vs. di_F/dt , $V_{rr} = 200\text{ V}$, $I_F = 50\text{ A}$

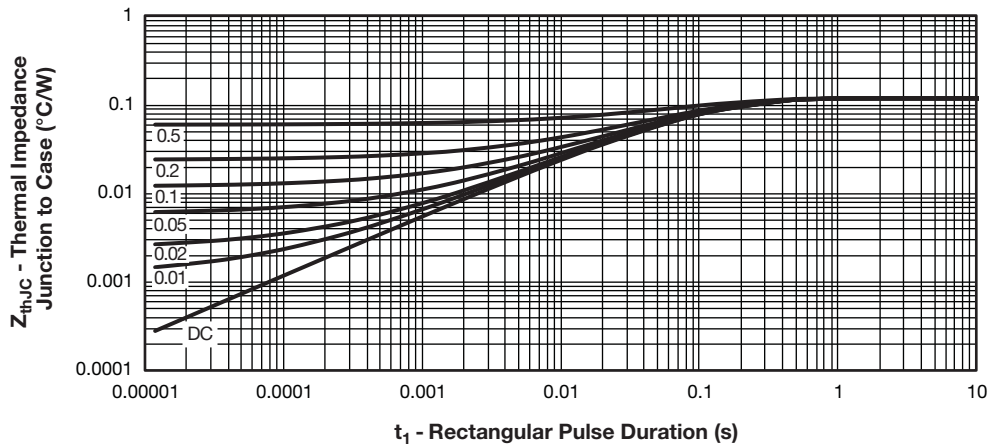

Fig. 21 - Maximum Thermal Impedance Z_{thJC} Characteristics (Trench IGBT)

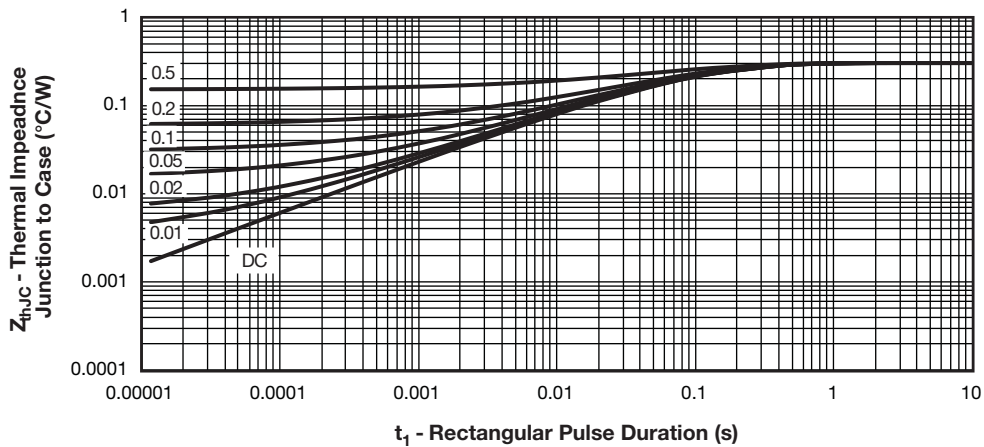
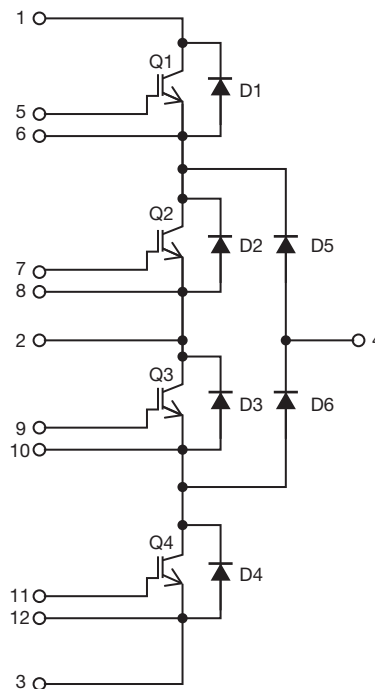

Fig. 22 - Maximum Thermal Impedance Z_{thJC} Characteristics (Diode)

ORDERING INFORMATION TABLE

Device code	VS-	G	T	300	F	D	060	N
	①	②	③	④	⑤	⑥	⑦	⑧

- 1** - Vishay Semiconductors product
- 2** - Insulated gate bipolar transistor
- 3** - T = trench IGBT
- 4** - Current rating (300 = 300 A)
- 5** - F = 3-level circuit configuration
- 6** - Package indicator D = dual INT-A-PAK low profile
- 7** - Voltage rating (060 = 600 V)
- 8** - N = ultrafast

CIRCUIT CONFIGURATION

LINKS TO RELATED DOCUMENTS

Dimensions

www.vishay.com/doc?95515



DIAP Low Profile - 4 Leads

DIMENSIONS in millimeters

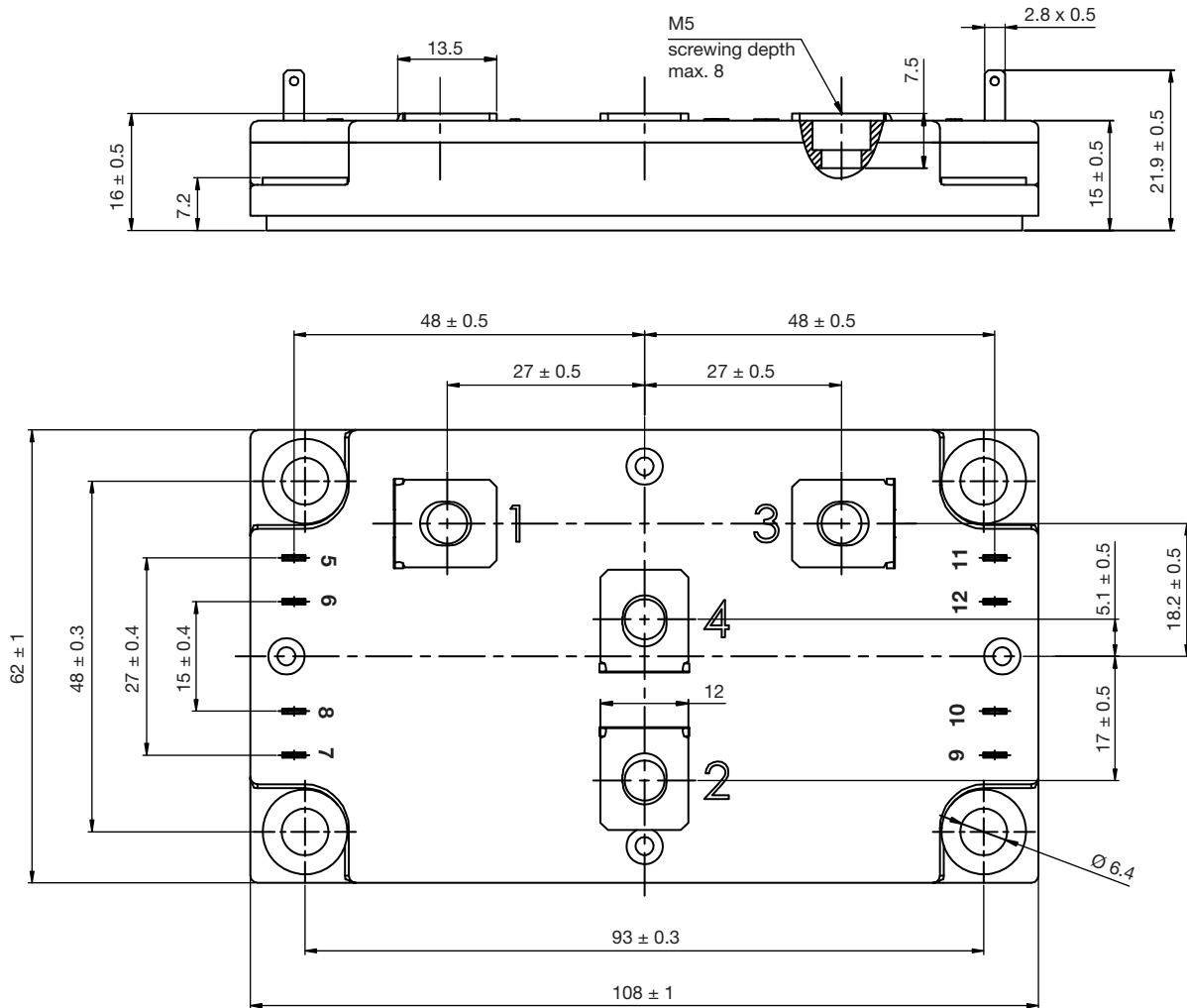



Disclaimer

ALL PRODUCT, PRODUCT SPECIFICATIONS AND DATA ARE SUBJECT TO CHANGE WITHOUT NOTICE TO IMPROVE RELIABILITY, FUNCTION OR DESIGN OR OTHERWISE.

Vishay Intertechnology, Inc., its affiliates, agents, and employees, and all persons acting on its or their behalf (collectively, "Vishay"), disclaim any and all liability for any errors, inaccuracies or incompleteness contained in any datasheet or in any other disclosure relating to any product.

Vishay makes no warranty, representation or guarantee regarding the suitability of the products for any particular purpose or the continuing production of any product. To the maximum extent permitted by applicable law, Vishay disclaims (i) any and all liability arising out of the application or use of any product, (ii) any and all liability, including without limitation special, consequential or incidental damages, and (iii) any and all implied warranties, including warranties of fitness for particular purpose, non-infringement and merchantability.

Statements regarding the suitability of products for certain types of applications are based on Vishay's knowledge of typical requirements that are often placed on Vishay products in generic applications. Such statements are not binding statements about the suitability of products for a particular application. It is the customer's responsibility to validate that a particular product with the properties described in the product specification is suitable for use in a particular application. Parameters provided in datasheets and / or specifications may vary in different applications and performance may vary over time. All operating parameters, including typical parameters, must be validated for each customer application by the customer's technical experts. Product specifications do not expand or otherwise modify Vishay's terms and conditions of purchase, including but not limited to the warranty expressed therein.

Hyperlinks included in this datasheet may direct users to third-party websites. These links are provided as a convenience and for informational purposes only. Inclusion of these hyperlinks does not constitute an endorsement or an approval by Vishay of any of the products, services or opinions of the corporation, organization or individual associated with the third-party website. Vishay disclaims any and all liability and bears no responsibility for the accuracy, legality or content of the third-party website or for that of subsequent links.

Except as expressly indicated in writing, Vishay products are not designed for use in medical, life-saving, or life-sustaining applications or for any other application in which the failure of the Vishay product could result in personal injury or death. Customers using or selling Vishay products not expressly indicated for use in such applications do so at their own risk. Please contact authorized Vishay personnel to obtain written terms and conditions regarding products designed for such applications.

No license, express or implied, by estoppel or otherwise, to any intellectual property rights is granted by this document or by any conduct of Vishay. Product names and markings noted herein may be trademarks of their respective owners.