

MJF122, MJF127

Complementary Power Darlington

For Isolated Package Applications

Designed for general-purpose amplifiers and switching applications, where the mounting surface of the device is required to be electrically isolated from the heatsink or chassis.

Features

- Electrically Similar to the Popular TIP122 and TIP127
- 100 V_{CEO(sus)}
- 5.0 A Rated Collector Current
- No Isolating Washers Required
- Reduced System Cost
- High DC Current Gain – 2000 (Min) @ I_C = 3 Adc
- UL Recognized, File #E69369, to 3500 V_{RMS} Isolation
- Pb-Free Packages are Available*

MAXIMUM RATINGS

Rating	Symbol	Value	Unit
Collector-Emitter Voltage	V _{CEO}	100	Vdc
Collector-Base Voltage	V _{CB}	100	Vdc
Emitter-Base Voltage	V _{EB}	5	Vdc
RMS Isolation Voltage (Note 1) (t = 0.3 sec, R.H. ≤ 30%, T _A = 25°C) Per Figure 14	V _{ISOL}	4500	V _{RMS}
Collector Current – Continuous Peak	I _C	5 8	Adc
Base Current	I _B	0.12	Adc
Total Power Dissipation (Note 2) @ T _C = 25°C Derate above 25°C	P _D	30 0.24	W W/°C
Total Power Dissipation @ T _A = 25°C Derate above 25°C	P _D	2 0.016	W W/°C
Operating and Storage Junction Temperature Range	T _J , T _{stg}	-65 to +150	I _C

THERMAL CHARACTERISTICS

Characteristic	Symbol	Max	Unit
Thermal Resistance, Junction-to-Ambient	R _{θJA}	62.5	°C/W
Thermal Resistance, Junction-to-Case (Note 2)	R _{θJC}	4.1	°C/W
Lead Temperature for Soldering Purpose	T _L	260	°C

Maximum ratings are those values beyond which device damage can occur. Maximum ratings applied to the device are individual stress limit values (not normal operating conditions) and are not valid simultaneously. If these limits are exceeded, device functional operation is not implied, damage may occur and reliability may be affected.

1. Proper strike and creepage distance must be provided.
2. Measurement made with thermocouple contacting the bottom insulated mounting surface (in a location beneath the die), the device mounted on a heatsink with thermal grease and a mounting torque of ≥ 6 in. lbs.



ON Semiconductor®

<http://onsemi.com>

COMPLEMENTARY SILICON POWER DARLINGTONS 5.0 A, 100 V, 30 W

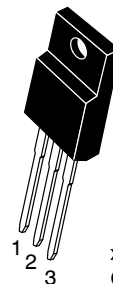
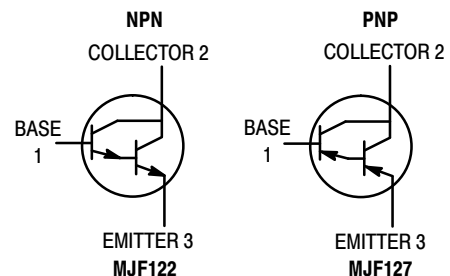

MARKING DIAGRAM

TO-220
CASE 221D-02
STYLE 2

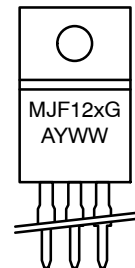

x = 2 or 7
G = Pb-Free Package
A = Assembly Location
Y = Year
WW = Work Week

ORDERING INFORMATION

Device	Package	Shipping†
MJF122	TO-220	50 Units / Rail
MJF122G	TO-220 (Pb-Free)	50 Units / Rail
MJF127	TO-220	50 Units / Rail
MJF127G	TO-220 (Pb-Free)	50 Units / Rail

†For information on tape and reel specifications, including part orientation and tape sizes, please refer to our Tape and Reel Packaging Specifications Brochure, BRD8011/D.

*For additional information on our Pb-Free strategy and soldering details, please download the ON Semiconductor Soldering and Mounting Techniques Reference Manual, SOLDERRM/D.

MJF122, MJF127

ELECTRICAL CHARACTERISTICS (T_C = 25°C unless otherwise noted)

Characteristic	Symbol	Min	Max	Unit
OFF CHARACTERISTICS				
Collector–Emitter Sustaining Voltage (Note 3) (I _C = 100 mAdc, I _B = 0)	V _{CEO(sus)}	100	–	Vdc
Collector Cutoff Current (V _{CE} = 50 Vdc, I _B = 0)	I _{CEO}	–	10	μAdc
Collector Cutoff Current (V _{CB} = 100 Vdc, I _E = 0)	I _{CBO}	–	10	μAdc
Emitter Cutoff Current (V _{BE} = 5 Vdc, I _C = 0)	I _{EBO}	–	2	mAdc
ON CHARACTERISTICS (Note 3)				
DC Current Gain (I _C = 0.5 Adc, V _{CE} = 3 Vdc) (I _C = 3 Adc, V _{CE} = 3 Vdc)	h _{FE}	1000 2000	– –	–
Collector–Emitter Saturation Voltage (I _C = 3 Adc, I _B = 12 mAdc) (I _C = 5 Adc, I _B = 20 mAdc)	V _{CE(sat)}	– –	2 3.5	Vdc
Base–Emitter On Voltage (I _C = 3 Adc, V _{CE} = 3 Vdc)	V _{BE(on)}	–	2.5	Vdc
DYNAMIC CHARACTERISTICS				
Small–Signal Current Gain (I _C = 3 Adc, V _{CE} = 4 Vdc, f = 1 MHz)	h _{fe}	4	–	–
Output Capacitance (V _{CB} = 10 Vdc, I _E = 0, f = 0.1 MHz)	MJF127 MJF122 C _{ob}	– –	300 200	pF

3. Pulse Test: Pulse Width ≤ 300 μs, Duty Cycle ≤ 2%.

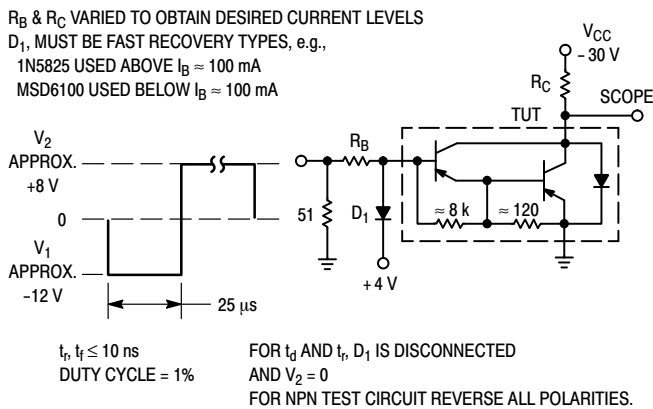

Figure 1. Switching Times Test Circuit

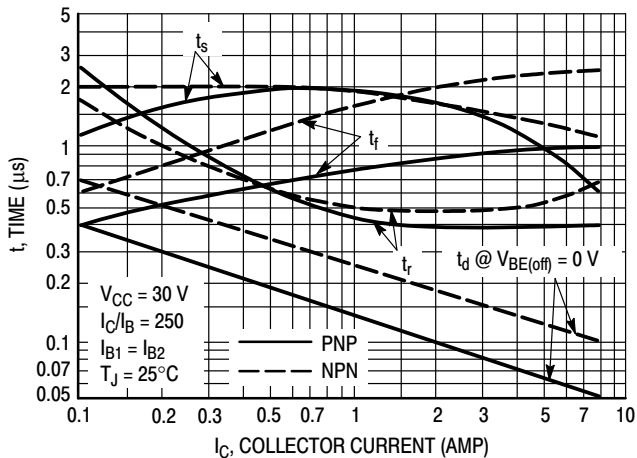

Figure 2. Typical Switching Times

MJF122, MJF127

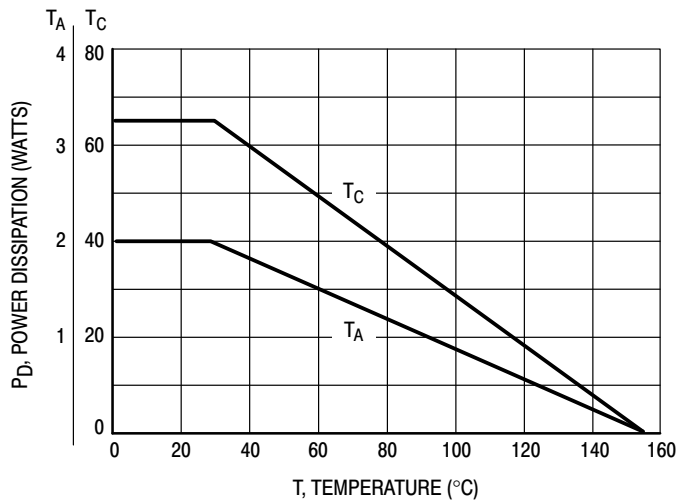

Figure 3. Maximum Power Derating

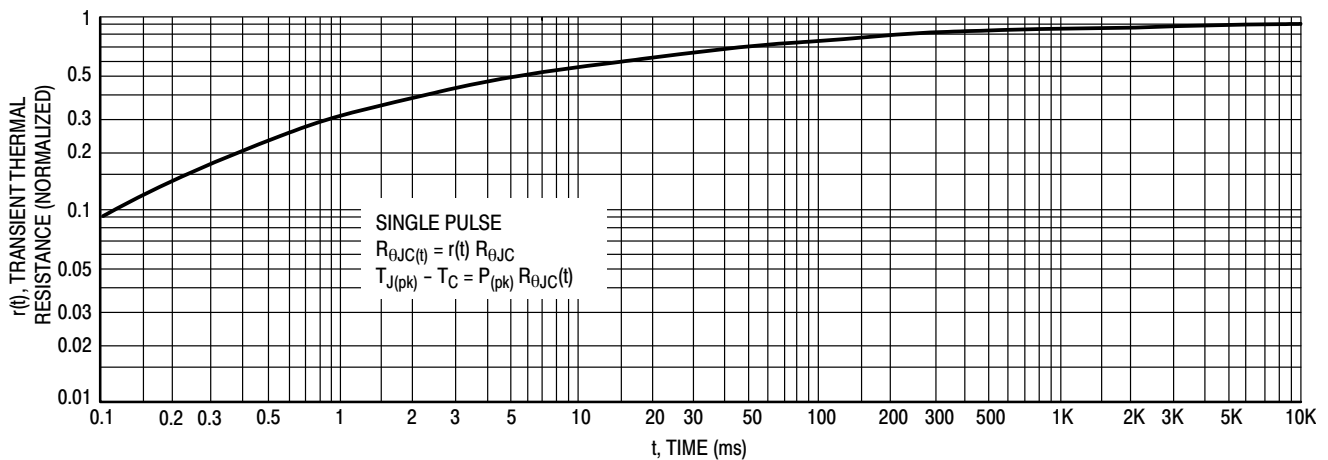

Figure 4. Thermal Response

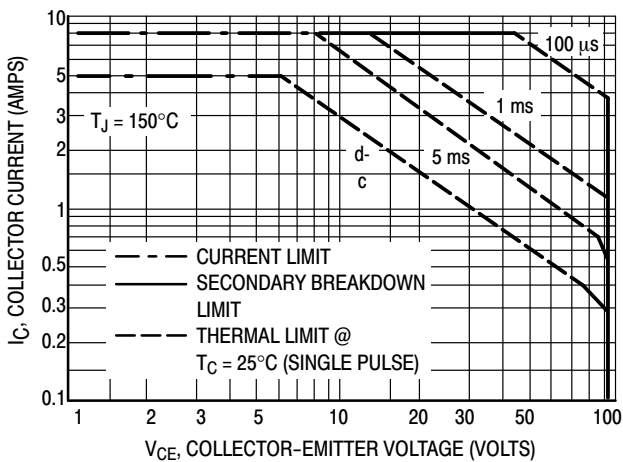

Figure 5. Maximum Forward Bias Safe Operating Area

There are two limitations on the power handling ability of a transistor: average junction temperature and second breakdown. Safe operating area curves indicate $I_C - V_{CE}$ limits of the transistor that must be observed for reliable operation; i.e., the transistor must not be subjected to greater dissipation than the curves indicate.

The data of Figure 5 is based on $T_{J(pk)} = 150^\circ\text{C}$; T_C is variable depending on conditions. Secondary breakdown pulse limits are valid for duty cycles to 10% provided $T_{J(pk)} < 150^\circ\text{C}$. $T_{J(pk)}$ may be calculated from the data in Figure 4. At high case temperatures, thermal limitations will reduce the power that can be handled to values less than the limitations imposed by secondary breakdown.

MJF122, MJF127

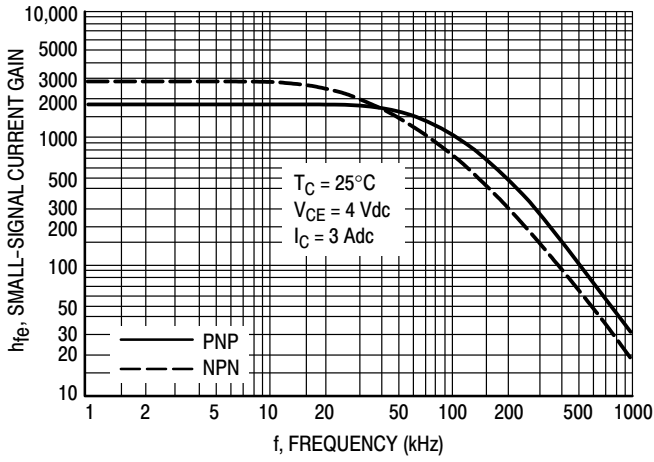

Figure 6. Typical Small-Signal Current Gain

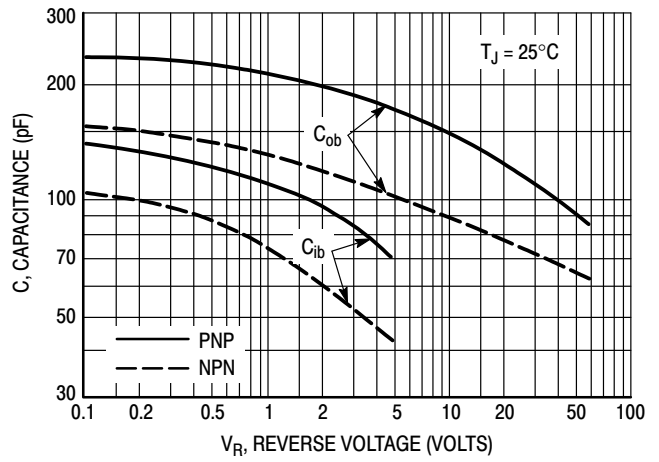

Figure 7. Typical Capacitance

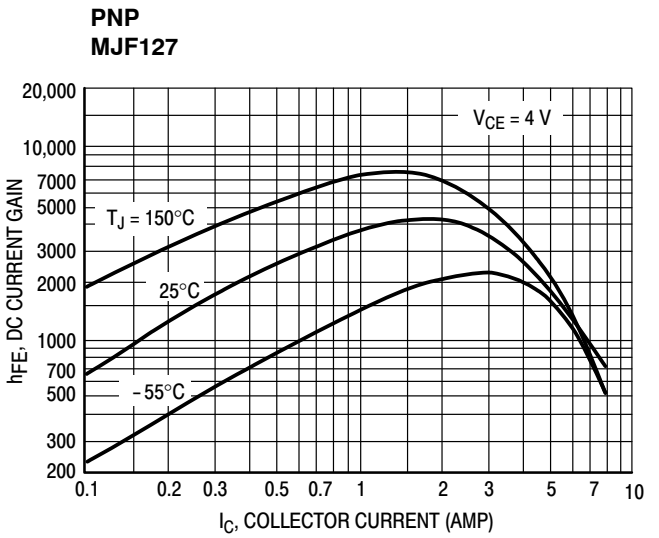
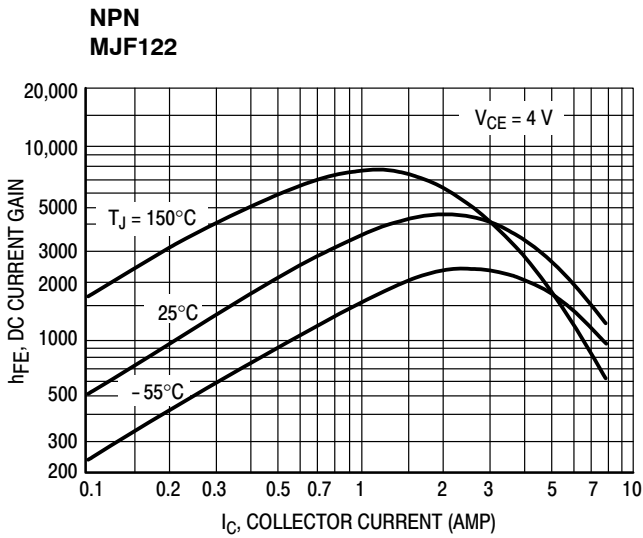

Figure 8. Typical DC Current Gain

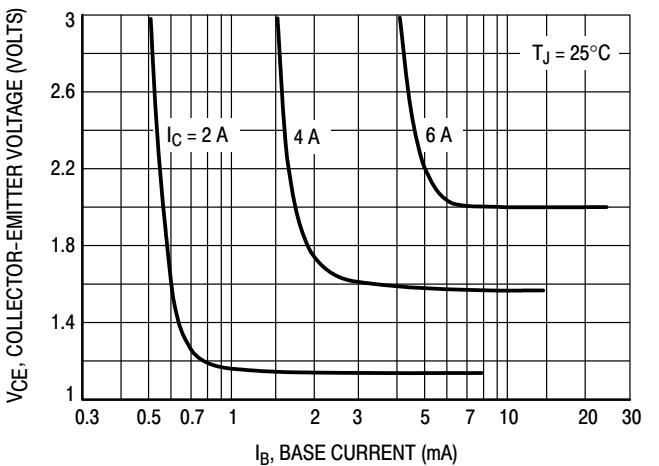
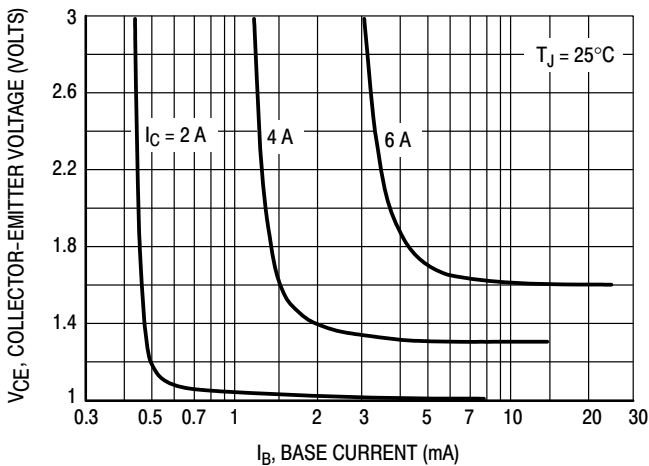
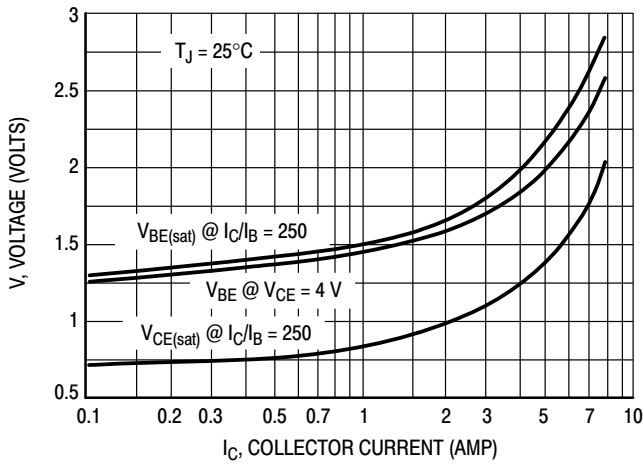

Figure 9. Typical Collector Saturation Region

MJF122, MJF127

**NPN
MJF122**



**PNP
MJF127**

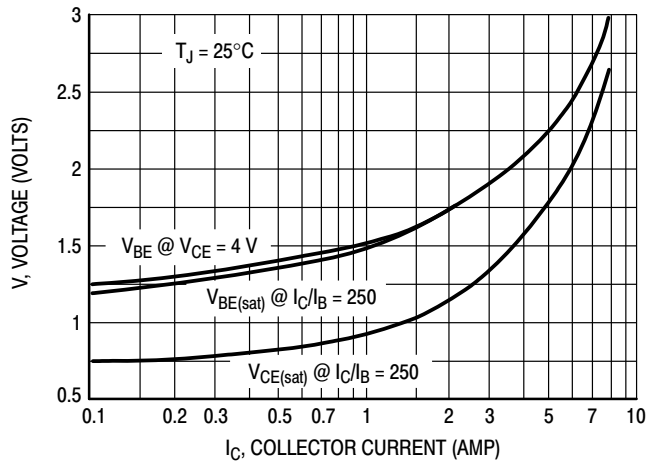

Figure 10. Typical "On" Voltages

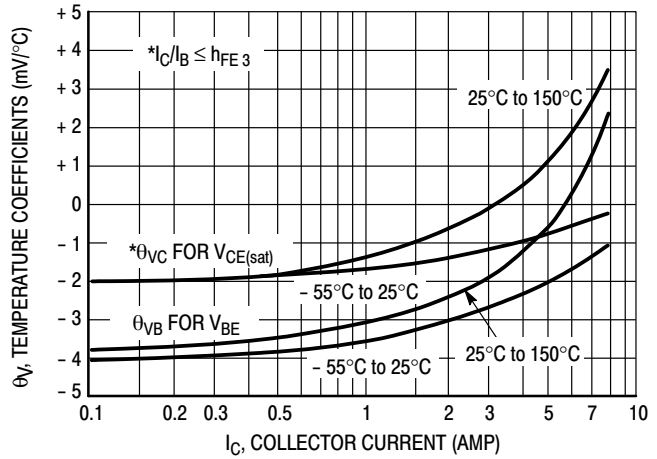
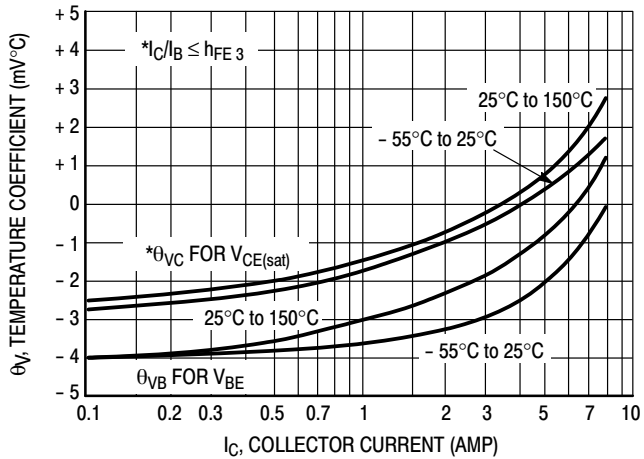

Figure 11. Typical Temperature Coefficients

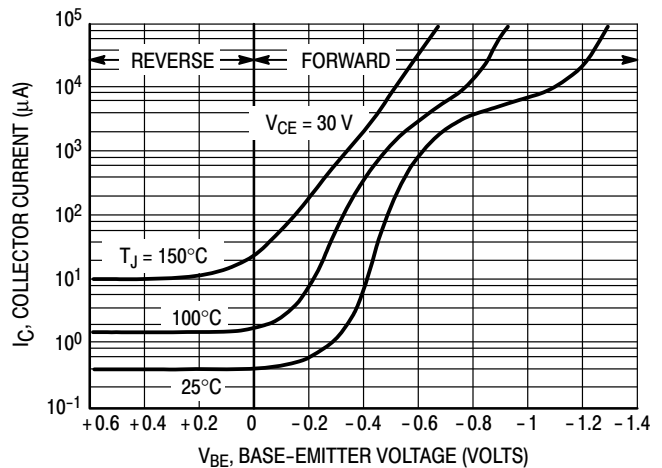
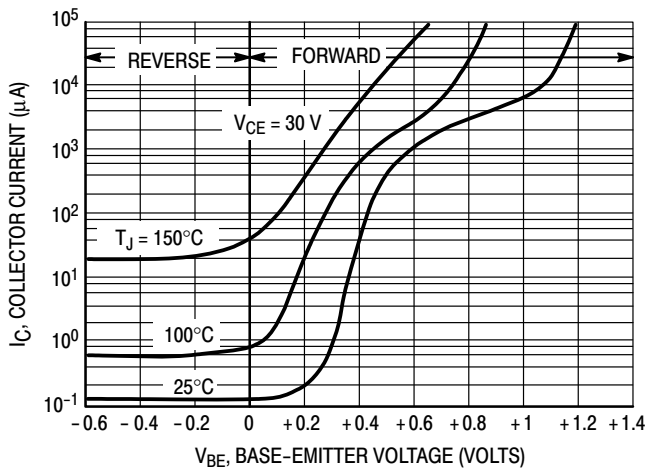
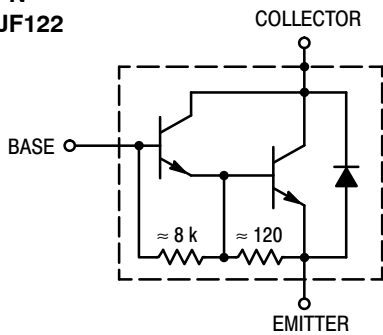

Figure 12. Typical Collector Cut-Off Region

MJF122, MJF127

**NPN
MJF122**



**PNP
MJF127**

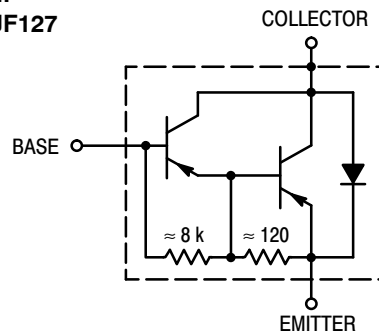

Figure 13. Darlington Schematic

TEST CONDITIONS FOR ISOLATION TESTS*

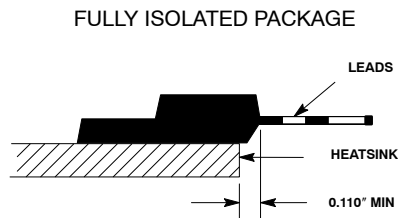

Figure 14. Mounting Position

*Measurement made between leads and heatsink with all leads shorted together.

MOUNTING INFORMATION

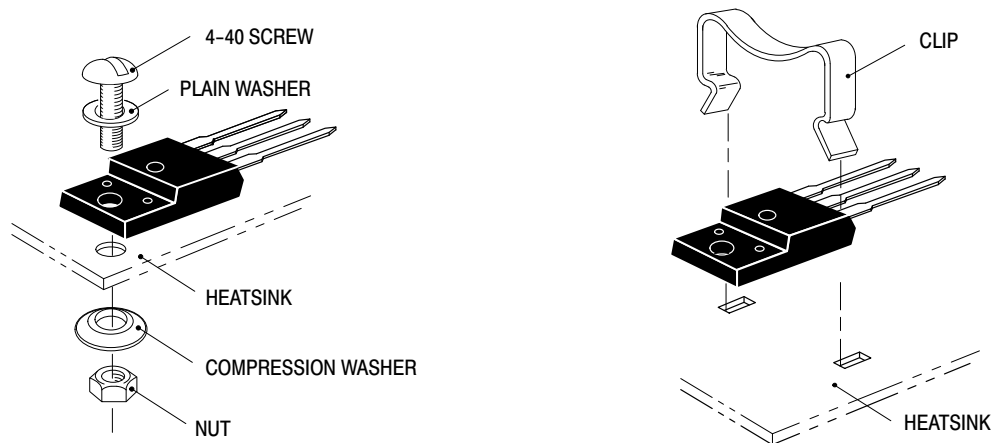

Figure 15. Typical Mounting Techniques*

Laboratory tests on a limited number of samples indicate, when using the screw and compression washer mounting technique, a screw torque of 6 to 8 in · lbs is sufficient to provide maximum power dissipation capability. The compression washer helps to maintain a constant pressure on the package over time and during large temperature excursions.

Destructive laboratory tests show that using a hex head 4-40 screw, without washers, and applying a torque in excess of 20 in · lbs will cause the plastic to crack around the mounting hole, resulting in a loss of isolation capability.

Additional tests on slotted 4-40 screws indicate that the screw slot fails between 15 to 20 in · lbs without adversely affecting the package. However, in order to positively ensure the package integrity of the fully isolated device, ON Semiconductor does not recommend exceeding 10 in · lbs of mounting torque under any mounting conditions.

** For more information about mounting power semiconductors see Application Note AN1040.

MECHANICAL CASE OUTLINE PACKAGE DIMENSIONS

ON Semiconductor®

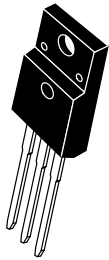

SCALE 1:1

TO-220 FULLPAK CASE 221D-03 ISSUE K

DATE 27 FEB 2009



- NOTES:
- DIMENSIONING AND TOLERANCING PER ANSI Y14.5M, 1982.
 - CONTROLLING DIMENSION: INCH
 - 221D-01 THRU 221D-02 OBSOLETE, NEW STANDARD 221D-03.

DIM	INCHES		MILLIMETERS	
	MIN	MAX	MIN	MAX
A	0.617	0.635	15.67	16.12
B	0.392	0.419	9.96	10.63
C	0.177	0.193	4.50	4.90
D	0.024	0.039	0.60	1.00
F	0.116	0.129	2.95	3.28
G	0.100 BSC		2.54 BSC	
H	0.118	0.135	3.00	3.43
J	0.018	0.025	0.45	0.63
K	0.503	0.541	12.78	13.73
L	0.048	0.058	1.23	1.47
N	0.200 BSC		5.08 BSC	
Q	0.122	0.138	3.10	3.50
R	0.099	0.117	2.51	2.96
S	0.092	0.113	2.34	2.87
U	0.239	0.271	6.06	6.88

⊕ 0.25 (0.010) Ⓜ B Ⓜ Y

- | | | |
|--|---|--|
| STYLE 1:
PIN 1. GATE
2. DRAIN
3. SOURCE | STYLE 2:
PIN 1. BASE
2. COLLECTOR
3. EMITTER | STYLE 3:
PIN 1. ANODE
2. CATHODE
3. ANODE |
| STYLE 4:
PIN 1. CATHODE
2. ANODE
3. CATHODE | STYLE 5:
PIN 1. CATHODE
2. ANODE
3. GATE | STYLE 6:
PIN 1. MT 1
2. MT 2
3. GATE |

MARKING DIAGRAMS



Bipolar

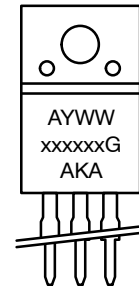

Rectifier

- | | |
|-------------------------------|---------------------------|
| xxxxxx = Specific Device Code | A = Assembly Location |
| G = Pb-Free Package | Y = Year |
| A = Assembly Location | WW = Work Week |
| Y = Year | xxxxxx = Device Code |
| WW = Work Week | G = Pb-Free Package |
| | AKA = Polarity Designator |

DOCUMENT NUMBER:	98ASB42514B	Electronic versions are uncontrolled except when accessed directly from the Document Repository. Printed versions are uncontrolled except when stamped "CONTROLLED COPY" in red.
DESCRIPTION:	TO-220 FULLPAK	PAGE 1 OF 1

ON Semiconductor and are trademarks of Semiconductor Components Industries, LLC dba ON Semiconductor or its subsidiaries in the United States and/or other countries. ON Semiconductor reserves the right to make changes without further notice to any products herein. ON Semiconductor makes no warranty, representation or guarantee regarding the suitability of its products for any particular purpose, nor does ON Semiconductor assume any liability arising out of the application or use of any product or circuit, and specifically disclaims any and all liability, including without limitation special, consequential or incidental damages. ON Semiconductor does not convey any license under its patent rights nor the rights of others.

onsemi, **Onsemi**, and other names, marks, and brands are registered and/or common law trademarks of Semiconductor Components Industries, LLC dba "**onsemi**" or its affiliates and/or subsidiaries in the United States and/or other countries. **onsemi** owns the rights to a number of patents, trademarks, copyrights, trade secrets, and other intellectual property. A listing of **onsemi**'s product/patent coverage may be accessed at www.onsemi.com/site/pdf/Patent-Marking.pdf. **onsemi** reserves the right to make changes at any time to any products or information herein, without notice. The information herein is provided "as-is" and **onsemi** makes no warranty, representation or guarantee regarding the accuracy of the information, product features, availability, functionality, or suitability of its products for any particular purpose, nor does **onsemi** assume any liability arising out of the application or use of any product or circuit, and specifically disclaims any and all liability, including without limitation special, consequential or incidental damages. Buyer is responsible for its products and applications using **onsemi** products, including compliance with all laws, regulations and safety requirements or standards, regardless of any support or applications information provided by **onsemi**. "Typical" parameters which may be provided in **onsemi** data sheets and/or specifications can and do vary in different applications and actual performance may vary over time. All operating parameters, including "Typicals" must be validated for each customer application by customer's technical experts. **onsemi** does not convey any license under any of its intellectual property rights nor the rights of others. **onsemi** products are not designed, intended, or authorized for use as a critical component in life support systems or any FDA Class 3 medical devices or medical devices with a same or similar classification in a foreign jurisdiction or any devices intended for implantation in the human body. Should Buyer purchase or use **onsemi** products for any such unintended or unauthorized application, Buyer shall indemnify and hold **onsemi** and its officers, employees, subsidiaries, affiliates, and distributors harmless against all claims, costs, damages, and expenses, and reasonable attorney fees arising out of, directly or indirectly, any claim of personal injury or death associated with such unintended or unauthorized use, even if such claim alleges that **onsemi** was negligent regarding the design or manufacture of the part. **onsemi** is an Equal Opportunity/Affirmative Action Employer. This literature is subject to all applicable copyright laws and is not for resale in any manner.

PUBLICATION ORDERING INFORMATION

LITERATURE FULFILLMENT:

Email Requests to: orderlit@onsemi.com

onsemi Website: www.onsemi.com

TECHNICAL SUPPORT

North American Technical Support:

Voice Mail: 1 800-282-9855 Toll Free USA/Canada

Phone: 011 421 33 790 2910

Europe, Middle East and Africa Technical Support:

Phone: 00421 33 790 2910

For additional information, please contact your local Sales Representative