



Is Now Part of



ON Semiconductor®

To learn more about ON Semiconductor, please visit our website at
www.onsemi.com

Please note: As part of the Fairchild Semiconductor integration, some of the Fairchild orderable part numbers will need to change in order to meet ON Semiconductor's system requirements. Since the ON Semiconductor product management systems do not have the ability to manage part nomenclature that utilizes an underscore (_), the underscore (_) in the Fairchild part numbers will be changed to a dash (-). This document may contain device numbers with an underscore (_). Please check the ON Semiconductor website to verify the updated device numbers. The most current and up-to-date ordering information can be found at www.onsemi.com. Please email any questions regarding the system integration to Fairchild_questions@onsemi.com.

ON Semiconductor and the ON Semiconductor logo are trademarks of Semiconductor Components Industries, LLC dba ON Semiconductor or its subsidiaries in the United States and/or other countries. ON Semiconductor owns the rights to a number of patents, trademarks, copyrights, trade secrets, and other intellectual property. A listing of ON Semiconductor's product/patent coverage may be accessed at www.onsemi.com/site/pdf/Patent-Marking.pdf. ON Semiconductor reserves the right to make changes without further notice to any products herein. ON Semiconductor makes no warranty, representation or guarantee regarding the suitability of its products for any particular purpose, nor does ON Semiconductor assume any liability arising out of the application or use of any product or circuit, and specifically disclaims any and all liability, including without limitation special, consequential or incidental damages. Buyer is responsible for its products and applications using ON Semiconductor products, including compliance with all laws, regulations and safety requirements or standards, regardless of any support or applications information provided by ON Semiconductor. "Typical" parameters which may be provided in ON Semiconductor data sheets and/or specifications can and do vary in different applications and actual performance may vary over time. All operating parameters, including "Typicals" must be validated for each customer application by customer's technical experts. ON Semiconductor does not convey any license under its patent rights nor the rights of others. ON Semiconductor products are not designed, intended, or authorized for use as a critical component in life support systems or any FDA Class 3 medical devices or medical devices with a same or similar classification in a foreign jurisdiction or any devices intended for implantation in the human body. Should Buyer purchase or use ON Semiconductor products for any such unintended or unauthorized application, Buyer shall indemnify and hold ON Semiconductor and its officers, employees, subsidiaries, affiliates, and distributors harmless against all claims, costs, damages, and expenses, and reasonable attorney fees arising out of, directly or indirectly, any claim of personal injury or death associated with such unintended or unauthorized use, even if such claim alleges that ON Semiconductor was negligent regarding the design or manufacture of the part. ON Semiconductor is an Equal Opportunity/Affirmative Action Employer. This literature is subject to all applicable copyright laws and is not for resale in any manner.

Low Frequency Amplifier & Medium Speed Switching

- Complement to KSC1008
- Collector-Base Voltage : $V_{CBO} = -80V$
- Collector Power Dissipation : $P_C = 800mW$
- Suffix “-C” means Center Collector (1. Emitter 2. Collector 3. Base)

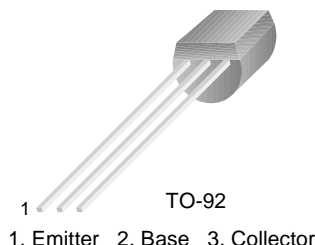

PNP Epitaxial Silicon Transistor

Absolute Maximum Ratings $T_a = 25^\circ C$ unless otherwise noted

| Symbol | Parameter | Ratings | Units |
|-----------|-----------------------------|-----------|------------|
| V_{CBO} | Collector-Base Voltage | -80 | V |
| V_{CEO} | Collector-Emitter Voltage | -60 | V |
| V_{EBO} | Emitter-Base Voltage | -8 | V |
| I_C | Collector Current | -700 | mA |
| P_C | Collector Power Dissipation | 800 | mW |
| T_J | Junction Temperature | 150 | $^\circ C$ |
| T_{STG} | Storage Temperature | -55 ~ 150 | $^\circ C$ |

Electrical Characteristics $T_a = 25^\circ C$ unless otherwise noted

| Symbol | Parameter | Test Condition | Min. | Typ. | Max. | Units |
|---------------|--|------------------------------------|------|------|------|---------|
| BV_{CBO} | Collector-Base Breakdown Voltage | $I_C = -100\mu A, I_E = 0$ | -80 | | | V |
| BV_{CEO} | Collector-Emitter Breakdown Voltage | $I_C = -10mA, I_B = 0$ | -60 | | | V |
| BV_{EBO} | Emitter-Base Breakdown Voltage | $I_E = -100\mu A, I_C = 0$ | -8 | | | V |
| I_{CBO} | Collector Cut-off Current | $V_{CB} = -60V, I_E = 0$ | | | -0.1 | μA |
| I_{EBO} | Emitter Cut-off Current | $V_{EB} = -5V, I_C = 0$ | | | -0.1 | μA |
| h_{FE} | * DC Current Gain | $V_{CE} = -2V, I_C = -50mA$ | 40 | | 240 | |
| $V_{CE(sat)}$ | * Collector-Emitter Saturation Voltage | $I_C = -500mA, I_B = -50mA$ | | -0.3 | -0.7 | V |
| $V_{BE(sat)}$ | * Base-Emitter Saturation Voltage | $I_C = -500mA, I_B = -50mA$ | | -0.9 | 1.1 | V |
| f_T | Current Gain Bandwidth Product | $V_{CE} = -10V, I_C = -50mA$ | | 50 | | MHz |
| C_{ob} | Output Capacitance | $V_{CB} = -10V, I_E = 0, f = 1MHz$ | | 13 | | pF |

* Pulse Test: $PW \leq 350\mu s$, Duty cycle $\leq 2\%$

h_{FE} Classification

| Classification | R | O | Y |
|----------------|---------|----------|-----------|
| h_{FE} | 40 ~ 80 | 70 ~ 140 | 120 ~ 240 |

Typical Characteristics

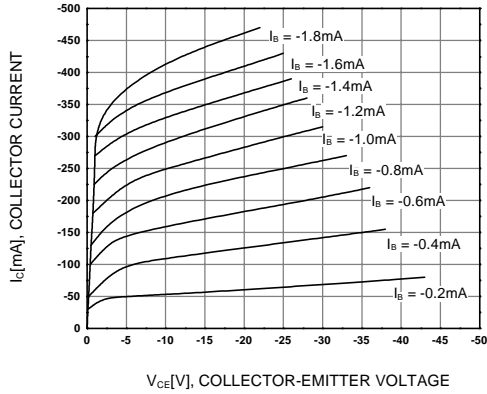

Figure 1. Static Characteristic

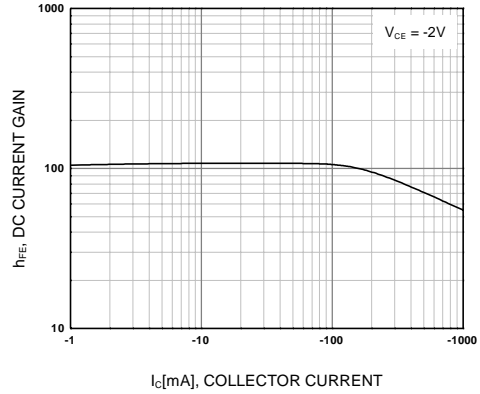

Figure 2. DC current Gain

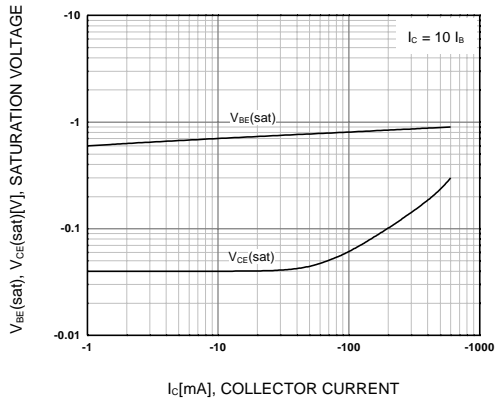

Figure 3. Base-Emitter Saturation Voltage
Collector-Emitter Saturation Voltage

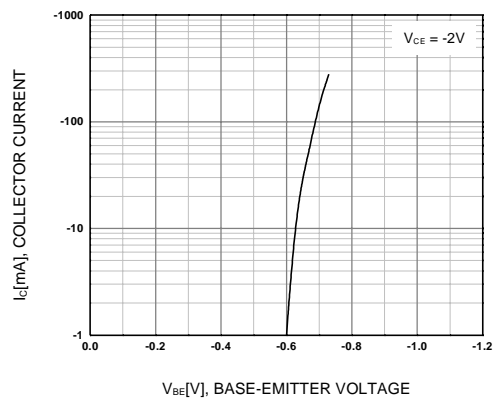

Figure 4. Base-Emitter On Voltage

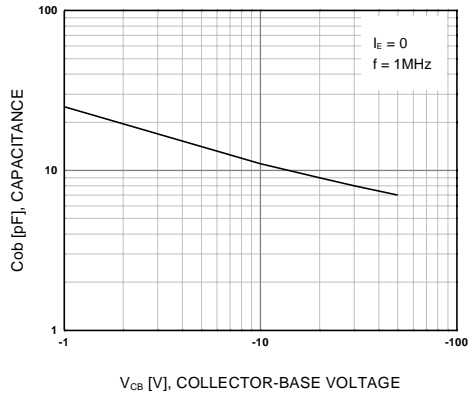
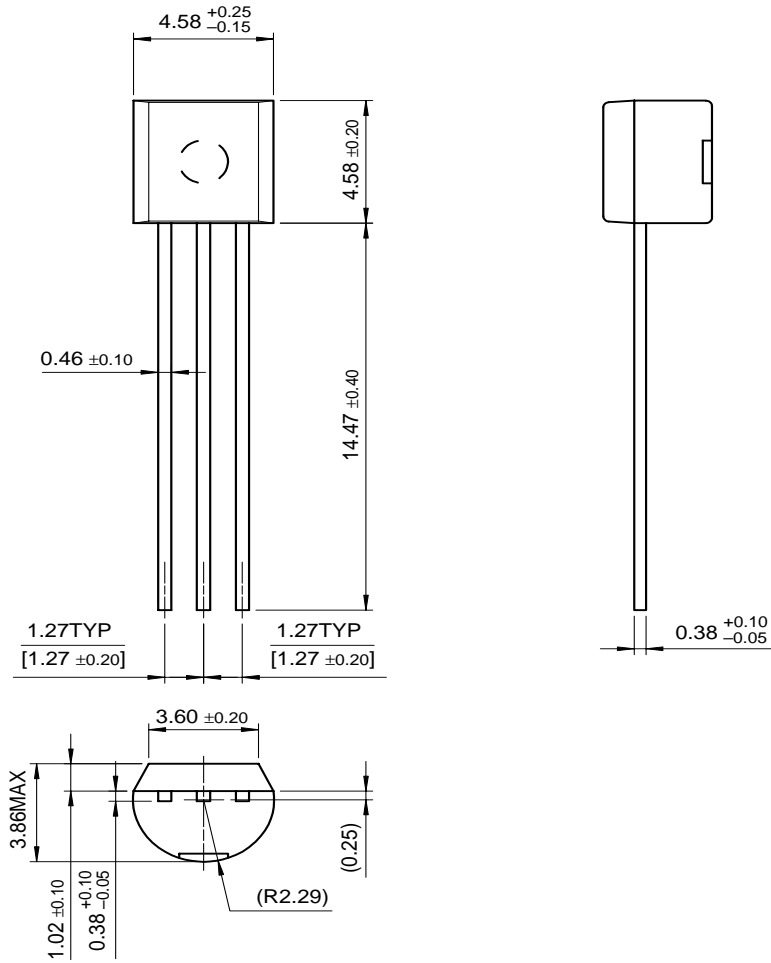

Figure 5. Collector Output Capacitance

Package Dimensions

KSA708

TO-92



Dimensions in Millimeters

TRADEMARKS

The following are registered and unregistered trademarks Fairchild Semiconductor owns or is authorized to use and is not intended to be an exhaustive list of all such trademarks.

| | | | | |
|-----------------------------------|----------------------------------|----------------------------------|------------------------------|-------------------|
| ACE _x TM | FAST [®] | OPTOLOGIC TM | SMART START TM | VCX TM |
| Bottomless TM | FAST _r TM | OPTOPLANAR TM | STAR*POWER TM | |
| CoolFET TM | FRFET TM | PACMAN TM | Stealth TM | |
| CROSSVOLT TM | GlobalOptoisolator TM | POP TM | SuperSOT TM -3 | |
| DenseTrench TM | GTO TM | Power247 TM | SuperSOT TM -6 | |
| DOMET TM | HiSeC TM | PowerTrench [®] | SuperSOT TM -8 | |
| EcoSPARK TM | ISOPLANAR TM | QFET TM | SyncFET TM | |
| E ² CMOS TM | LittleFET TM | QS TM | TruTranslation TM | |
| EnSigna TM | MicroFET TM | QT Optoelectronics TM | TinyLogic TM | |
| FACT TM | MicroPak TM | Quiet Series TM | UHC TM | |
| FACT Quiet Series TM | MICROWIRE TM | SLIENT SWITCHER [®] | UltraFET [®] | |

STAR*POWER is used under license

DISCLAIMER

FAIRCHILD SEMICONDUCTOR RESERVES THE RIGHT TO MAKE CHANGES WITHOUT FURTHER NOTICE TO ANY PRODUCTS HEREIN TO IMPROVE RELIABILITY, FUNCTION OR DESIGN. FAIRCHILD DOES NOT ASSUME ANY LIABILITY ARISING OUT OF THE APPLICATION OR USE OF ANY PRODUCT OR CIRCUIT DESCRIBED HEREIN; NEITHER DOES IT CONVEY ANY LICENSE UNDER ITS PATENT RIGHTS, NOR THE RIGHTS OF OTHERS.

LIFE SUPPORT POLICY

FAIRCHILD'S PRODUCTS ARE NOT AUTHORIZED FOR USE AS CRITICAL COMPONENTS IN LIFE SUPPORT DEVICES OR SYSTEMS WITHOUT THE EXPRESS WRITTEN APPROVAL OF FAIRCHILD SEMICONDUCTOR CORPORATION.

As used herein:

1. Life support devices or systems are devices or systems which, (a) are intended for surgical implant into the body, or (b) support or sustain life, or (c) whose failure to perform when properly used in accordance with instructions for use provided in the labeling, can be reasonably expected to result in significant injury to the user.
2. A critical component is any component of a life support device or system whose failure to perform can be reasonably expected to cause the failure of the life support device or system, or to affect its safety or effectiveness.

PRODUCT STATUS DEFINITIONS

Definition of Terms

| Datasheet Identification | Product Status | Definition |
|--------------------------|------------------------|---|
| Advance Information | Formative or In Design | This datasheet contains the design specifications for product development. Specifications may change in any manner without notice. |
| Preliminary | First Production | This datasheet contains preliminary data, and supplementary data will be published at a later date. Fairchild Semiconductor reserves the right to make changes at any time without notice in order to improve design. |
| No Identification Needed | Full Production | This datasheet contains final specifications. Fairchild Semiconductor reserves the right to make changes at any time without notice in order to improve design. |
| Obsolete | Not In Production | This datasheet contains specifications on a product that has been discontinued by Fairchild semiconductor. The datasheet is printed for reference information only. |

ON Semiconductor and  are trademarks of Semiconductor Components Industries, LLC dba ON Semiconductor or its subsidiaries in the United States and/or other countries. ON Semiconductor owns the rights to a number of patents, trademarks, copyrights, trade secrets, and other intellectual property. A listing of ON Semiconductor's product/patent coverage may be accessed at www.onsemi.com/site/pdf/Patent-Marking.pdf. ON Semiconductor reserves the right to make changes without further notice to any products herein. ON Semiconductor makes no warranty, representation or guarantee regarding the suitability of its products for any particular purpose, nor does ON Semiconductor assume any liability arising out of the application or use of any product or circuit, and specifically disclaims any and all liability, including without limitation special, consequential or incidental damages. Buyer is responsible for its products and applications using ON Semiconductor products, including compliance with all laws, regulations and safety requirements or standards, regardless of any support or applications information provided by ON Semiconductor. "Typical" parameters which may be provided in ON Semiconductor data sheets and/or specifications can and do vary in different applications and actual performance may vary over time. All operating parameters, including "Typicals" must be validated for each customer application by customer's technical experts. ON Semiconductor does not convey any license under its patent rights nor the rights of others. ON Semiconductor products are not designed, intended, or authorized for use as a critical component in life support systems or any FDA Class 3 medical devices or medical devices with a same or similar classification in a foreign jurisdiction or any devices intended for implantation in the human body. Should Buyer purchase or use ON Semiconductor products for any such unintended or unauthorized application, Buyer shall indemnify and hold ON Semiconductor and its officers, employees, subsidiaries, affiliates, and distributors harmless against all claims, costs, damages, and expenses, and reasonable attorney fees arising out of, directly or indirectly, any claim of personal injury or death associated with such unintended or unauthorized use, even if such claim alleges that ON Semiconductor was negligent regarding the design or manufacture of the part. ON Semiconductor is an Equal Opportunity/Affirmative Action Employer. This literature is subject to all applicable copyright laws and is not for resale in any manner.

PUBLICATION ORDERING INFORMATION

LITERATURE FULFILLMENT:

Literature Distribution Center for ON Semiconductor
19521 E. 32nd Pkwy, Aurora, Colorado 80011 USA
Phone: 303-675-2175 or 800-344-3860 Toll Free USA/Canada
Fax: 303-675-2176 or 800-344-3867 Toll Free USA/Canada
Email: orderlit@onsemi.com

N. American Technical Support: 800-282-9855 Toll Free
USA/Canada
Europe, Middle East and Africa Technical Support:
Phone: 421 33 790 2910
Japan Customer Focus Center
Phone: 81-3-5817-1050

ON Semiconductor Website: www.onsemi.com
Order Literature: <http://www.onsemi.com/orderlit>
For additional information, please contact your local
Sales Representative