

NDF11N50Z

N-Channel Power MOSFET 500 V, 0.52 Ω

Features

- Low ON Resistance
- Low Gate Charge
- ESD Diode–Protected Gate
- 100% Avalanche Tested
- These Devices are Pb–Free, Halogen Free/BFR Free and are RoHS Compliant

ABSOLUTE MAXIMUM RATINGS ($T_C = 25^\circ\text{C}$ unless otherwise noted)

Rating	Symbol	NDF	Unit
Drain–to–Source Voltage	V_{DSS}	500	V
Continuous Drain Current, $R_{\theta JC}$ (Note 1)	I_D	12	A
Continuous Drain Current $T_A = 100^\circ\text{C}$, $R_{\theta JC}$ (Note 1)	I_D	7.4	A
Pulsed Drain Current, $t_P = 10 \mu\text{s}$	I_{DM}	44	A
Power Dissipation, $R_{\theta JC}$	P_D	39	W
Gate–to–Source Voltage	V_{GS}	± 30	V
Single Pulse Avalanche Energy, $I_D = 10 \text{ A}$	E_{AS}	420	mJ
ESD (HBM) (JESD22–A114)	V_{esd}	4000	V
RMS Isolation Voltage ($t = 0.3 \text{ sec.}$, R.H. $\leq 30\%$, $T_A = 25^\circ\text{C}$) (Figure 14)	V_{ISO}	4500	V
Peak Diode Recovery (Note 2)	dv/dt	4.5	V/ns
MOSFET dV/dt	dV/dt	60	V/ns
Continuous Source Current (Body Diode)	I_S	12	A
Maximum Temperature for Soldering Leads	T_L	260	$^\circ\text{C}$
Operating Junction and Storage Temperature Range	T_J, T_{stg}	-55 to 150	$^\circ\text{C}$

Stresses exceeding those listed in the Maximum Ratings table may damage the device. If any of these limits are exceeded, device functionality should not be assumed, damage may occur and reliability may be affected.

1. Limited by maximum junction temperature
2. $I_d \leq 10.5 \text{ A}$, $di/dt \leq 200 \text{ A}/\mu\text{s}$, $V_{DD} \leq BV_{DSS}$, $T_J \leq 150^\circ\text{C}$.



ON Semiconductor®

www.onsemi.com

V_{DSS}	$R_{DS(ON)} \text{ (MAX) @ } 4.5 \text{ A}$
500 V	0.52 Ω

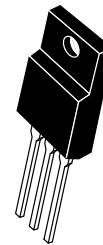
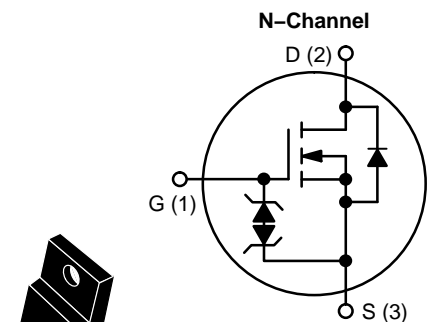

NDF11N50ZG
NDF11N50ZH
TO–220FP
CASE 221AH

MARKING DIAGRAM

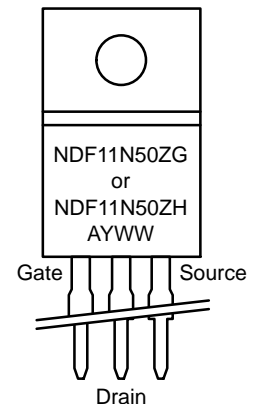

- A = Location Code
- Y = Year
- WW = Work Week
- G, H = Pb–Free, Halogen–Free Package

ORDERING INFORMATION

See detailed ordering and shipping information on page 6 of this data sheet.

NDF11N50Z

THERMAL RESISTANCE

Parameter	Symbol	NDF11N50Z	Unit
Junction-to-Case (Drain)	$R_{\theta JC}$	3.2	°C/W
Junction-to-Ambient Steady State (Note 3)	$R_{\theta JA}$	50	

ELECTRICAL CHARACTERISTICS ($T_J = 25^\circ\text{C}$ unless otherwise noted)

Characteristic	Test Conditions	Symbol	Min	Typ	Max	Unit
----------------	-----------------	--------	-----	-----	-----	------

OFF CHARACTERISTICS

Drain-to-Source Breakdown Voltage	$V_{GS} = 0\text{ V}, I_D = 1\text{ mA}$	BV_{DSS}	500			V
Breakdown Voltage Temperature Coefficient	Reference to 25°C , $I_D = 1\text{ mA}$	$\Delta BV_{DSS}/\Delta T_J$		0.6		V/°C
Drain-to-Source Leakage Current	$V_{DS} = 500\text{ V}, V_{GS} = 0\text{ V}$	I_{DSS}	25°C		1	μA
			125°C		50	
Gate-to-Source Forward Leakage	$V_{GS} = \pm 20\text{ V}$	I_{GSS}			±10	μA

ON CHARACTERISTICS (Note 4)

Static Drain-to-Source On-Resistance	$V_{GS} = 10\text{ V}, I_D = 4.5\text{ A}$	$R_{DS(on)}$		0.48	0.52	Ω
Gate Threshold Voltage	$V_{DS} = V_{GS}, I_D = 100\text{ }\mu\text{A}$	$V_{GS(th)}$	3.0	3.9	4.5	V
Forward Transconductance	$V_{DS} = 15\text{ V}, I_D = 4.5\text{ A}$	g_{FS}		7.7		S

DYNAMIC CHARACTERISTICS

Input Capacitance (Note 5)	$V_{DS} = 25\text{ V}, V_{GS} = 0\text{ V},$ $f = 1.0\text{ MHz}$	C_{iss}	1097	1375	1645	pF
Output Capacitance (Note 5)		C_{oss}	132	166	199	
Reverse Transfer Capacitance (Note 5)		C_{rss}	30	40	50	
Total Gate Charge (Note 5)	$V_{DD} = 250\text{ V}, I_D = 10.5\text{ A},$ $V_{GS} = 10\text{ V}$	Q_g	23	46	69	nC
Gate-to-Source Charge (Note 5)		Q_{gs}	4.5	8.7	13	
Gate-to-Drain ("Miller") Charge (Note 5)		Q_{gd}	12.5	25	37.5	
Plateau Voltage		V_{GP}		6.2		V
Gate Resistance		R_g		1.4		Ω

RESISTIVE SWITCHING CHARACTERISTICS

Turn-On Delay Time	$V_{DD} = 250\text{ V}, I_D = 10.5\text{ A},$ $V_{GS} = 10\text{ V}, R_G = 5\text{ }\Omega$	$t_{d(on)}$		15		ns
Rise Time		t_r		32		
Turn-Off Delay Time		$t_{d(off)}$		40		
Fall Time		t_f		23		

SOURCE-DRAIN DIODE CHARACTERISTICS ($T_C = 25^\circ\text{C}$ unless otherwise noted)

Diode Forward Voltage	$I_S = 10.5\text{ A}, V_{GS} = 0\text{ V}$	V_{SD}			1.6	V
Reverse Recovery Time	$V_{GS} = 0\text{ V}, V_{DD} = 30\text{ V}$ $I_S = 10.5\text{ A}, di/dt = 100\text{ A}/\mu\text{s}$	t_{rr}		310		ns
Reverse Recovery Charge		Q_{rr}		2.5		μC

Product parametric performance is indicated in the Electrical Characteristics for the listed test conditions, unless otherwise noted. Product performance may not be indicated by the Electrical Characteristics if operated under different conditions.

3. Insertion mounted
4. Pulse Width $\leq 380\text{ }\mu\text{s}$, Duty Cycle $\leq 2\%$.
5. Guaranteed by design.

NDF11N50Z

TYPICAL CHARACTERISTICS

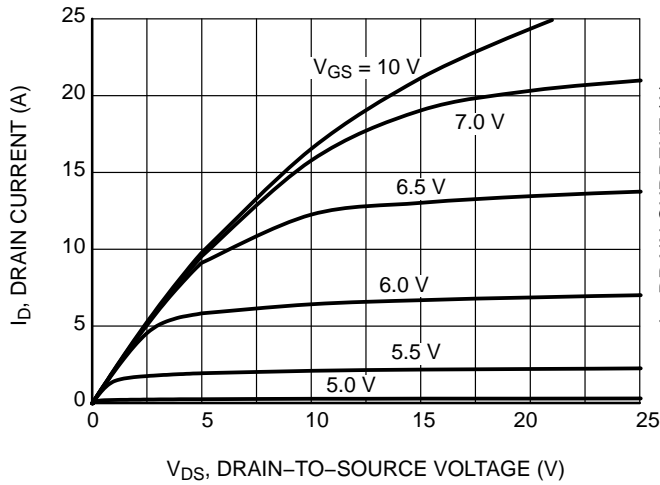

Figure 1. On-Region Characteristics

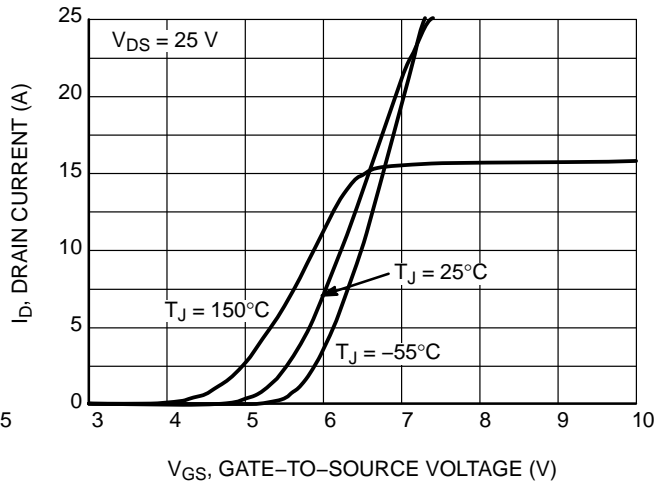

Figure 2. Transfer Characteristics

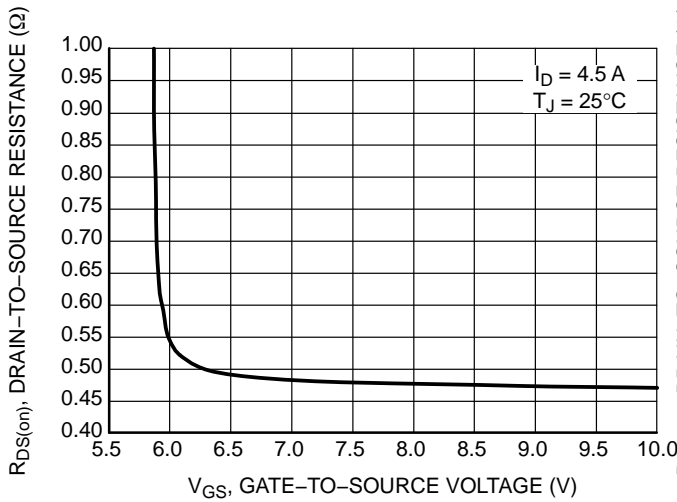

Figure 3. On-Region versus Gate-to-Source Voltage

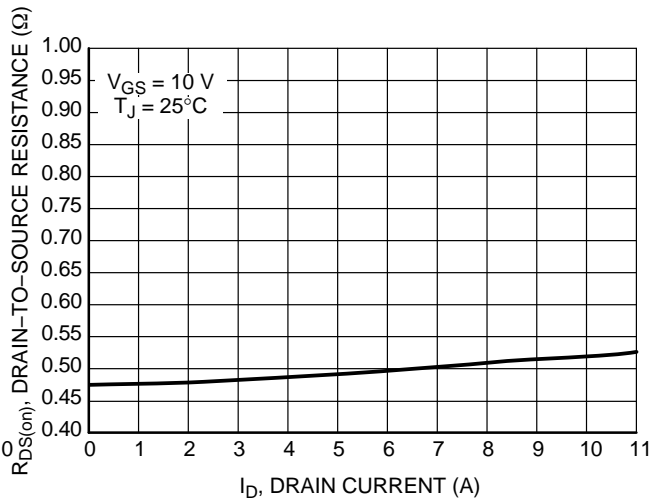

Figure 4. On-Resistance versus Drain Current and Gate Voltage

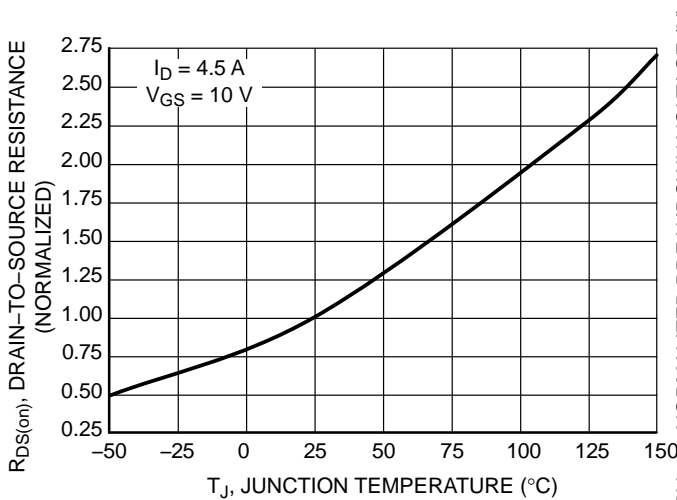

Figure 5. On-Resistance Variation with Temperature

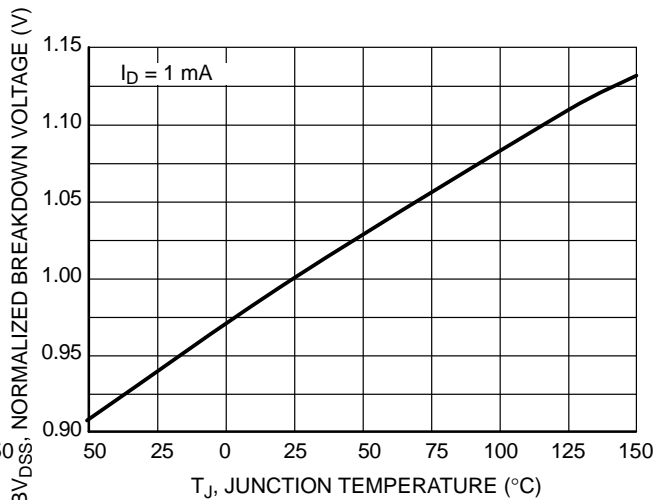

Figure 6. BV_{DSS} Variation with Temperature

NDF11N50Z

TYPICAL CHARACTERISTICS

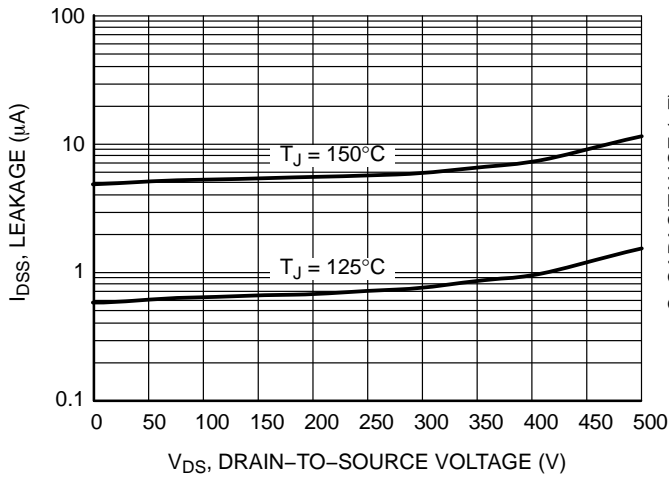

Figure 7. Drain-to-Source Leakage Current versus Voltage

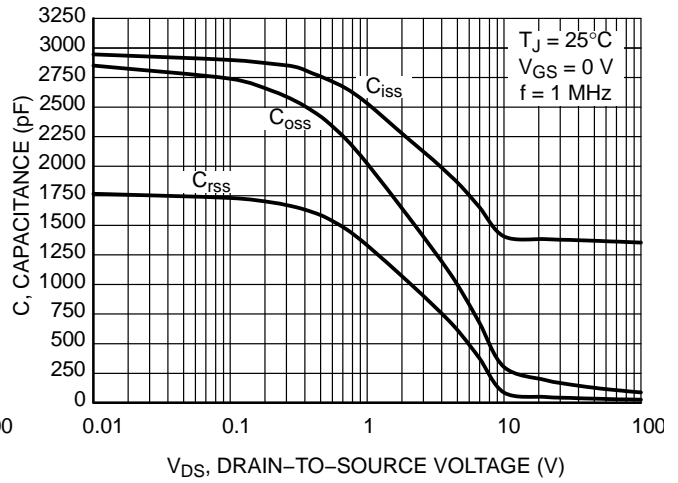

Figure 8. Capacitance Variation

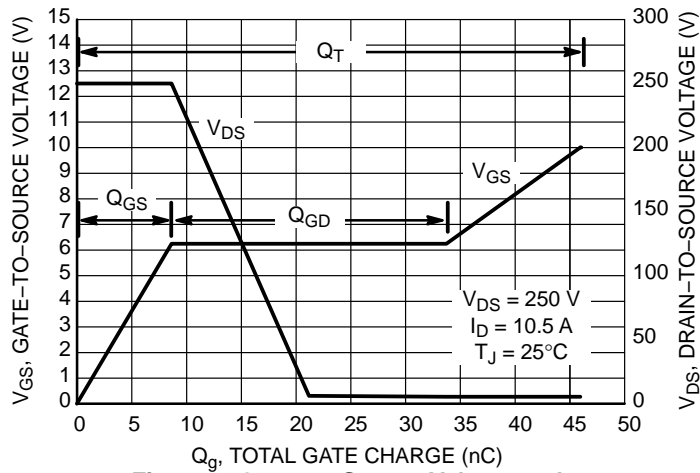

Figure 9. Gate-to-Source Voltage and Drain-to-Source Voltage versus Total Charge

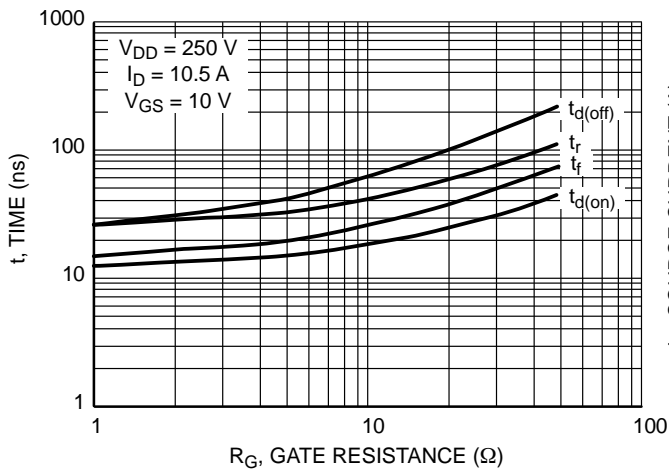

Figure 10. Resistive Switching Time Variation versus Gate Resistance

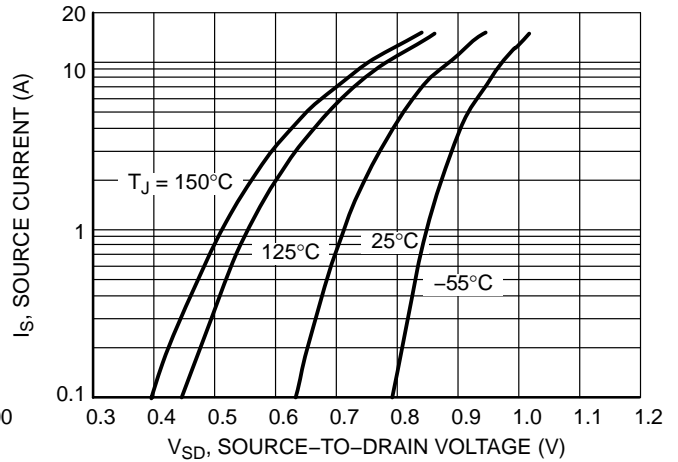

Figure 11. Diode Forward Voltage versus Current

NDF11N50Z

TYPICAL CHARACTERISTICS

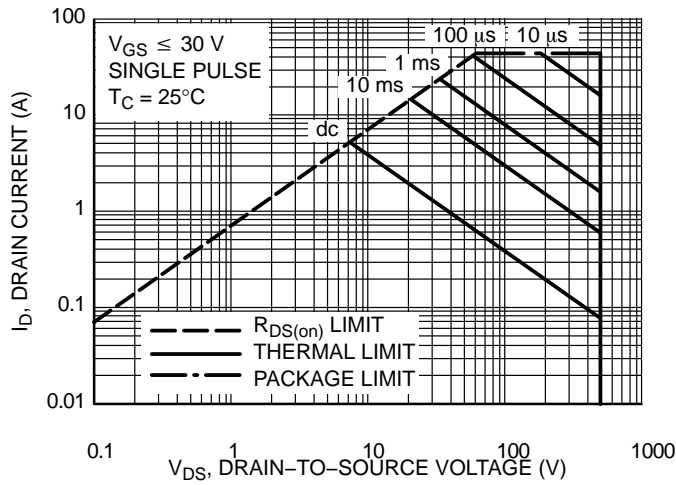

Figure 12. Maximum Rated Forward Biased Safe Operating Area NDF11N50Z

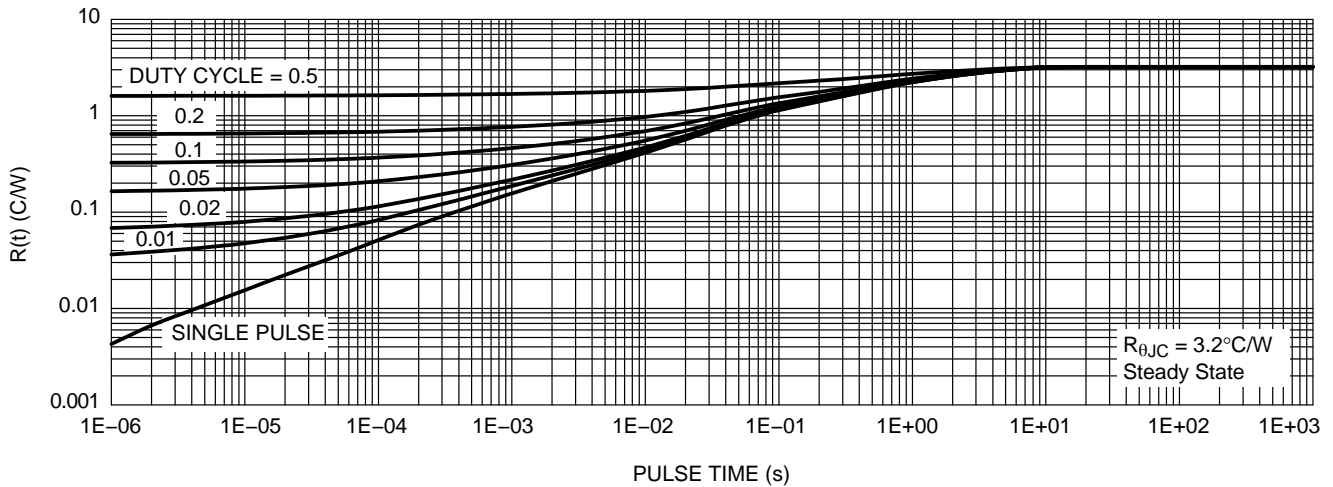

Figure 13. Thermal Impedance (Junction-to-Case) for NDF11N50Z

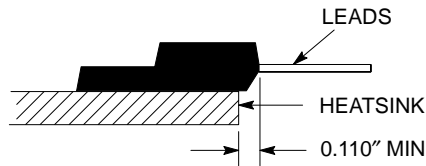

Figure 14. Isolation Test Diagram

Measurement made between leads and heatsink with all leads shorted together.

*For additional mounting information, please download the ON Semiconductor Soldering and Mounting Techniques Reference Manual, SOLDERRM/D.

NDF11N50Z

ORDERING INFORMATION

Order Number	Package	Shipping
NDF11N50ZG	TO-220FP (Pb-Free, Halogen-Free)	50 Units / Rail
NDF11N50ZH	TO-220FP (Pb-Free, Halogen-Free)	50 Units / Rail

MECHANICAL CASE OUTLINE

PACKAGE DIMENSIONS

ON Semiconductor®



TO-220 FULLPACK, 3-LEAD CASE 221AH ISSUE F

DATE 30 SEP 2014

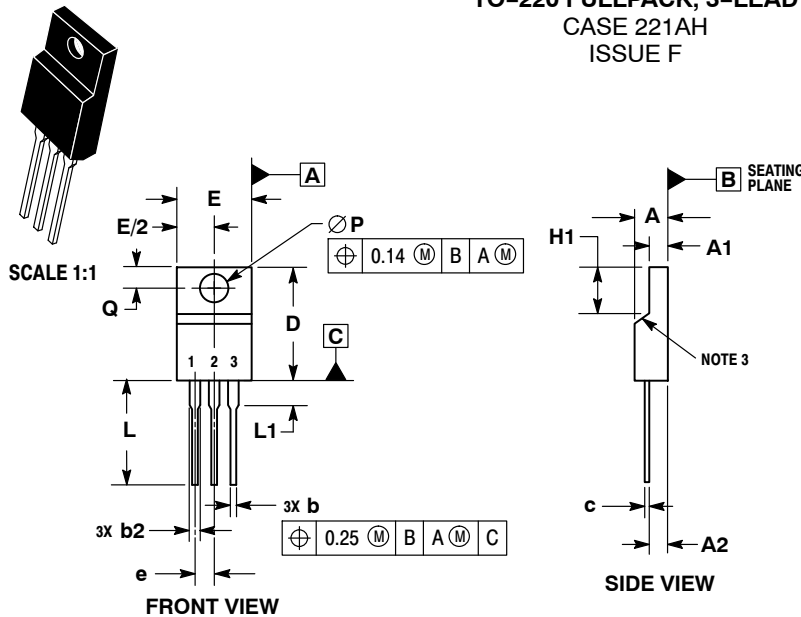

NOTES:

1. DIMENSIONING AND TOLERANCING PER ASME Y14.5M, 1994.
2. CONTROLLING DIMENSION: MILLIMETERS.
3. CONTOUR UNCONTROLLED IN THIS AREA.
4. DIMENSIONS D AND E DO NOT INCLUDE MOLD FLASH AND GATE PROTRUSIONS. MOLD FLASH AND GATE PROTRUSIONS NOT TO EXCEED 0.13 PER SIDE. THESE DIMENSIONS ARE TO BE MEASURED AT OUTERMOST EXTREME OF THE PLASTIC BODY.
5. DIMENSION b2 DOES NOT INCLUDE DAMBAR PROTRUSION. LEAD WIDTH INCLUDING PROTRUSION SHALL NOT EXCEED 2.00.
6. CONTOURS AND FEATURES OF THE MOLDED PACKAGE BODY MAY VARY WITHIN THE ENVELOPE DEFINED BY DIMENSIONS A1 AND H1 FOR MANUFACTURING PURPOSES.

DIM	MILLIMETERS	
	MIN	MAX
A	4.30	4.70
A1	2.50	2.90
A2	2.50	2.90
b	0.54	0.84
b2	1.10	1.40
c	0.49	0.79
D	14.70	15.30
E	9.70	10.30
e	2.54 BSC	
H1	6.60	7.10
L	12.50	14.73
L1	---	2.80
P	3.00	3.40
Q	2.80	3.20

GENERIC MARKING DIAGRAM*

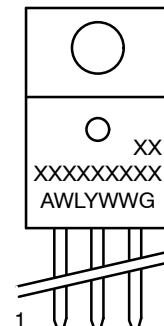

- A = Assembly Location
- WL = Wafer Lot
- Y = Year
- WW = Work Week
- G = Pb-Free Package

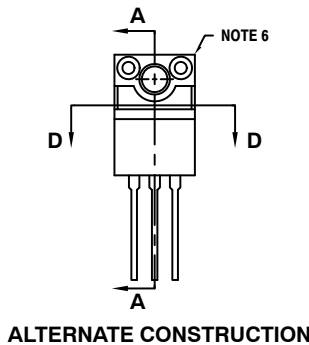

STYLE 1:

1. MAIN TERMINAL 1
2. MAIN TERMINAL 2
3. GATE

STYLE 2:

1. CATHODE
2. ANODE
3. GATE

*This information is generic. Please refer to device data sheet for actual part marking. Pb-Free indicator, "G" or microdot "▪", may or may not be present.

DOCUMENT NUMBER:	98AON52577E	Electronic versions are uncontrolled except when accessed directly from the Document Repository. Printed versions are uncontrolled except when stamped "CONTROLLED COPY" in red.
DESCRIPTION:	TO-220 FULLPACK, 3-LEAD	PAGE 1 OF 1

ON Semiconductor and ON are trademarks of Semiconductor Components Industries, LLC dba ON Semiconductor or its subsidiaries in the United States and/or other countries. ON Semiconductor reserves the right to make changes without further notice to any products herein. ON Semiconductor makes no warranty, representation or guarantee regarding the suitability of its products for any particular purpose, nor does ON Semiconductor assume any liability arising out of the application or use of any product or circuit, and specifically disclaims any and all liability, including without limitation special, consequential or incidental damages. ON Semiconductor does not convey any license under its patent rights nor the rights of others.

onsemi, **Onsemi**, and other names, marks, and brands are registered and/or common law trademarks of Semiconductor Components Industries, LLC dba "**onsemi**" or its affiliates and/or subsidiaries in the United States and/or other countries. **onsemi** owns the rights to a number of patents, trademarks, copyrights, trade secrets, and other intellectual property. A listing of **onsemi**'s product/patent coverage may be accessed at www.onsemi.com/site/pdf/Patent-Marking.pdf. **onsemi** reserves the right to make changes at any time to any products or information herein, without notice. The information herein is provided "as-is" and **onsemi** makes no warranty, representation or guarantee regarding the accuracy of the information, product features, availability, functionality, or suitability of its products for any particular purpose, nor does **onsemi** assume any liability arising out of the application or use of any product or circuit, and specifically disclaims any and all liability, including without limitation special, consequential or incidental damages. Buyer is responsible for its products and applications using **onsemi** products, including compliance with all laws, regulations and safety requirements or standards, regardless of any support or applications information provided by **onsemi**. "Typical" parameters which may be provided in **onsemi** data sheets and/or specifications can and do vary in different applications and actual performance may vary over time. All operating parameters, including "Typicals" must be validated for each customer application by customer's technical experts. **onsemi** does not convey any license under any of its intellectual property rights nor the rights of others. **onsemi** products are not designed, intended, or authorized for use as a critical component in life support systems or any FDA Class 3 medical devices or medical devices with a same or similar classification in a foreign jurisdiction or any devices intended for implantation in the human body. Should Buyer purchase or use **onsemi** products for any such unintended or unauthorized application, Buyer shall indemnify and hold **onsemi** and its officers, employees, subsidiaries, affiliates, and distributors harmless against all claims, costs, damages, and expenses, and reasonable attorney fees arising out of, directly or indirectly, any claim of personal injury or death associated with such unintended or unauthorized use, even if such claim alleges that **onsemi** was negligent regarding the design or manufacture of the part. **onsemi** is an Equal Opportunity/Affirmative Action Employer. This literature is subject to all applicable copyright laws and is not for resale in any manner.

PUBLICATION ORDERING INFORMATION

LITERATURE FULFILLMENT:

Email Requests to: orderlit@onsemi.com

onsemi Website: www.onsemi.com

TECHNICAL SUPPORT

North American Technical Support:

Voice Mail: 1 800-282-9855 Toll Free USA/Canada

Phone: 011 421 33 790 2910

Europe, Middle East and Africa Technical Support:

Phone: 00421 33 790 2910

For additional information, please contact your local Sales Representative