

IRF7726PbF

HEXFET[®] Power MOSFET

- Ultra Low On-Resistance
- P-Channel MOSFET
- Very Small SOIC Package
- Low Profile (< 1.2mm)
- Available in Tape & Reel
- Lead-Free

V_{DS}	$R_{DS(on) \text{ max}}$	I_D
-30V	0.026@ $V_{GS} = -10V$	-7.0A
	0.040@ $V_{GS} = -4.5V$	-6.0A

Description

HEXFET[®] Power MOSFETs from International Rectifier utilize advanced processing techniques to achieve extremely low on-resistance per silicon area. This benefit, combined with the ruggedized device design, that International Rectifier is well known for, provides the designer with an extremely efficient and reliable device for battery and load management.

The new Micro8 package, with half the footprint area of the standard SO-8, provides the smallest footprint available in an SOIC outline. This makes the Micro8 an ideal device for applications where printed circuit board space is at a premium. The low profile (<1.2mm) of the Micro8 will allow it to fit easily into extremely thin application environments such as portable electronics and PCMCIA cards.

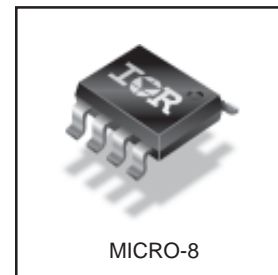
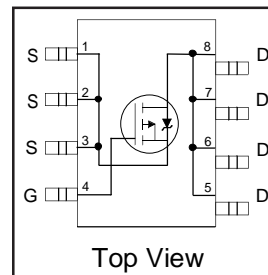

Absolute Maximum Ratings

	Parameter	Max.	Units
V_{DS}	Drain-Source Voltage	-30	V
$I_D @ T_A = 25^\circ\text{C}$	Continuous Drain Current, $V_{GS} @ -10V$	-7.0	A
$I_D @ T_A = 70^\circ\text{C}$	Continuous Drain Current, $V_{GS} @ -10V$	-5.7	
I_{DM}	Pulsed Drain Current ^①	-28	
$P_D @ T_A = 25^\circ\text{C}$	Maximum Power Dissipation ^③	1.79	W
$P_D @ T_A = 70^\circ\text{C}$	Maximum Power Dissipation ^③	1.14	W
	Linear Derating Factor	0.01	W/°C
V_{GS}	Gate-to-Source Voltage	± 20	V
T_J, T_{STG}	Junction and Storage Temperature Range	-55 to +150	°C

Thermal Resistance

	Parameter	Max.	Units
$R_{\theta JA}$	Maximum Junction-to-Ambient ^③	70	°C/W

Electrical Characteristics @ $T_J = 25^\circ\text{C}$ (unless otherwise specified)

	Parameter	Min.	Typ.	Max.	Units	Conditions
$V_{(BR)DSS}$	Drain-to-Source Breakdown Voltage	-30	—	—	V	$V_{GS} = 0V, I_D = -250\mu A$
$\Delta V_{(BR)DSS}/\Delta T_J$	Breakdown Voltage Temp. Coefficient	—	0.016	—	V/°C	Reference to $25^\circ\text{C}, I_D = -1\text{mA}$
$R_{DS(on)}$	Static Drain-to-Source On-Resistance	—	—	0.026	Ω	$V_{GS} = -10V, I_D = -7.0A$ ②
		—	—	0.040		$V_{GS} = -4.5V, I_D = -6.0A$ ②
$V_{GS(th)}$	Gate Threshold Voltage	-1.0	—	-2.5	V	$V_{DS} = V_{GS}, I_D = -250\mu A$
g_{fs}	Forward Transconductance	10	—	—	S	$V_{DS} = -10V, I_D = -7.0A$
I_{DSS}	Drain-to-Source Leakage Current	—	—	-15	μA	$V_{DS} = -24V, V_{GS} = 0V$
		—	—	-25		$V_{DS} = -24V, V_{GS} = 0V, T_J = 70^\circ\text{C}$
I_{GSS}	Gate-to-Source Forward Leakage	—	—	-100	nA	$V_{GS} = -20V$
	Gate-to-Source Reverse Leakage	—	—	100		$V_{GS} = 20V$
Q_g	Total Gate Charge	—	46	69	nC	$I_D = -7.0A$
Q_{gs}	Gate-to-Source Charge	—	8.0	—		$V_{DS} = -15V$
Q_{gd}	Gate-to-Drain ("Miller") Charge	—	8.1	—		$V_{GS} = -10V$
$t_{d(on)}$	Turn-On Delay Time	—	15	23	ns	$V_{DD} = -15V, V_{GS} = -10V$
t_r	Rise Time	—	25	38		$I_D = -1.0A$
$t_{d(off)}$	Turn-Off Delay Time	—	227	341		$R_G = 6.0\Omega$
t_f	Fall Time	—	107	161		$R_D = 15\Omega$ ②
C_{iss}	Input Capacitance	—	2204	—	pF	$V_{GS} = 0V$
C_{oss}	Output Capacitance	—	341	—		$V_{DS} = -25V$
C_{rss}	Reverse Transfer Capacitance	—	220	—		$f = 1.0\text{MHz}$

Source-Drain Ratings and Characteristics

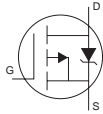
	Parameter	Min.	Typ.	Max.	Units	Conditions
I_S	Continuous Source Current (Body Diode)	—	—	-1.8	A	MOSFET symbol showing the integral reverse p-n junction diode. 
I_{SM}	Pulsed Source Current (Body Diode) ①	—	—	-28		
V_{SD}	Diode Forward Voltage	—	—	-1.2	V	$T_J = 25^\circ\text{C}, I_S = -1.8A, V_{GS} = 0V$ ②
t_{rr}	Reverse Recovery Time	—	35	53	ns	$T_J = 25^\circ\text{C}, I_F = -1.8A$
Q_{rr}	Reverse Recovery Charge	—	32	48	μC	$di/dt = -100A/\mu s$ ②

Notes:

① Repetitive rating; pulse width limited by max. junction temperature.

② Pulse width $\leq 400\mu s$; duty cycle $\leq 2\%$.

③ When mounted on 1 inch square copper board, $t < 10$ sec.

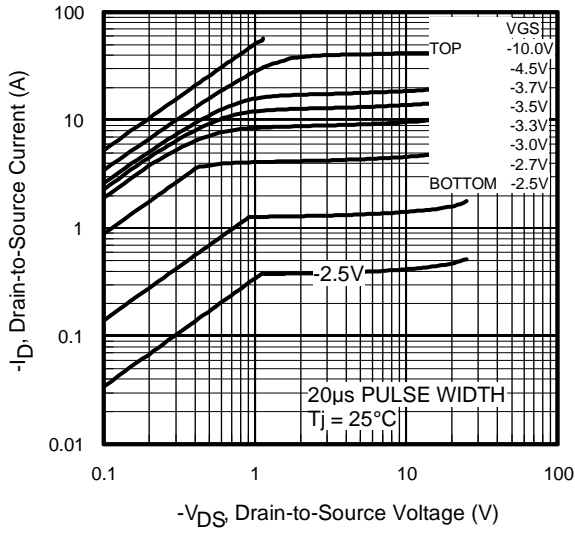

Fig 1. Typical Output Characteristics

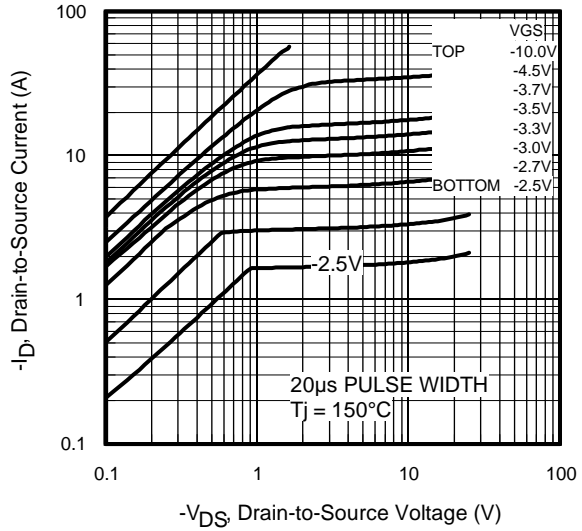

Fig 2. Typical Output Characteristics

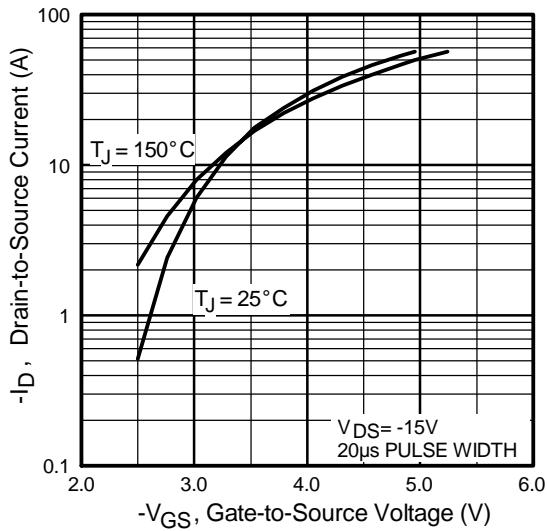

Fig 3. Typical Transfer Characteristics

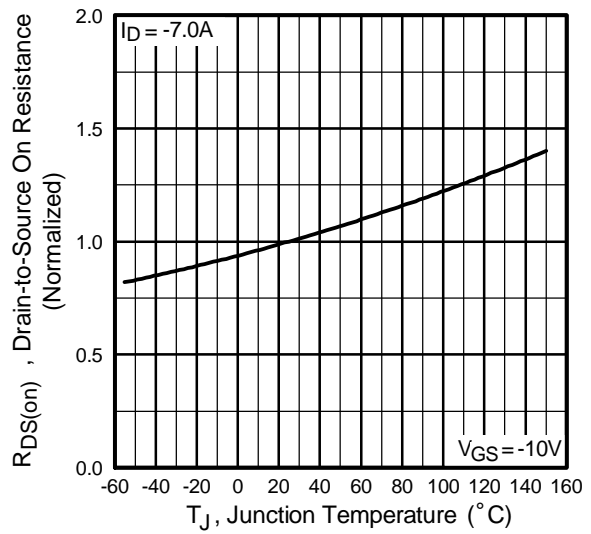

Fig 4. Normalized On-Resistance Vs. Temperature

IRF7726PbF

International
IR Rectifier

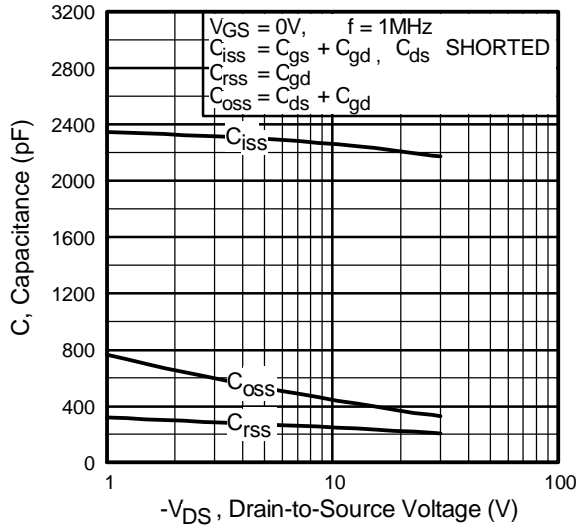

Fig 5. Typical Capacitance Vs. Drain-to-Source Voltage

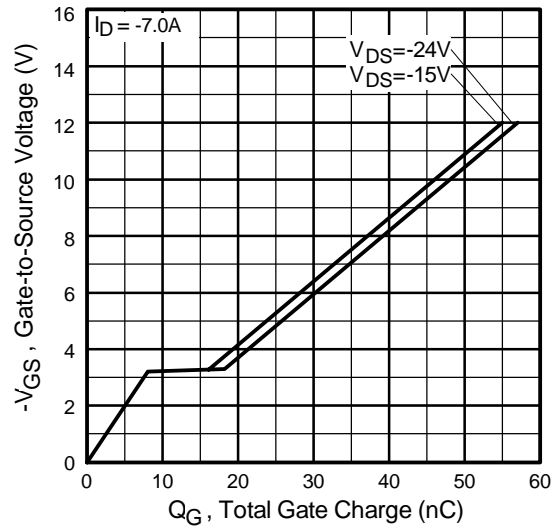

Fig 6. Typical Gate Charge Vs. Gate-to-Source Voltage

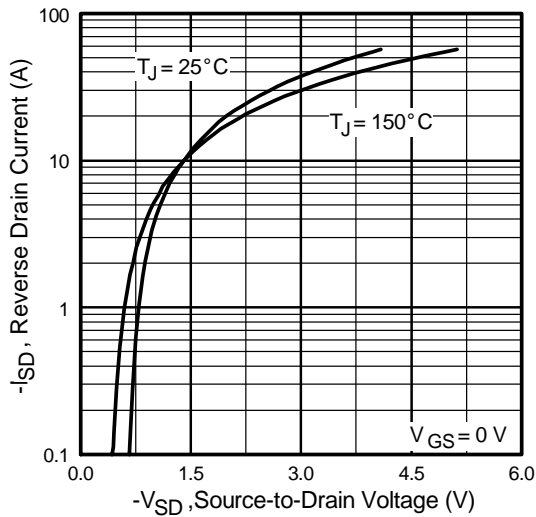

Fig 7. Typical Source-Drain Diode Forward Voltage

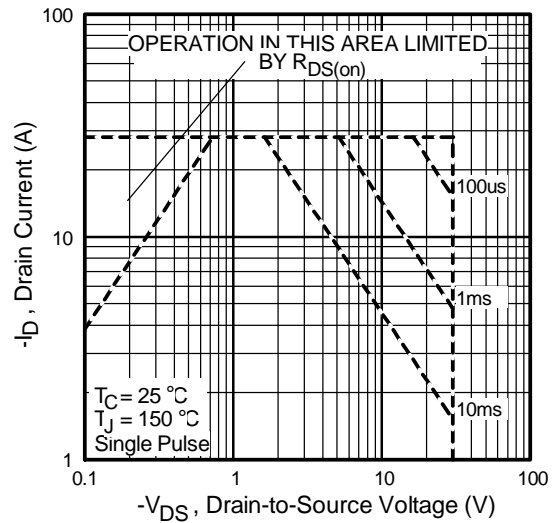

Fig 8. Maximum Safe Operating Area

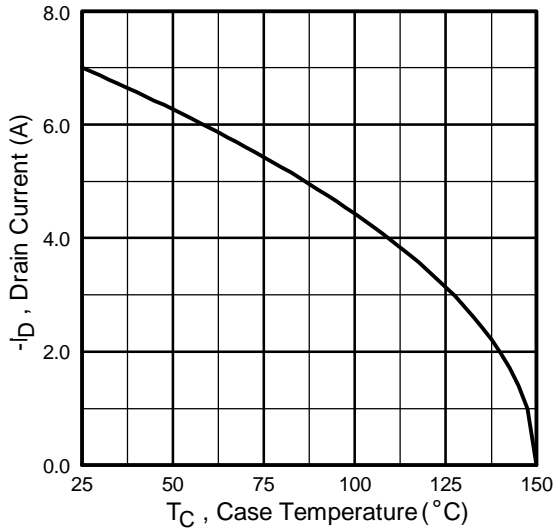

Fig 9. Maximum Drain Current Vs. Case Temperature

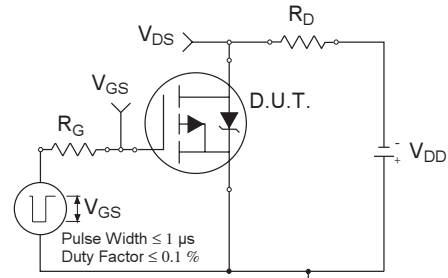

Fig 10a. Switching Time Test Circuit

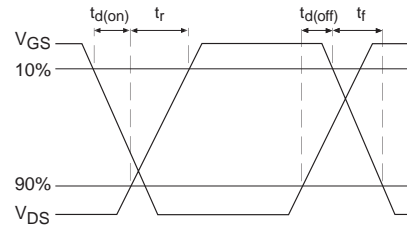

Fig 10b. Switching Time Waveforms

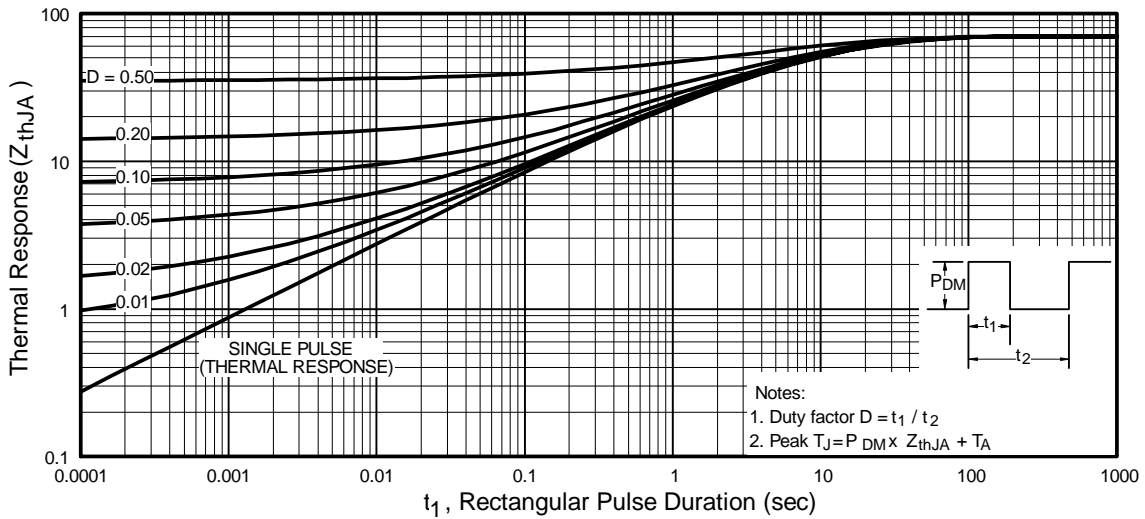

Fig 11. Maximum Effective Transient Thermal Impedance, Junction-to-Ambient

IRF7726PbF

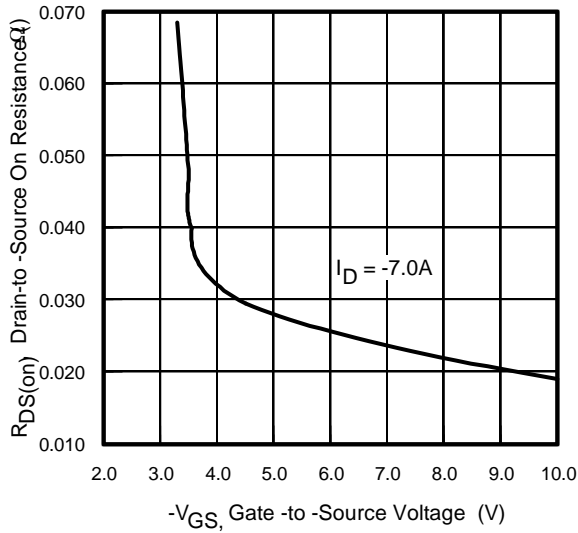

Fig 12. Typical On-Resistance Vs. Gate Voltage

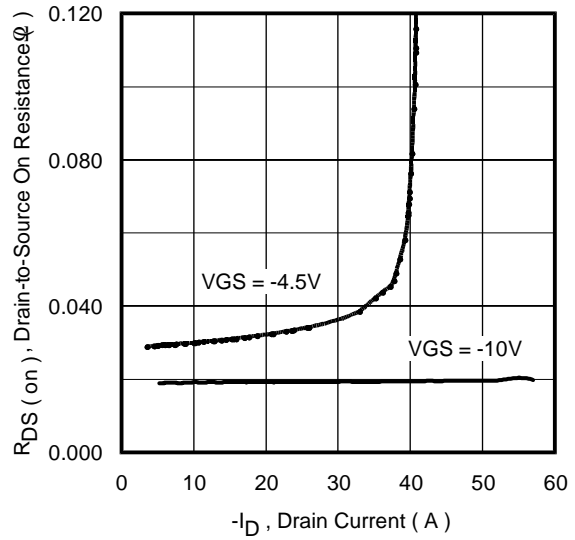

Fig 13. Typical On-Resistance Vs. Drain Current

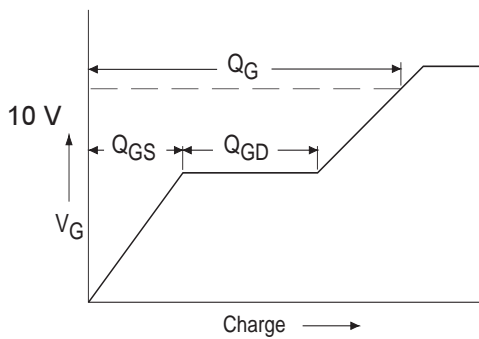

Fig 14a. Basic Gate Charge Waveform

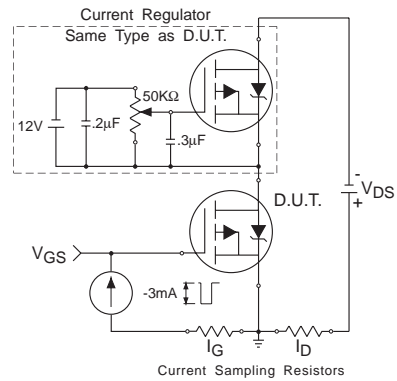

Fig 14b. Gate Charge Test Circuit

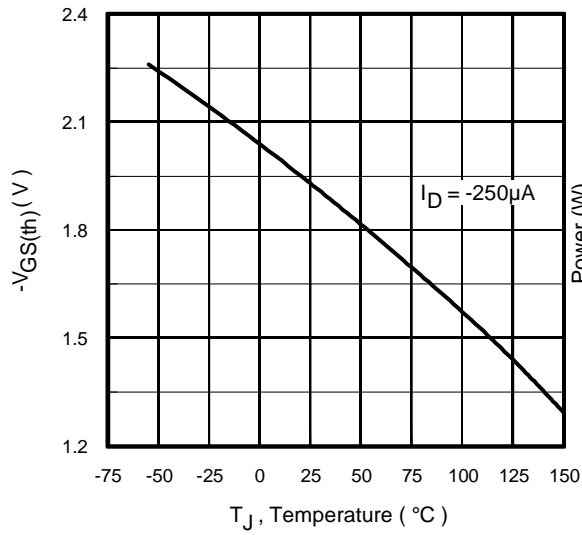

Fig 15. Typical $V_{GS(th)}$ Vs. Junction Temperature

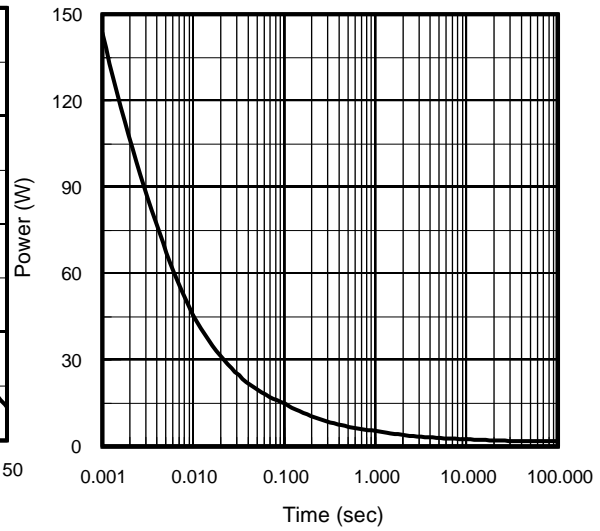
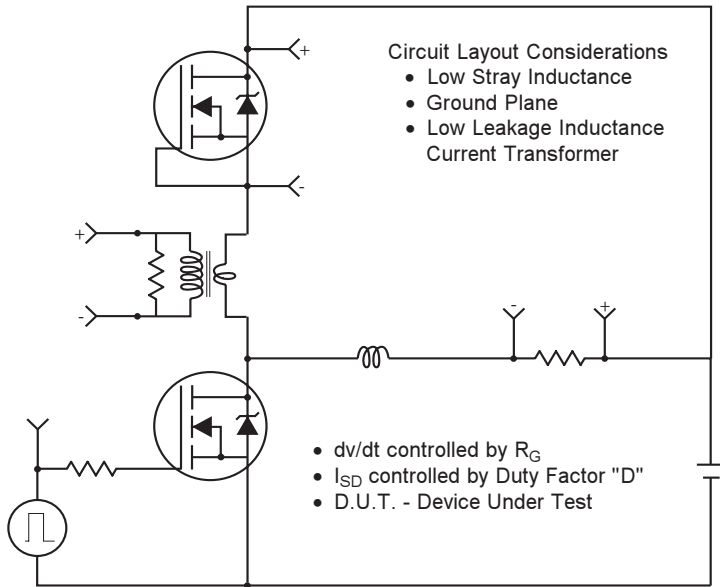

Fig 16. Typical Power Vs. Time

Peak Diode Recovery dv/dt Test Circuit



* Reverse Polarity for P-Channel

** Use P-Channel Driver for P-Channel Measurements

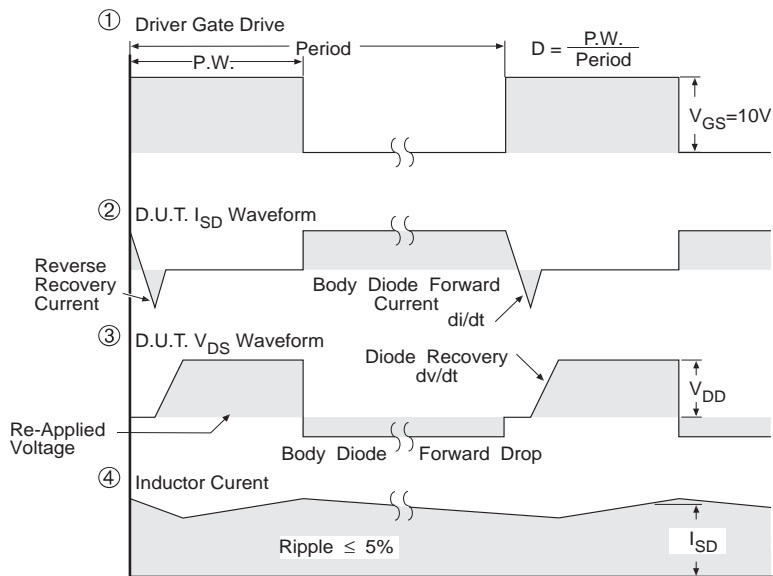

*** $V_{GS} = 5.0V$ for Logic Level and 3V Drive Devices

Fig 17 For P Channel HEXFETS

Micro8 Package Outline

Dimensions are shown in millimeters (inches)

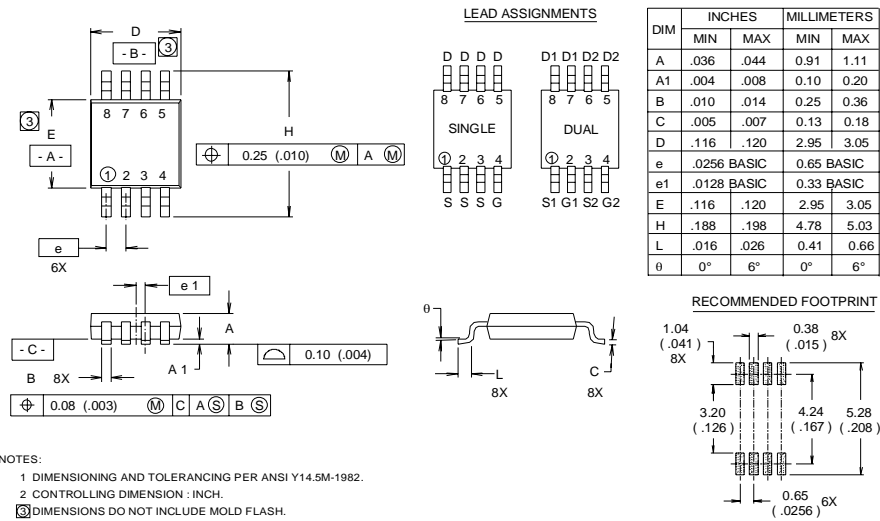

Micro8 Part Marking Information

EXAMPLE: THIS IS AN IRF 7501

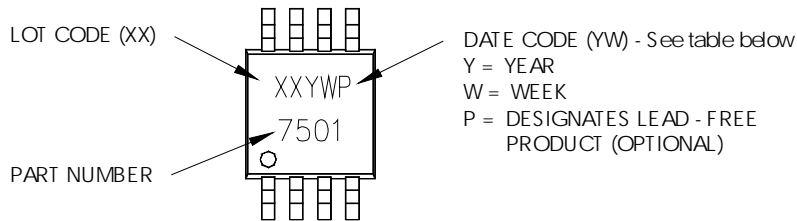

WW = (1-26) IF PRECEDED BY LAST DIGIT OF CALENDAR YEAR

YEAR	Y	WORK WEEK	W
2001	1	01	A
2002	2	02	B
2003	3	03	C
2004	4	04	D
2005	5		
2006	6		
2007	7		
2008	8		
2009	9		
2010	0	24	X
		25	Y
		26	Z

WW = (27-52) IF PRECEDED BY A LETTER

YEAR	Y	WORK WEEK	W
2001	A	27	A
2002	B	28	B
2003	C	29	C
2004	D	30	D
2005	E		
2006	F		
2007	G		
2008	H		
2009	J		
2010	K	50	X
		51	Y
		52	Z

IRF7726PbF

International
IR Rectifier

Micro8 Tape & Reel Information

Dimensions are shown in millimeters (inches)

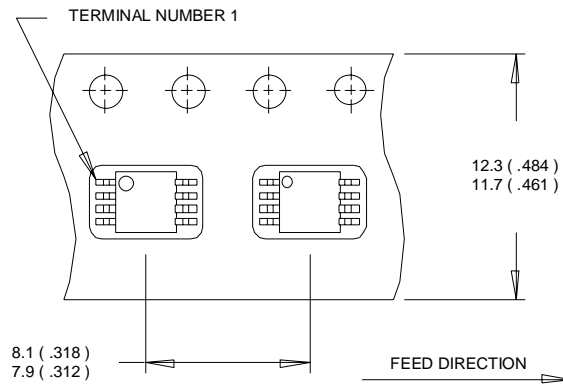

NOTES:

1. OUTLINE CONFORMS TO EIA-481 & EIA-541.
2. CONTROLLING DIMENSION : MILLIMETER.

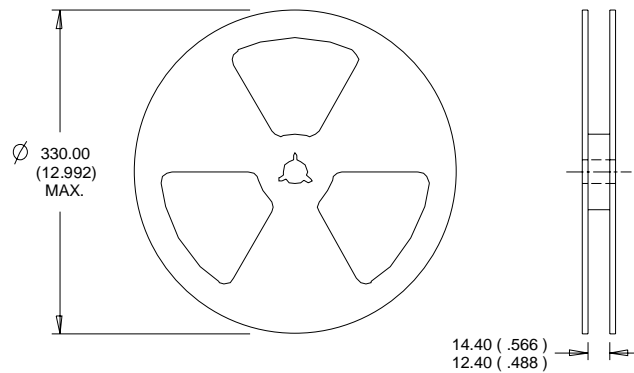

NOTES:

1. CONTROLLING DIMENSION : MILLIMETER.
2. OUTLINE CONFORMS TO EIA-481 & EIA-541.

Data and specifications subject to change without notice.
This product has been designed and qualified for the Consumer market.
Qualifications Standards can be found on IR's Web site.

International
IR Rectifier

IR WORLD HEADQUARTERS: 233 Kansas St., El Segundo, California 90245, USA Tel: (310) 252-7105
TAC Fax: (310) 252-7903

Visit us at www.irf.com for sales contact information.02/05

www.irf.com

IMPORTANT NOTICE

The information given in this document shall in no event be regarded as a guarantee of conditions or characteristics ("Beschaffheitsgarantie").

With respect to any examples, hints or any typical values stated herein and/or any information regarding the application of the product, Infineon Technologies hereby disclaims any and all warranties and liabilities of any kind, including without limitation warranties of non-infringement of intellectual property rights of any third party.

In addition, any information given in this document is subject to customer's compliance with its obligations stated in this document and any applicable legal requirements, norms and standards concerning customer's products and any use of the product of Infineon Technologies in customer's applications.

The data contained in this document is exclusively intended for technically trained staff. It is the responsibility of customer's technical departments to evaluate the suitability of the product for the intended application and the completeness of the product information given in this document with respect to such application.

For further information on the product, technology, delivery terms and conditions and prices please contact your nearest Infineon Technologies office (www.infineon.com).

WARNINGS

Due to technical requirements products may contain dangerous substances. For information on the types in question please contact your nearest Infineon Technologies office.

Except as otherwise explicitly approved by Infineon Technologies in a written document signed by authorized representatives of Infineon Technologies, Infineon Technologies' products may not be used in any applications where a failure of the product or any consequences of the use thereof can reasonably be expected to result in personal injury.