

IRF7455PbF

SMPS MOSFET

HEXFET® Power MOSFET

Applications

- High Frequency DC-DC Converters with Synchronous Rectification
- Lead-Free

Benefits

- Ultra-Low $R_{DS(on)}$ at 4.5V V_{GS}
- Low Charge and Low Gate Impedance to Reduce Switching Losses
- Fully Characterized Avalanche Voltage and Current

V_{DSS}	$R_{DS(on)}$ max	I_D
30V	0.0075 Ω	15A

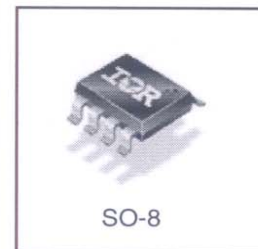
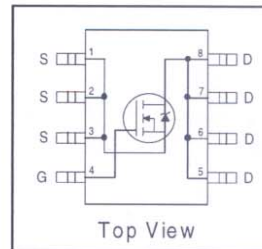

Absolute Maximum Ratings

Symbol	Parameter	Max.	Units
V_{DS}	Drain-Source Voltage	30	V
V_{GS}	Gate-to-Source Voltage	± 12	V
I_D @ $T_A = 25^\circ\text{C}$	Continuous Drain Current, V_{GS} @ 10V	15	A
I_D @ $T_A = 70^\circ\text{C}$	Continuous Drain Current, V_{GS} @ 10V	12	
I_{DM}	Pulsed Drain Current ^①	120	
P_D @ $T_A = 25^\circ\text{C}$	Maximum Power Dissipation ^③	2.5	W
P_D @ $T_A = 70^\circ\text{C}$	Maximum Power Dissipation ^③	1.6	W
	Linear Derating Factor	0.02	W/ $^\circ\text{C}$
T_J, T_{STG}	Junction and Storage Temperature Range	-55 to + 150	$^\circ\text{C}$

Thermal Resistance

	Parameter	Max.	Units
$R_{\theta JA}$	Maximum Junction-to-Ambient ^④	50	$^\circ\text{C}/\text{W}$

Typical SMPS Topologies

- Telecom 48V Input Converters with Logic-Level Driven Synchronous Rectifiers

Notes ① through ④ are on page 8

Static @ $T_J = 25^\circ\text{C}$ (unless otherwise specified)

	Parameter	Min.	Typ.	Max.	Units	Conditions
$V_{(BR)DSS}$	Drain-to-Source Breakdown Voltage	30	—	—	V	$V_{GS} = 0V, I_D = 250\mu A$
$\Delta V_{(BR)DSS}/\Delta T_J$	Breakdown Voltage Temp. Coefficient	—	0.029	—	V/ $^\circ\text{C}$	Reference to $25^\circ\text{C}, I_D = 1mA$
$R_{DS(on)}$	Static Drain-to-Source On-Resistance	—	0.0060	0.0075	Ω	$V_{GS} = 10V, I_D = 15A$ ④
		—	0.0069	0.009		$V_{GS} = 4.5V, I_D = 12A$ ④
		—	0.010	0.020		$V_{GS} = 2.8V, I_D = 3.5A$ ④
$V_{GS(th)}$	Gate Threshold Voltage	0.6	—	2.0	V	$V_{DS} = V_{GS}, I_D = 250\mu A$
I_{DSS}	Drain-to-Source Leakage Current	—	—	20	μA	$V_{DS} = 24V, V_{GS} = 0V$
		—	—	100		$V_{DS} = 24V, V_{GS} = 0V, T_J = 125^\circ\text{C}$
I_{GSS}	Gate-to-Source Forward Leakage	—	—	200	nA	$V_{GS} = 12V$
	Gate-to-Source Reverse Leakage	—	—	-200		$V_{GS} = -12V$

Dynamic @ $T_J = 25^\circ\text{C}$ (unless otherwise specified)

	Parameter	Min.	Typ.	Max.	Units	Conditions
g_{fs}	Forward Transconductance	44	—	—	S	$V_{DS} = 10V, I_D = 15A$
Q_g	Total Gate Charge	—	37	56	nC	$I_D = 15A$ $V_{DS} = 24V$ $V_{GS} = 5.0V$, ③
Q_{gs}	Gate-to-Source Charge	—	8.9	13		
Q_{gd}	Gate-to-Drain ("Miller") Charge	—	13	20		
$t_{d(on)}$	Turn-On Delay Time	—	17	—		
t_r	Rise Time	—	18	—	ns	$V_{DD} = 15V$ $I_D = 1.0A$ $R_G = 6.0\Omega$ $V_{GS} = 4.5V$ ③
$t_{d(off)}$	Turn-Off Delay Time	—	51	—		
t_f	Fall Time	—	44	—		
C_{iss}	Input Capacitance	—	3480	—	pF	$V_{GS} = 0V$ $V_{DS} = 25V$ $f = 1.0MHz$
C_{oss}	Output Capacitance	—	870	—		
C_{riss}	Reverse Transfer Capacitance	—	100	—		

Avalanche Characteristics

	Parameter	Typ.	Max.	Units
E_{AS}	Single Pulse Avalanche Energy②	—	200	mJ
I_{AR}	Avalanche Current①	—	15	A
E_{AR}	Repetitive Avalanche Energy①	—	0.25	mJ

Diode Characteristics

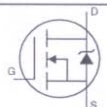
	Parameter	Min.	Typ.	Max.	Units	Conditions
I_S	Continuous Source Current (Body Diode)	—	—	2.5	A	MOSFET symbol showing the integral reverse p-n junction diode. 
I_{SM}	Pulsed Source Current (Body Diode) ①	—	—	120		
V_{SD}	Diode Forward Voltage	—	—	1.2	V	$T_J = 25^\circ\text{C}, I_S = 2.5A, V_{GS} = 0V$ ③
t_{rr}	Reverse Recovery Time	—	64	96	ns	$T_J = 25^\circ\text{C}, I_F = 2.5A$
Q_{rr}	Reverse Recovery Charge	—	99	150	nC	$di/dt = 100A/\mu s$ ③

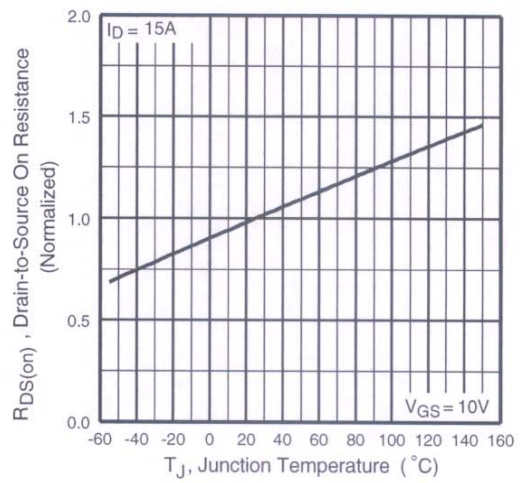
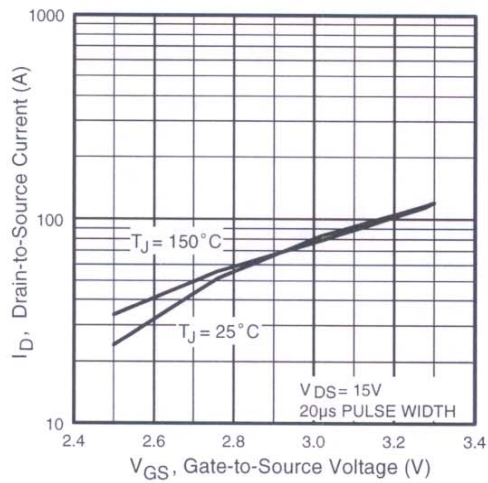
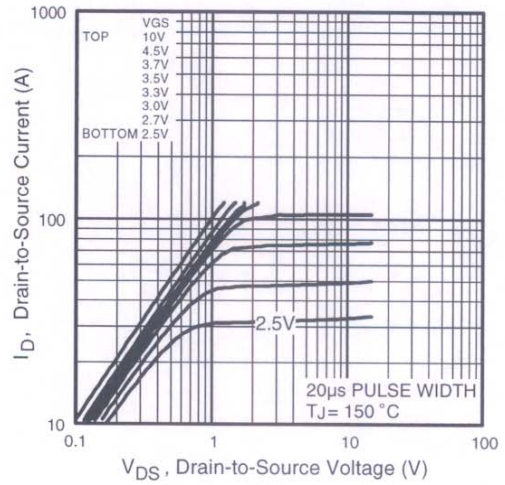
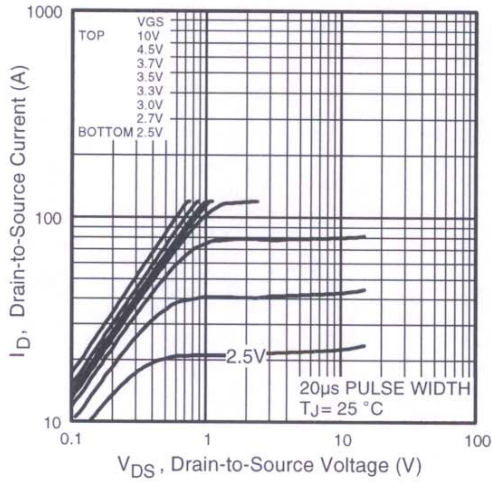

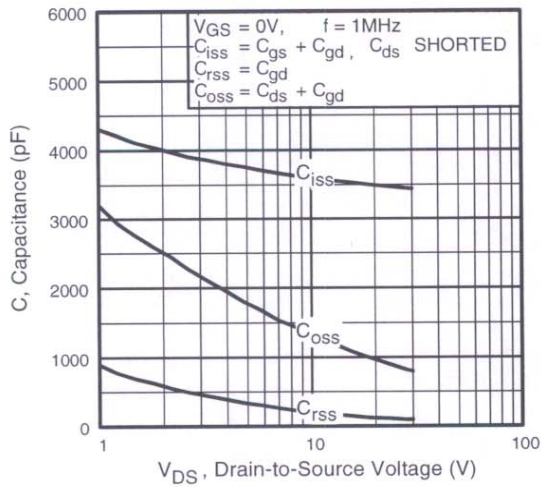

Fig 5. Typical Capacitance Vs. Drain-to-Source Voltage

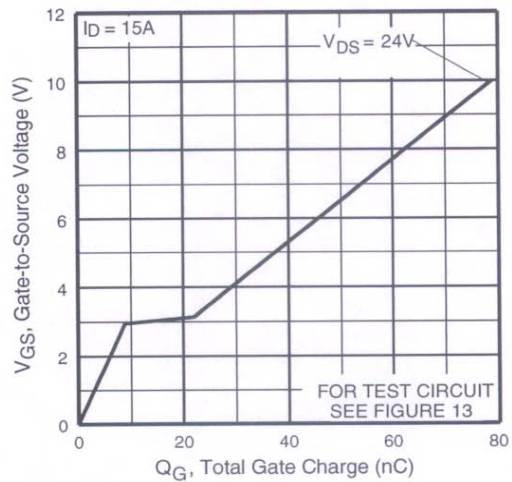

Fig 6. Typical Gate Charge Vs. Gate-to-Source Voltage

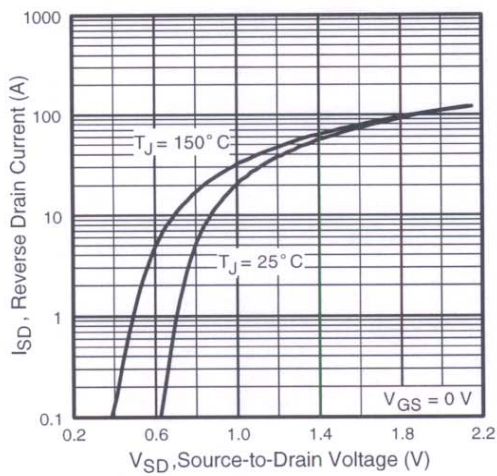

Fig 7. Typical Source-Drain Diode Forward Voltage

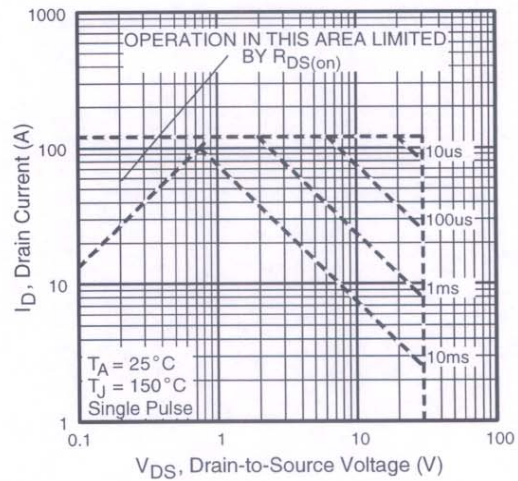

Fig 8. Maximum Safe Operating Area

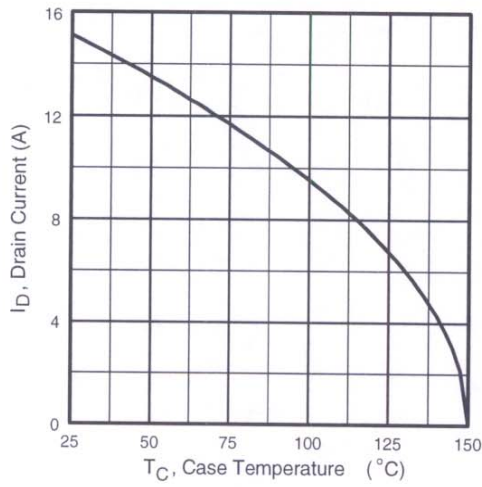

Fig 9. Maximum Drain Current Vs. Case Temperature

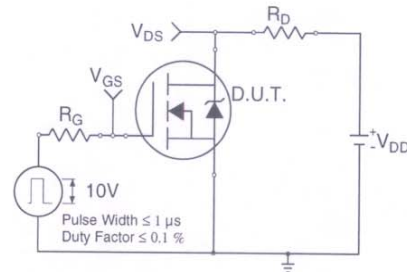

Fig 10a. Switching Time Test Circuit

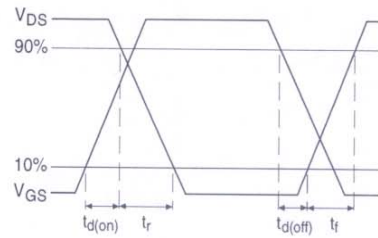

Fig 10b. Switching Time Waveforms

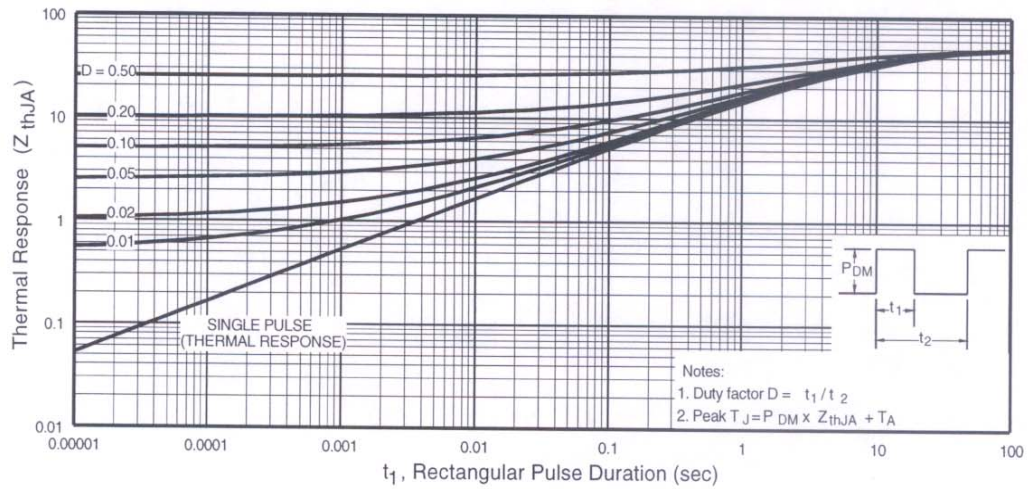

Fig 11. Maximum Effective Transient Thermal Impedance, Junction-to-Ambient

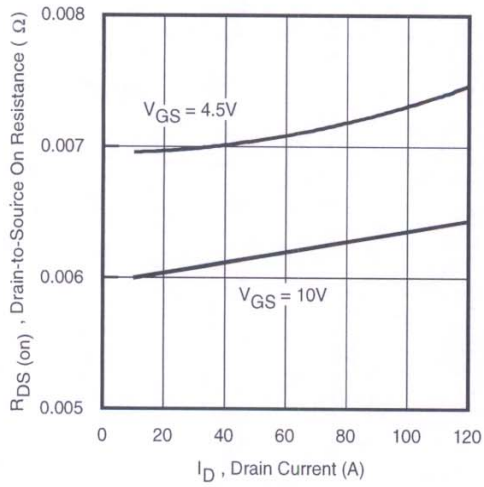

Fig 12. On-Resistance Vs. Drain Current

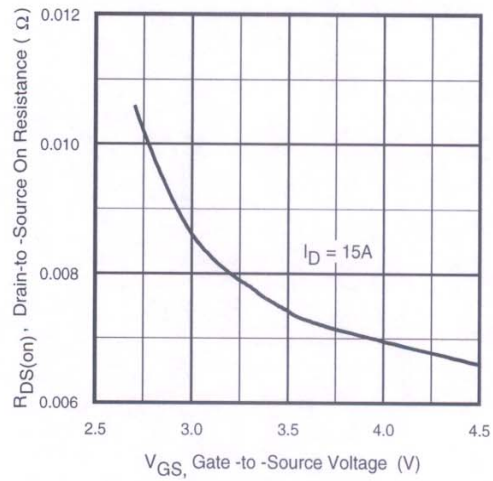

Fig 13. On-Resistance Vs. Gate Voltage

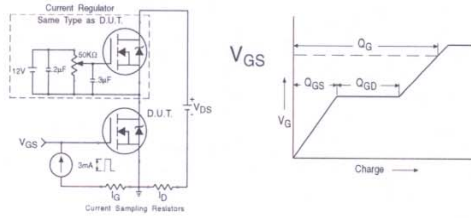

Fig 13a&b. Basic Gate Charge Test Circuit and Waveform

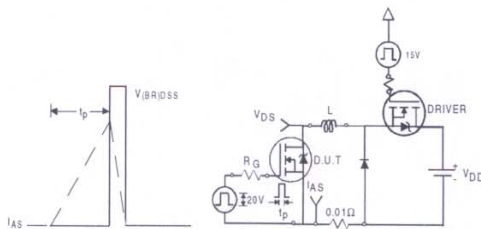

Fig 14a&b. Unclamped Inductive Test circuit and Waveforms

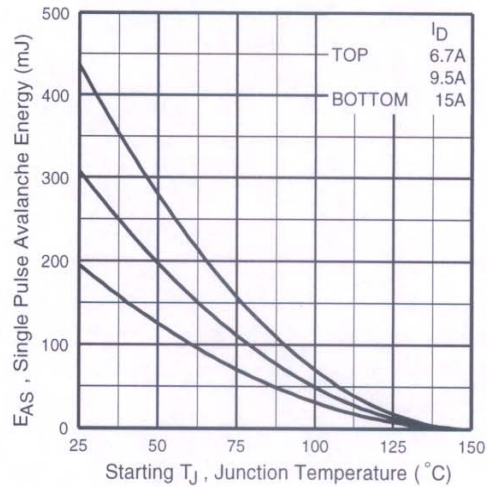
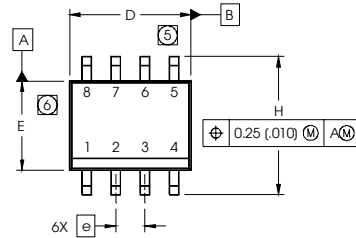

Fig 14c. Maximum Avalanche Energy Vs. Drain Current

SO-8 Package Outline

Dimensions are shown in millimeters (inches)



DIM	INCHES		MILLIMETERS	
	MIN	MAX	MIN	MAX
A	.0532	.0688	1.35	1.75
A1	.0040	.0098	0.10	0.25
b	.013	.020	0.33	0.51
c	.0075	.0098	0.19	0.25
D	.189	.1968	4.80	5.00
E	.1497	.1574	3.80	4.00
e	.050 BASIC		1.27 BASIC	
e1	.025 BASIC		0.635 BASIC	
H	.2284	.2440	5.80	6.20
K	.0099	.0196	0.25	0.50
L	.016	.050	0.40	1.27
y	0°	8°	0°	8°

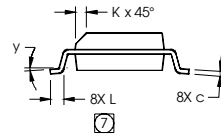
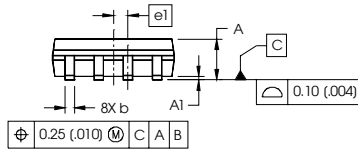

- NOTES:
1. DIMENSIONING & TOLERANCING PER ASME Y14.5M-1994.
 2. CONTROLLING DIMENSION: MILLIMETER
 3. DIMENSIONS ARE SHOWN IN MILLIMETERS (INCHES).
 4. OUTLINE CONFORMS TO JEDEC OUTLINE MS-012AA.
 - ⑤ DIMENSION DOES NOT INCLUDE MOLD PROTRUSIONS. MOLD PROTRUSIONS NOT TO EXCEED 0.15 (.006).
 - ⑥ DIMENSION DOES NOT INCLUDE MOLD PROTRUSIONS. MOLD PROTRUSIONS NOT TO EXCEED 0.25 (.010).
 - ⑦ DIMENSION IS THE LENGTH OF LEAD FOR SOLDERING TO A SUBSTRATE.

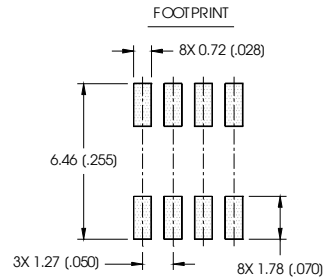

SO-8 Part Marking Information (Lead-Free)

EXAMPLE: THIS IS AN IRF7101 (MOSFET)

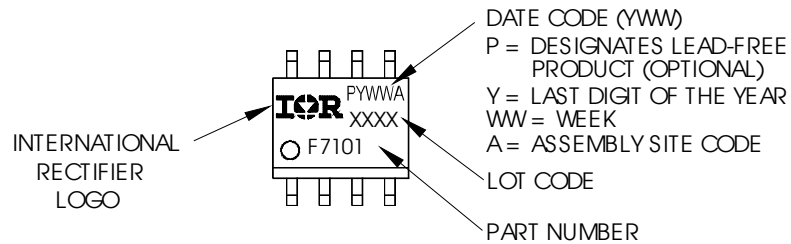

IRF7455PbF

International
IR Rectifier

SO-8 Tape and Reel

Dimensions are shown in millimeters (inches)

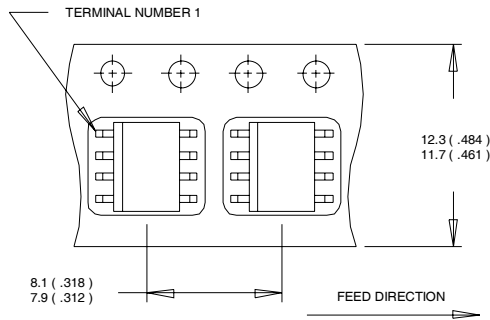

NOTES:

1. CONTROLLING DIMENSION : MILLIMETER.
2. ALL DIMENSIONS ARE SHOWN IN MILLIMETERS(INCHES).
3. OUTLINE CONFORMS TO EIA-481 & EIA-541.

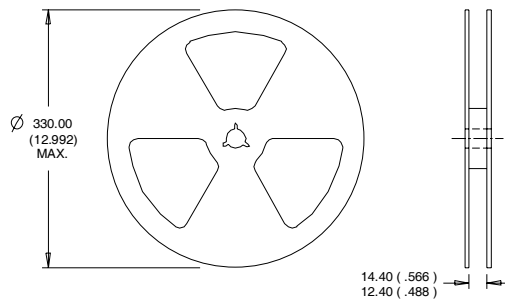

NOTES :

1. CONTROLLING DIMENSION : MILLIMETER.
2. OUTLINE CONFORMS TO EIA-481 & EIA-541.

Notes:

- ① Repetitive rating; pulse width limited by max. junction temperature.
- ② Starting $T_J = 25^\circ\text{C}$, $L = 1.8\text{mH}$
 $R_G = 25\Omega$, $I_{AS} = 15\text{A}$.
- ③ Pulse width $\leq 300\mu\text{s}$; duty cycle $\leq 2\%$.
- ④ When mounted on 1 inch square copper board, $t < 10$ sec

Data and specifications subject to change without notice.
This product has been designed and qualified for the Consumer market.
Qualifications Standards can be found on IR's Web site.

International
IR Rectifier

IR WORLD HEADQUARTERS: 233 Kansas St., El Segundo, California 90245, USA Tel: (310) 252-7105
TAC Fax: (310) 252-7903

Visit us at www.irf.com for sales contact information.06/04

www.irf.com

IMPORTANT NOTICE

The information given in this document shall in no event be regarded as a guarantee of conditions or characteristics ("Beschaffheitsgarantie").

With respect to any examples, hints or any typical values stated herein and/or any information regarding the application of the product, Infineon Technologies hereby disclaims any and all warranties and liabilities of any kind, including without limitation warranties of non-infringement of intellectual property rights of any third party.

In addition, any information given in this document is subject to customer's compliance with its obligations stated in this document and any applicable legal requirements, norms and standards concerning customer's products and any use of the product of Infineon Technologies in customer's applications.

The data contained in this document is exclusively intended for technically trained staff. It is the responsibility of customer's technical departments to evaluate the suitability of the product for the intended application and the completeness of the product information given in this document with respect to such application.

For further information on the product, technology, delivery terms and conditions and prices please contact your nearest Infineon Technologies office (www.infineon.com).

WARNINGS

Due to technical requirements products may contain dangerous substances. For information on the types in question please contact your nearest Infineon Technologies office.

Except as otherwise explicitly approved by Infineon Technologies in a written document signed by authorized representatives of Infineon Technologies, Infineon Technologies' products may not be used in any applications where a failure of the product or any consequences of the use thereof can reasonably be expected to result in personal injury.