

E Series Power MOSFET with Fast Body Diode

PRODUCT SUMMARY	
V_{DS} (V) at T_J max.	700
$R_{DS(on)}$ typ. (Ω) at 25 °C	$V_{GS} = 10$ V 0.157
Q_g max. (nC)	102
Q_{gs} (nC)	15
Q_{gd} (nC)	28
Configuration	Single

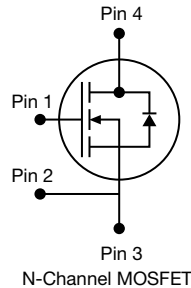
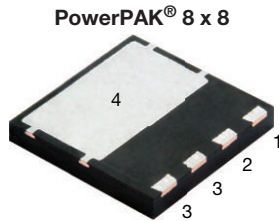

FEATURES

- Completely lead (Pb)-free device
- Low figure-of-merit (FOM) $R_{on} \times Q_g$
- Low input capacitance (C_{iss})
- Reduced switching and conduction losses
- Ultra low gate charge (Q_g)
- Avalanche energy rated (UIS)
- Material categorization: for definitions of compliance please see www.vishay.com/doc?99912



RoHS
COMPLIANT
HALOGEN
FREE

APPLICATIONS

- Server and telecom power supplies
- Switch mode power supplies (SMPS)
- Power factor correction power supplies (PFC)
- Lighting
 - High-intensity discharge (HID)
 - Fluorescent ballast lighting
- Industrial
 - Welding
 - Induction heating
 - Motor drives
 - Battery chargers
 - Renewable energy
 - Solar (PV inverters)

ORDERING INFORMATION	
Package	PowerPAK 8 x 8
Lead (Pb)-free and Halogen-free	SiHH21N65EF-T1-GE3

ABSOLUTE MAXIMUM RATINGS ($T_C = 25$ °C, unless otherwise noted)			
PARAMETER	SYMBOL	LIMIT	UNIT
Drain-Source Voltage	V_{DS}	650	V
Gate-Source Voltage	V_{GS}	± 30	
Continuous Drain Current ($T_J = 150$ °C)	V_{GS} at 10 V	$T_C = 25$ °C	19.8
		$T_C = 100$ °C	12.5
Pulsed Drain Current ^a	I_{DM}	53	A
Linear Derating Factor		1.47	W/°C
Single Pulse Avalanche Energy ^b	E_{AS}	353	mJ
Maximum Power Dissipation	P_D	156	W
Operating Junction and Storage Temperature Range	T_J, T_{stg}	-55 to +150	°C
Drain-Source Voltage Slope	dV/dt	$T_J = 125$ °C	70
Reverse Diode dV/dt ^c		10	

Notes

- Repetitive rating; pulse width limited by maximum junction temperature.
- $V_{DD} = 140$ V, starting $T_J = 25$ °C, $L = 28.2$ mH, $R_g = 25$ Ω , $I_{AS} = 5$ A.
- $I_{SD} \leq I_D$, $dI/dt = 100$ A/ μ s, starting $T_J = 25$ °C.



THERMAL RESISTANCE RATINGS				
PARAMETER	SYMBOL	TYP.	MAX.	UNIT
Maximum Junction-to-Ambient	R _{thJA}	39	51	°C/W
Maximum Junction-to-Case (Drain)	R _{thJC}	0.51	0.68	

SPECIFICATIONS (T _J = 25 °C, unless otherwise noted)							
PARAMETER	SYMBOL	TEST CONDITIONS		MIN.	TYP.	MAX.	UNIT
Static							
Drain-Source Breakdown Voltage	V _{DS}	V _{GS} = 0 V, I _D = 250 μA		650	-	-	V
V _{DS} Temperature Coefficient	ΔV _{DS} /T _J	Reference to 25 °C, I _D = 10 mA		-	0.70	-	V/°C
Gate-Source Threshold Voltage (N)	V _{GS(th)}	V _{DS} = V _{GS} , I _D = 250 μA		2.0	-	4.0	V
Gate-Source Leakage	I _{GSS}	V _{GS} = ± 20 V		-	-	± 100	nA
		V _{GS} = ± 30 V		-	-	± 1	μA
Zero Gate Voltage Drain Current	I _{DSS}	V _{DS} = 520 V, V _{GS} = 0 V		-	-	1	μA
		V _{DS} = 520 V, V _{GS} = 0 V, T _J = 125 °C		-	-	100	
Drain-Source On-State Resistance	R _{DS(on)}	V _{GS} = 10 V	I _D = 11 A	-	0.157	0.180	Ω
Forward Transconductance	g _{fs}	V _{DS} = 30 V, I _D = 11 A		-	7.8	-	S
Dynamic							
Input Capacitance	C _{iss}	V _{GS} = 0 V, V _{DS} = 100 V, f = 1 MHz		-	2396	-	pF
Output Capacitance	C _{oss}			-	99	-	
Reverse Transfer Capacitance	C _{rss}			-	2	-	
Effective Output Capacitance, Energy Related ^a	C _{o(er)}			-	74	-	
Effective Output Capacitance, Time Related ^b	C _{o(tr)}	V _{DS} = 0 V to 520 V, V _{GS} = 0 V		-	316	-	
Total Gate Charge	Q _g	V _{GS} = 10 V	I _D = 11 A, V _{DS} = 520 V	-	68	102	nC
Gate-Source Charge	Q _{gs}			-	15	-	
Gate-Drain Charge	Q _{gd}			-	28	-	
Turn-On Delay Time	t _{d(on)}	V _{DD} = 520 V, I _D = 11 A, V _{GS} = 10 V, R _g = 9.1 Ω		-	24	48	ns
Rise Time	t _r			-	43	86	
Turn-Off Delay Time	t _{d(off)}			-	72	108	
Fall Time	t _f			-	46	92	
Gate Input Resistance	R _g			f = 1 MHz, open drain		0.27	
Drain-Source Body Diode Characteristics							
Continuous Source-Drain Diode Current	I _S	MOSFET symbol showing the integral reverse p - n junction diode 		-	-	19.8	A
Pulsed Diode Forward Current	I _{SM}			-	-	53	
Diode Forward Voltage	V _{SD}	T _J = 25 °C, I _S = 11 A, V _{GS} = 0 V		-	0.95	1.3	V
Reverse Recovery Time	t _{rr}	T _J = 25 °C, I _F = I _S = 11 A, dI/dt = 100 A/μs, V _R = 25 V		-	145	290	ns
Reverse Recovery Charge	Q _{rr}			-	0.9	1.8	μC
Reverse Recovery Current	I _{RRM}			-	11.6	-	A

Notes

- a. C_{oss(er)} is a fixed capacitance that gives the same energy as C_{oss} while V_{DS} is rising from 0 % to 80 % V_{DS}.
- b. C_{oss(tr)} is a fixed capacitance that gives the same charging time as C_{oss} while V_{DS} is rising from 0 % to 80 % V_{DS}.



TYPICAL CHARACTERISTICS (25 °C, unless otherwise noted)

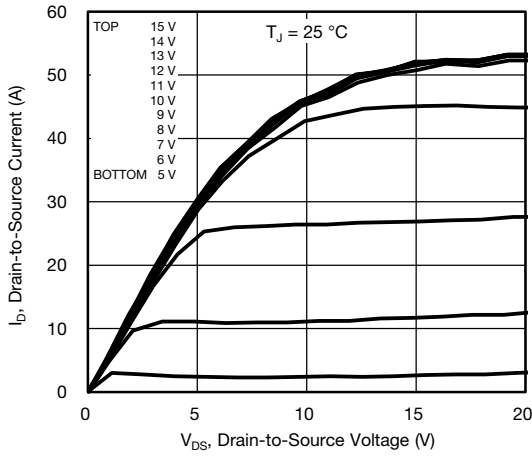

Fig. 1 - Typical Output Characteristics

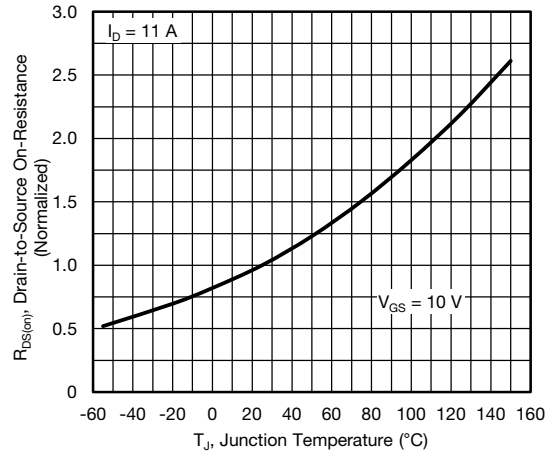

Fig. 4 - Normalized On-Resistance vs. Temperature

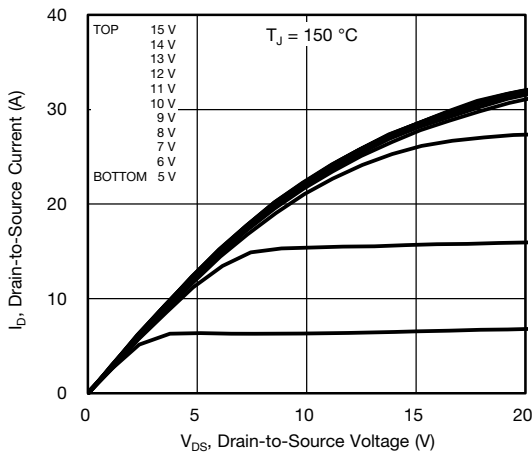

Fig. 2 - Typical Output Characteristics

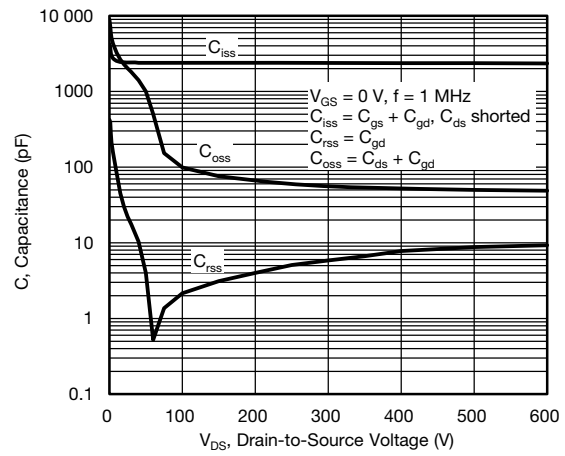

Fig. 5 - Typical Capacitance vs. Drain-to-Source Voltage

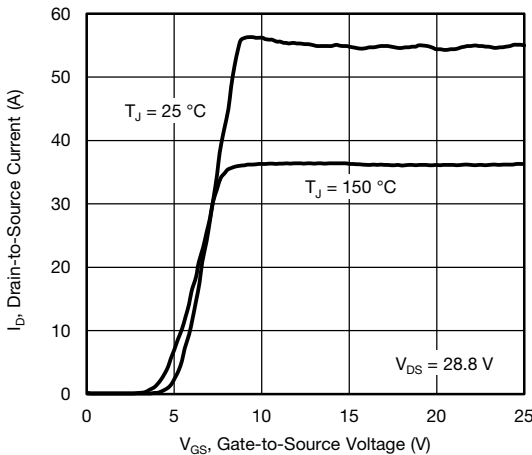

Fig. 3 - Typical Transfer Characteristics

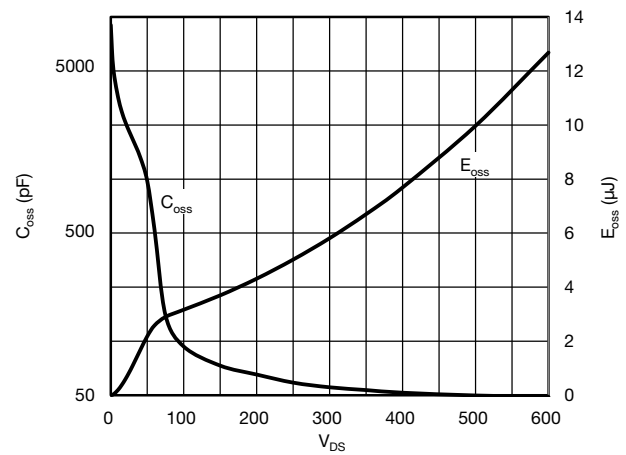

Fig. 6 - C_{oss} and E_{oss} vs. V_{DS}

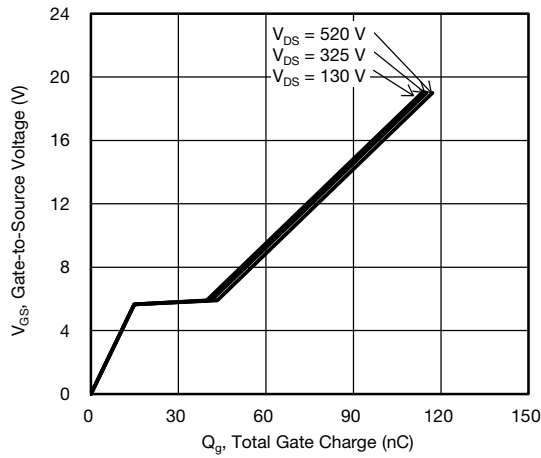

Fig. 7 - Typical Gate Charge vs. Gate-to-Source Voltage

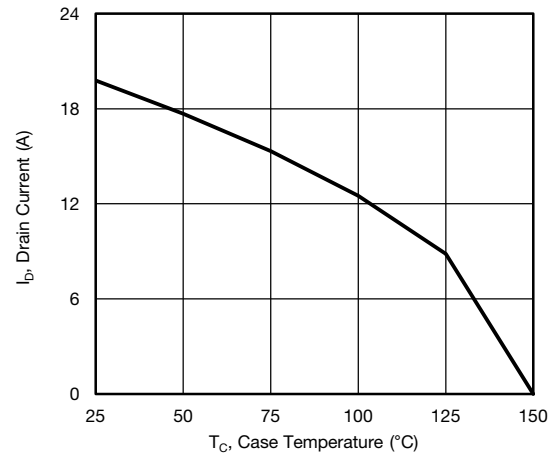

Fig. 10 - Maximum Drain Current vs. Case Temperature

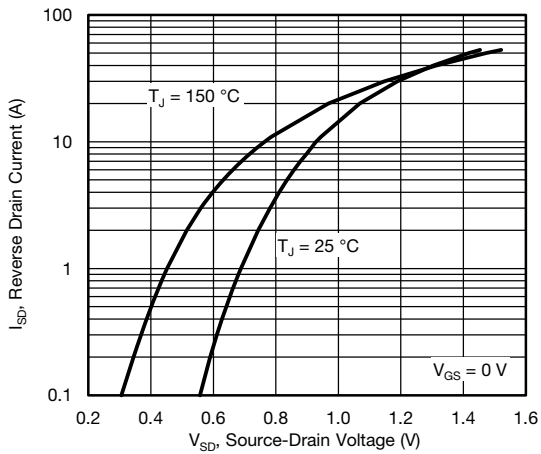

Fig. 8 - Typical Source-Drain Diode Forward Voltage

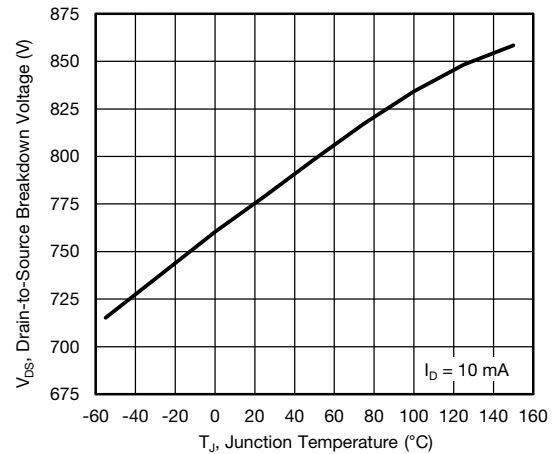

Fig. 11 - Temperature vs. Drain-to-Source Voltage

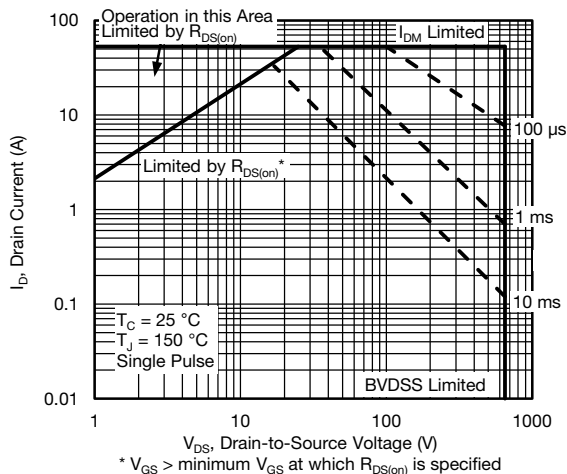

Fig. 9 - Maximum Safe Operating Area

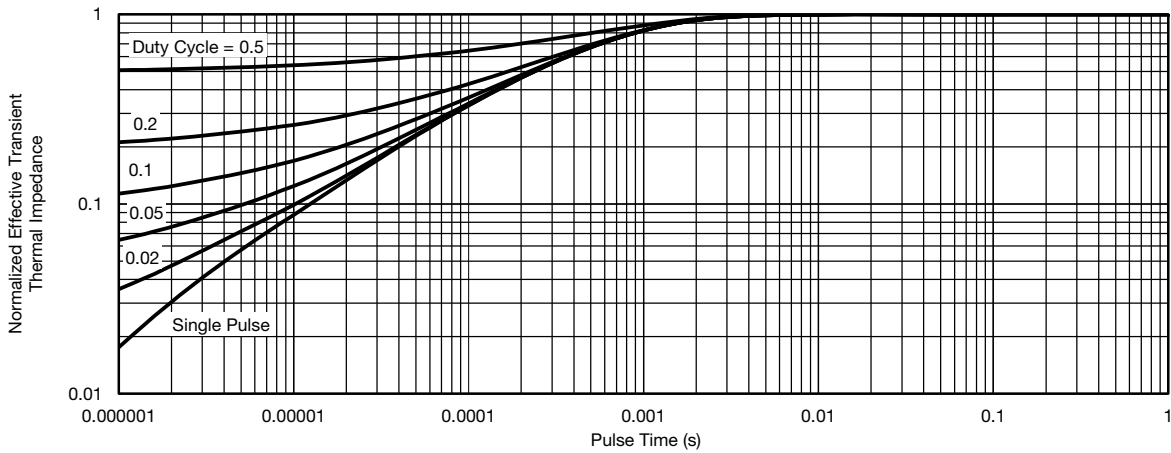

Fig. 12 - Normalized Thermal Transient Impedance, Junction-to-Case

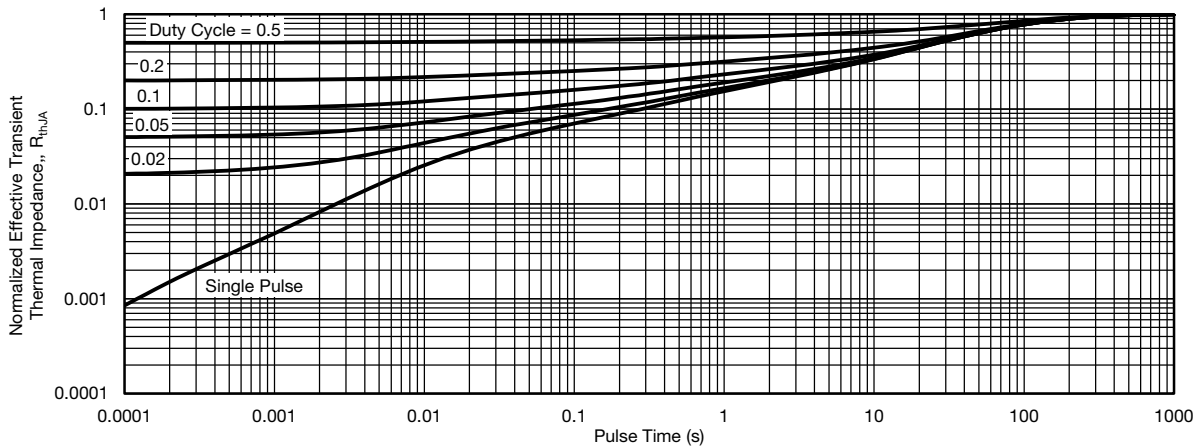

Fig. 13 - Normalized Thermal Transient Impedance, Junction-to-Ambient

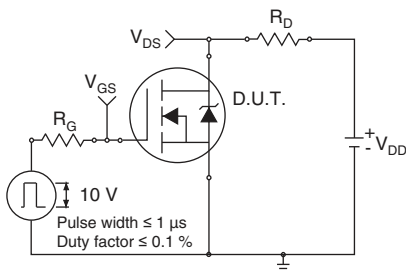

Fig. 14 - Switching Time Test Circuit

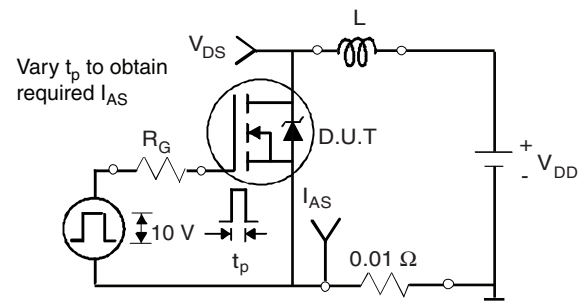

Fig. 16 - Unclamped Inductive Test Circuit

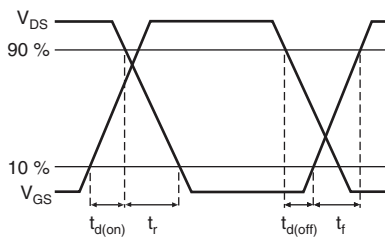

Fig. 15 - Switching Time Waveforms

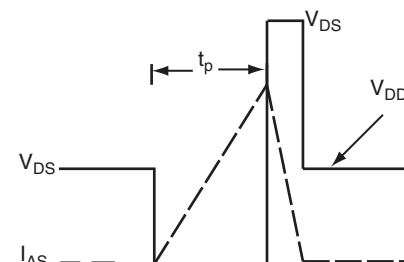

Fig. 17 - Unclamped Inductive Waveforms

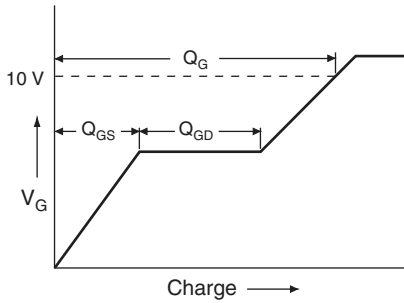

Fig. 18 - Basic Gate Charge Waveform

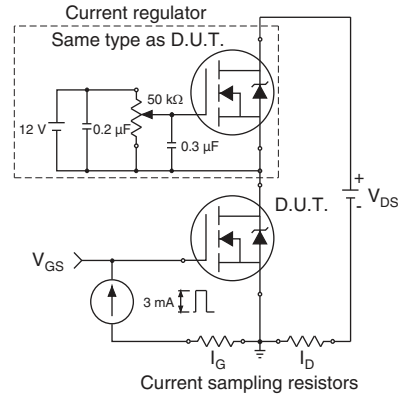
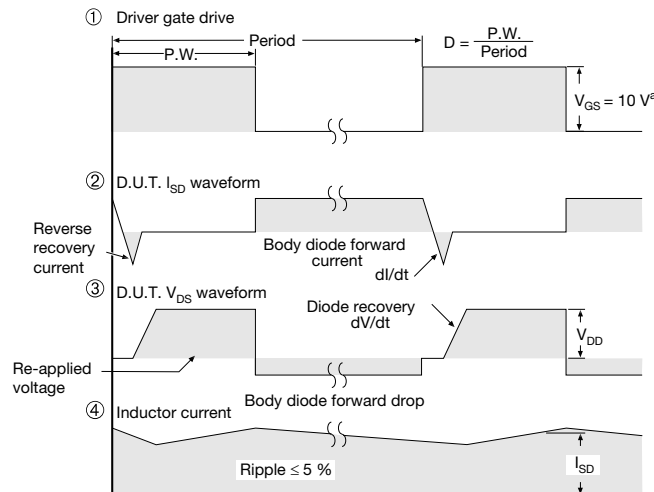
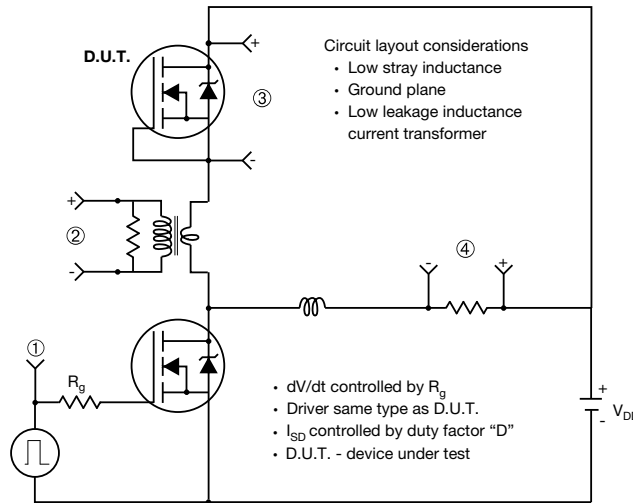

Fig. 19 - Gate Charge Test Circuit

Peak Diode Recovery dV/dt Test Circuit



Note
a. $V_{GS} = 5V$ for logic level devices

Fig. 20 - For N-Channel

Vishay Siliconix maintains worldwide manufacturing capability. Products may be manufactured at one of several qualified locations. Reliability data for Silicon Technology and Package Reliability represent a composite of all qualified locations. For related documents such as package/tape drawings, part marking, and reliability data, see www.vishay.com/ppg?91739.

PowerPAK® 8 x 8 Case Outline

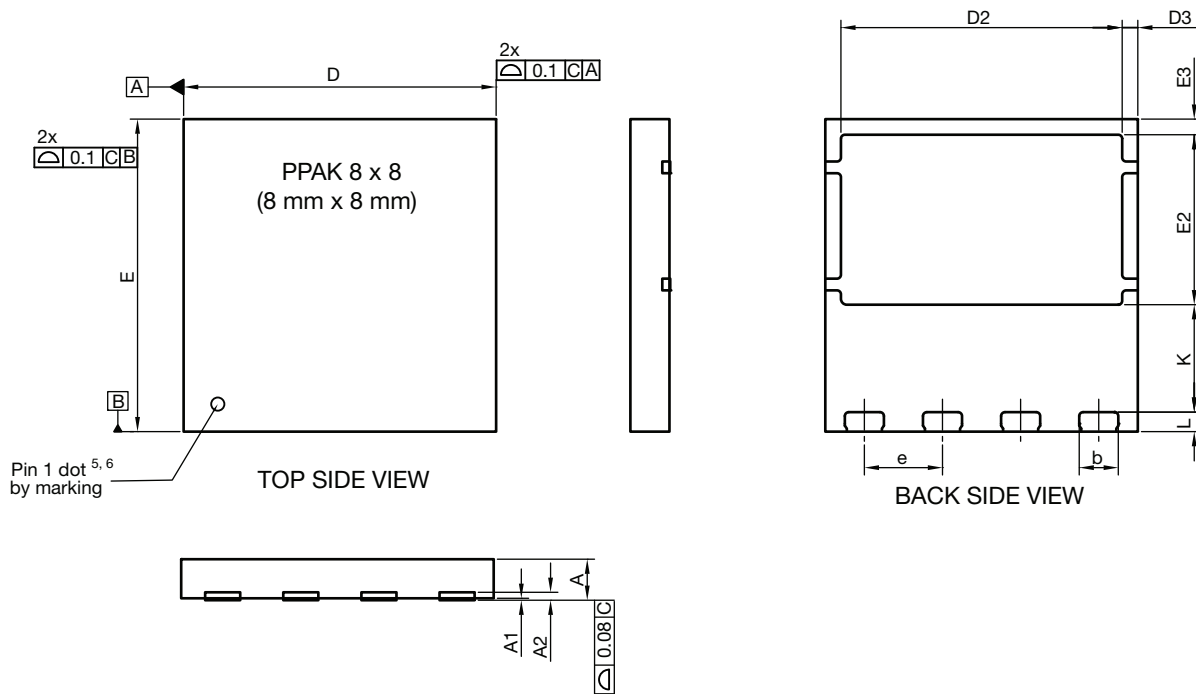

DIM.	MILLIMETERS			INCHES		
	MIN.	NOM.	MAX.	MIN.	NOM.	MAX.
A	0.95	1.00	1.05	0.037	0.039	0.041
A1	0.00	-	0.05	0.000	-	0.002
A2	020 ref.			0.008 ref.		
b	0.95	1.00	1.05	0.037	0.039	0.041
D	7.90	8.00	8.10	0.311	0.315	0.319
D2	7.10	7.20	7.30	0.280	0.283	0.287
D3	0.40 BSC			0.016 BSC		
e	2.00 BSC			0.079 BSC		
E	7.90	8.00	8.10	0.311	0.315	0.319
E2	4.30	4.35	4.40	0.169	0.171	0.173
E3	0.40 BSC			0.016 BSC		
K	2.75 BSC			0.108 BSC		
L	0.45	0.50	0.55	0.018	0.020	0.022
N ⁽³⁾	8			8		

Notes

- (1) Use millimeters as the primary measurement
- (2) Dimensioning and tolerances conform to ASME Y14.5 M - 1994
- (3) N is the number of terminals
- (4) The pin 1 identifier must be existed on the top surface of the package by using indentation mark or other feature of package body
- (5) Exact shape and size of this feature is optional

ECN: E20-0518-Rev. B, 28-Sep-2020
 DWG: 6041



Recommended Minimum PADs for PowerPAK[®] 8 mm x 8 mm

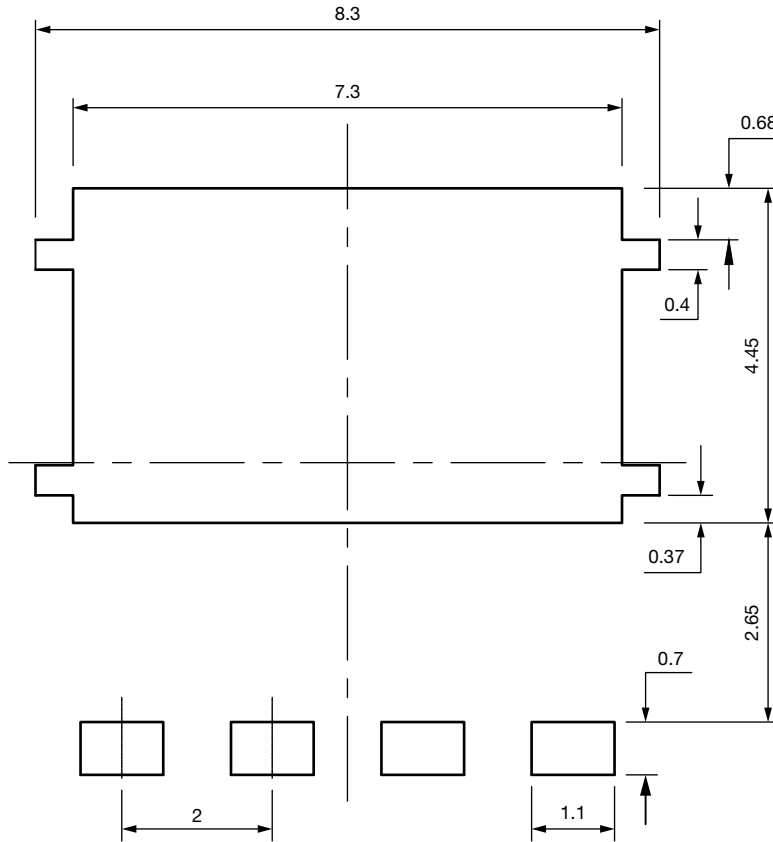

Dimensions in millimeters



Disclaimer

ALL PRODUCT, PRODUCT SPECIFICATIONS AND DATA ARE SUBJECT TO CHANGE WITHOUT NOTICE TO IMPROVE RELIABILITY, FUNCTION OR DESIGN OR OTHERWISE.

Vishay Intertechnology, Inc., its affiliates, agents, and employees, and all persons acting on its or their behalf (collectively, "Vishay"), disclaim any and all liability for any errors, inaccuracies or incompleteness contained in any datasheet or in any other disclosure relating to any product.

Vishay makes no warranty, representation or guarantee regarding the suitability of the products for any particular purpose or the continuing production of any product. To the maximum extent permitted by applicable law, Vishay disclaims (i) any and all liability arising out of the application or use of any product, (ii) any and all liability, including without limitation special, consequential or incidental damages, and (iii) any and all implied warranties, including warranties of fitness for particular purpose, non-infringement and merchantability.

Statements regarding the suitability of products for certain types of applications are based on Vishay's knowledge of typical requirements that are often placed on Vishay products in generic applications. Such statements are not binding statements about the suitability of products for a particular application. It is the customer's responsibility to validate that a particular product with the properties described in the product specification is suitable for use in a particular application. Parameters provided in datasheets and / or specifications may vary in different applications and performance may vary over time. All operating parameters, including typical parameters, must be validated for each customer application by the customer's technical experts. Product specifications do not expand or otherwise modify Vishay's terms and conditions of purchase, including but not limited to the warranty expressed therein.

Hyperlinks included in this datasheet may direct users to third-party websites. These links are provided as a convenience and for informational purposes only. Inclusion of these hyperlinks does not constitute an endorsement or an approval by Vishay of any of the products, services or opinions of the corporation, organization or individual associated with the third-party website. Vishay disclaims any and all liability and bears no responsibility for the accuracy, legality or content of the third-party website or for that of subsequent links.

Except as expressly indicated in writing, Vishay products are not designed for use in medical, life-saving, or life-sustaining applications or for any other application in which the failure of the Vishay product could result in personal injury or death. Customers using or selling Vishay products not expressly indicated for use in such applications do so at their own risk. Please contact authorized Vishay personnel to obtain written terms and conditions regarding products designed for such applications.

No license, express or implied, by estoppel or otherwise, to any intellectual property rights is granted by this document or by any conduct of Vishay. Product names and markings noted herein may be trademarks of their respective owners.