



Is Now Part of



**ON Semiconductor®**

To learn more about ON Semiconductor, please visit our website at

[www.onsemi.com](http://www.onsemi.com)

ON Semiconductor and the ON Semiconductor logo are trademarks of Semiconductor Components Industries, LLC dba ON Semiconductor or its subsidiaries in the United States and/or other countries. ON Semiconductor owns the rights to a number of patents, trademarks, copyrights, trade secrets, and other intellectual property. A listing of ON Semiconductor's product/patent coverage may be accessed at [www.onsemi.com/site/pdf/Patent-Marking.pdf](http://www.onsemi.com/site/pdf/Patent-Marking.pdf). ON Semiconductor reserves the right to make changes without further notice to any products herein. ON Semiconductor makes no warranty, representation or guarantee regarding the suitability of its products for any particular purpose, nor does ON Semiconductor assume any liability arising out of the application or use of any product or circuit, and specifically disclaims any and all liability, including without limitation special, consequential or incidental damages. Buyer is responsible for its products and applications using ON Semiconductor products, including compliance with all laws, regulations and safety requirements or standards, regardless of any support or applications information provided by ON Semiconductor. "Typical" parameters which may be provided in ON Semiconductor data sheets and/or specifications can and do vary in different applications and actual performance may vary over time. All operating parameters, including "Typicals" must be validated for each customer application by customer's technical experts. ON Semiconductor does not convey any license under its patent rights nor the rights of others. ON Semiconductor products are not designed, intended, or authorized for use as a critical component in life support systems or any FDA Class 3 medical devices or medical devices with a same or similar classification in a foreign jurisdiction or any devices intended for implantation in the human body. Should Buyer purchase or use ON Semiconductor products for any such unintended or unauthorized application, Buyer shall indemnify and hold ON Semiconductor and its officers, employees, subsidiaries, affiliates, and distributors harmless against all claims, costs, damages, and expenses, and reasonable attorney fees arising out of, directly or indirectly, any claim of personal injury or death associated with such unintended or unauthorized use, even if such claim alleges that ON Semiconductor was negligent regarding the design or manufacture of the part. ON Semiconductor is an Equal Opportunity/Affirmative Action Employer. This literature is subject to all applicable copyright laws and is not for resale in any manner.

**MPS5179**

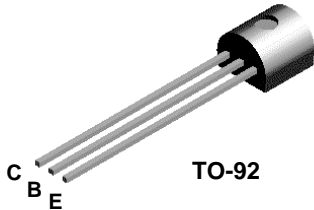

**MMBT5179**

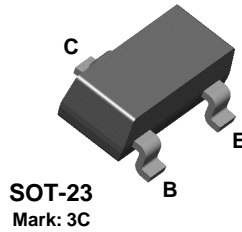

**PN5179**

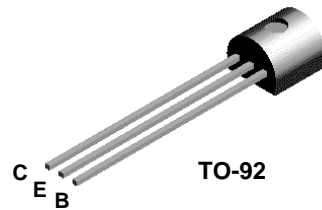

**NPN RF Transistor**

This device is designed for use in low noise UHF/VHF amplifiers with collector currents in the 100  $\mu$ A to 30 mA range in common emitter or common base mode of operation, and in low frequency drift, high output UHF oscillators. Sourced from Process 40.

**Absolute Maximum Ratings\***

TA = 25°C unless otherwise noted

| Symbol                            | Parameter  | Value       | Units |
|-----------------------------------|--|-------------|-------|
| V <sub>CEO</sub>                  | Collector-Emitter Voltage                        | 12          | V     |
| V <sub>CBO</sub>                  | Collector-Base Voltage                           | 20          | V     |
| V <sub>EBO</sub>                  | Emitter-Base Voltage                             | 2.5         | V     |
| I <sub>C</sub>                    | Collector Current - Continuous                   | 50          | mA    |
| T <sub>J</sub> , T <sub>stg</sub> | Operating and Storage Junction Temperature Range | -55 to +150 | °C    |

\*These ratings are limiting values above which the serviceability of any semiconductor device may be impaired.

**NOTES:**

- 1) These ratings are based on a maximum junction temperature of 150 degrees C.
- 2) These are steady state limits. The factory should be consulted on applications involving pulsed or low duty cycle operations.

**Thermal Characteristics**

TA = 25°C unless otherwise noted

| Symbol           | Characteristic                                | Max        |           | Units |
|------------------|---|------------|-----------|-------|
|                  |   | PN/MPS5179 | *MMBT5179 |       |
| P <sub>D</sub>   | Total Device Dissipation<br>Derate above 25°C | 350        | 225       | mW    |
|                  |   | 2.8        | 1.8       | mW/°C |
| R <sub>θJA</sub> | Thermal Resistance, Junction to Ambient       | 357        | 556       | °C/W  |

\* Device mounted on FR-4 PCB 1.6" X 1.6" X 0.06."

**NPN RF Transistor**  
(continued)

**MPS5179 / MMBT5179 / PN5179**

**Electrical Characteristics**

TA = 25°C unless otherwise noted

| Symbol | Parameter | Test Conditions | Min | Max | Units |
|--------|-----------|-----------------|-----|-----|-------|
|--------|-----------|-----------------|-----|-----|-------|

**OFF CHARACTERISTICS**

|                |                                       |  |     |             |                                |
|----------------|---------------------------------------|--|-----|-------------|--------------------------------|
| $V_{CEO(sus)}$ | Collector-Emitter Sustaining Voltage* | $I_C = 3.0 \text{ mA}, I_B = 0$  | 12  |             | V                              |
| $V_{(BR)CBO}$  | Collector-Base Breakdown Voltage      | $I_C = 1.0 \mu\text{A}, I_E = 0$   | 20  |             | V                              |
| $V_{(BR)EBO}$  | Emitter-Base Breakdown Voltage        | $I_E = 10 \mu\text{A}, I_C = 0$  | 2.5 |             | V                              |
| $I_{CBO}$      | Collector Cutoff Current              | $V_{CB} = 15 \text{ V}, I_E = 0$<br>$V_{CB} = 15 \text{ V}, T_A = 150^\circ\text{C}$ |     | 0.02<br>1.0 | $\mu\text{A}$<br>$\mu\text{A}$ |

**ON CHARACTERISTICS**

|               |                                      |  |    |     |   |
|---------------|--------------------------------------|--|----|-----|---|
| $h_{FE}$      | DC Current Gain                      | $I_C = 3.0 \text{ mA}, V_{CE} = 1.0 \text{ V}$ | 25 | 250 |   |
| $V_{CE(sat)}$ | Collector-Emitter Saturation Voltage | $I_C = 10 \text{ mA}, I_B = 1.0 \text{ mA}$    |    | 0.4 | V |
| $V_{BE(sat)}$ | Base-Emitter Saturation Voltage      | $I_C = 10 \text{ mA}, I_B = 1.0 \text{ mA}$    |    | 1.0 | V |

**SMALL SIGNAL CHARACTERISTICS**

|           |                                  |  |     |      |     |
|-----------|----------------------------------|--|-----|------|-----|
| $f_T$     | Current Gain - Bandwidth Product | $I_C = 5.0 \text{ mA}, V_{CE} = 6.0 \text{ V},$<br>$f = 100 \text{ MHz}$                 | 900 | 2000 | MHz |
| $C_{cb}$  | Collector-Base Capacitance       | $V_{CB} = 10 \text{ V}, I_E = 0,$<br>$f = 0.1 \text{ to } 1.0 \text{ MHz}$               |     | 1.0  | pF  |
| $h_{fe}$  | Small-Signal Current Gain        | $I_C = 2.0 \text{ mA}, V_{CE} = 6.0 \text{ V},$<br>$f = 1.0 \text{ kHz}$                 | 25  | 300  |     |
| $r_b'C_c$ | Collector Base Time Constant     | $I_C = 2.0 \text{ mA}, V_{CB} = 6.0 \text{ V},$<br>$f = 31.9 \text{ MHz}$                | 3.0 | 14   | ps  |
| NF        | Noise Figure                     | $I_C = 1.5 \text{ mA}, V_{CE} = 6.0 \text{ V},$<br>$R_S = 50\Omega, f = 200 \text{ MHz}$ |     | 5.0  | dB  |

**FUNCTIONAL TEST**

|          |                      |   |    |  |    |
|----------|----------------------|---|----|--|----|
| $G_{pe}$ | Amplifier Power Gain | $V_{CE} = 6.0 \text{ V}, I_C = 5.0 \text{ mA},$<br>$f = 200 \text{ MHz}$  | 15 |  | dB |
| $P_O$    | Power Output         | $V_{CB} = 10 \text{ V}, I_E = 12 \text{ mA},$<br>$f \geq 500 \text{ MHz}$ | 20 |  | mW |

\*Pulse Test: Pulse Width  $\leq 300 \mu\text{s}$ , Duty Cycle  $\leq 2.0\%$

**Spice Model**

NPN (Is=69.28E-18 Xti=3 Eg=1.11 Vaf=100 Bf=282.1 Ne=1.177 Ise=69.28E-18 Ikf=22.03m Xtb=1.5 Br=1.176 Nc=2 Isc=0 Ikr=0 Rc=4 Cjc=1.042p Mjc=.2468 Vjc=.75 Fc=.5 Cje=1.52p Mje=.3223 Vje=.75 Tr=1.588n Tf=135.6p Itf=.27 Vtf=10 Xtf=30 Rb=10)

Typical Characteristics

DC Current Gain vs Collector Current

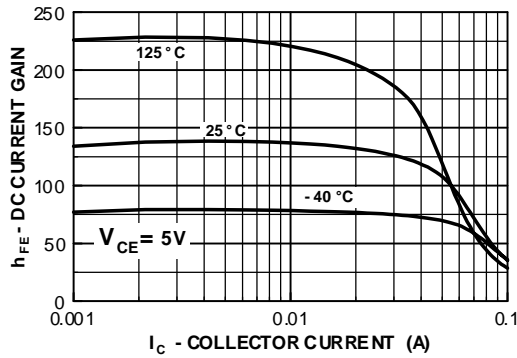

Collector-Emitter Saturation Voltage vs Collector Current

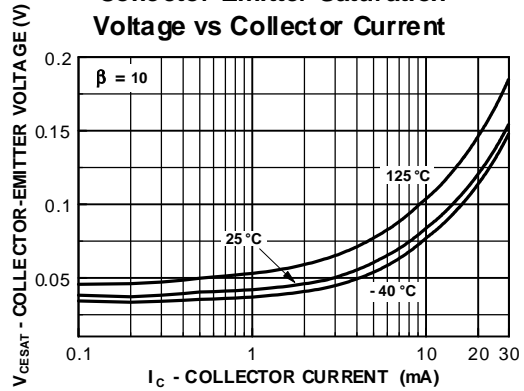

Base-Emitter Saturation Voltage vs Collector Current

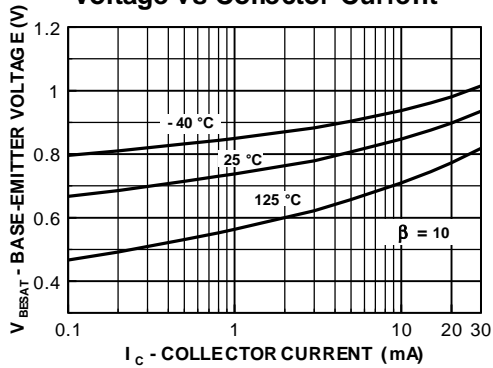

Base-Emitter ON Voltage vs Collector Current

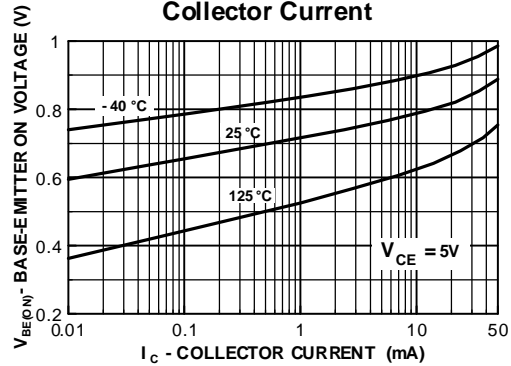

Collector-Cutoff Current vs Ambient Temperature

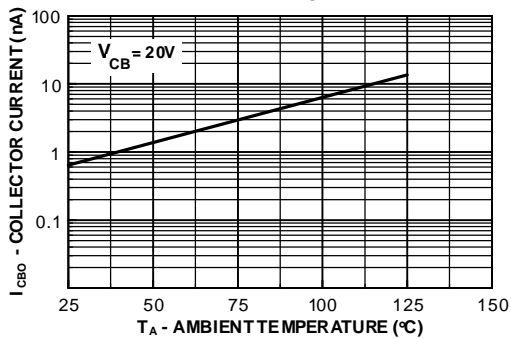

Power Dissipation vs Ambient Temperature

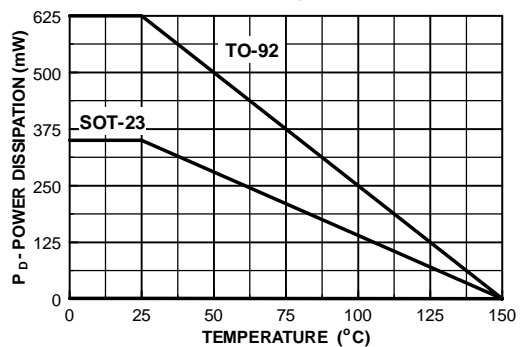

Test Circuit

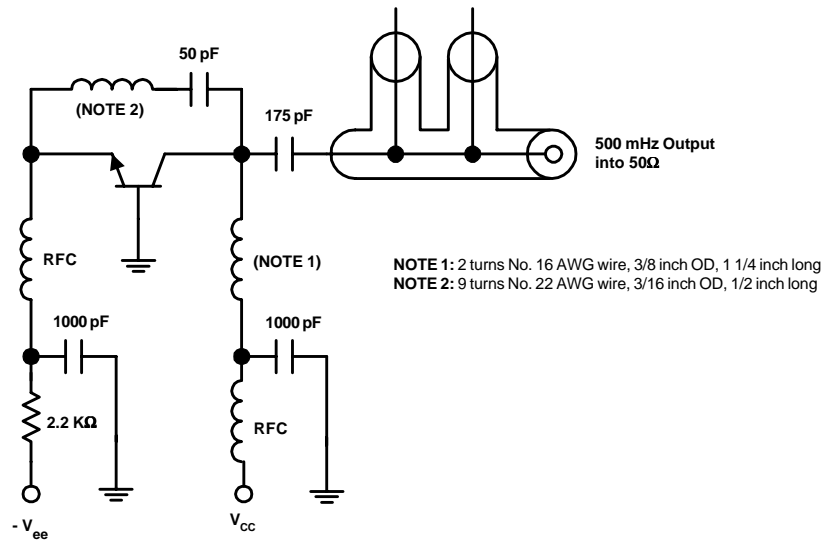

FIGURE 1: 500 MHz Oscillator Circuit

# TO-92 Tape and Reel Data



## TO-92 Packaging Configuration: Figure 1.0

FSCINT Label sample

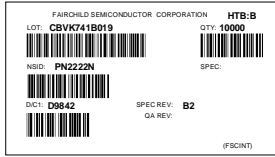

F63TNR Label sample

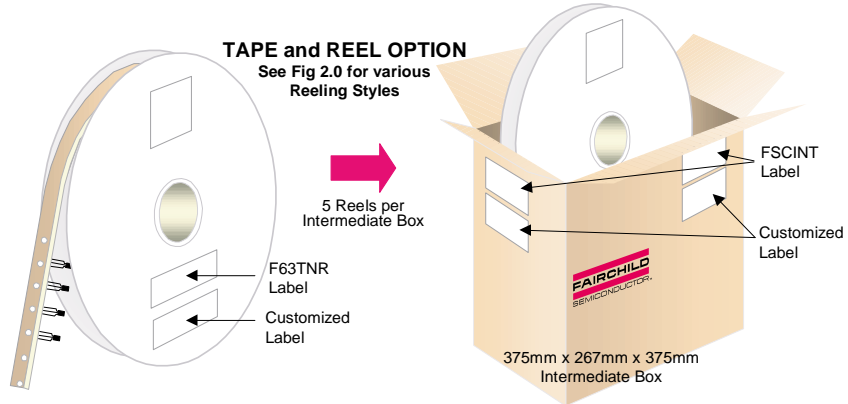

### TO-92 TNR/AMMO PACKING INFORMATION

| Packing | Style | Quantity | EOL code |
|---------|-------|----------|----------|
| Reel    | A     | 2,000    | D26Z     |
|         | E     | 2,000    | D27Z     |
| Ammo    | M     | 2,000    | D74Z     |
|         | P     | 2,000    | D75Z     |

Unit weight = 0.22 gm  
 Reel weight with components = 1.04 kg  
 Ammo weight with components = 1.02 kg  
 Max quantity per intermediate box = 10,000 units

### AMMO PACK OPTION

See Fig 3.0 for 2 Ammo Pack Options

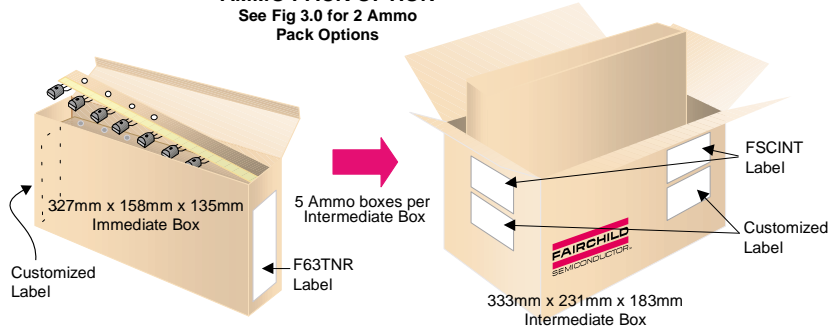

### (TO-92) BULK PACKING INFORMATION

| EOL CODE    | DESCRIPTION   | LEADCLIP DIMENSION | QUANTITY    |
|-------------|---|--------------------|-------------|
| J18Z        | TO-18 OPTION STD  | NO LEAD CLIP       | 2.0 K / BOX |
| J05Z        | TO-5 OPTION STD   | NO LEAD CLIP       | 1.5 K / BOX |
| NO EOL CODE | TO-92 STANDARD STRAIGHT FOR: PKG 92, 94 (NON PROELECTRON SERIES), 96                  | NO LEADCLIP        | 2.0 K / BOX |
| L34Z        | TO-92 STANDARD STRAIGHT FOR: PKG 94 (PROELECTRON SERIES BCXXX, BFXXX, BSRXXX), 97, 98 | NO LEADCLIP        | 2.0 K / BOX |

### BULK OPTION

See Bulk Packing Information table

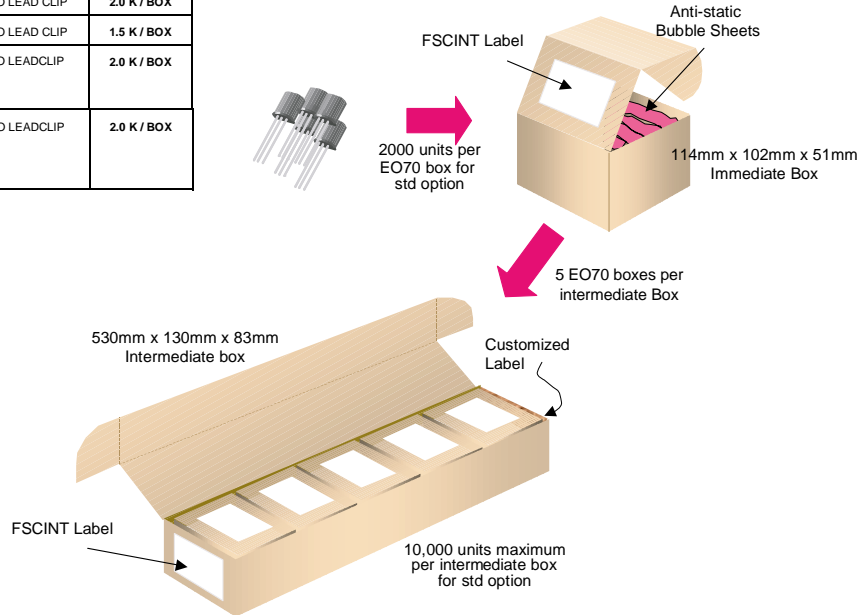

## TO-92 Tape and Reel Data, continued

### TO-92 Reeling Style

Configuration: Figure 2.0

#### Machine Option "A" (H)

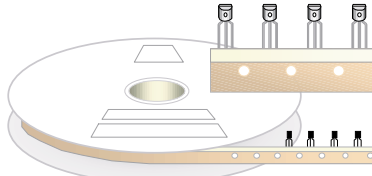

Style "A", D26Z, D70Z (s/h)

#### Machine Option "E" (J)

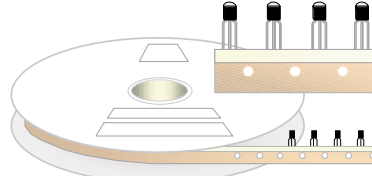

Style "E", D27Z, D71Z (s/h)

### TO-92 Radial Ammo Packaging

Configuration: Figure 3.0

FIRST WIRE OFF IS COLLECTOR  
ADHESIVE TAPE IS ON THE TOP SIDE  
FLAT OF TRANSISTOR IS ON TOP

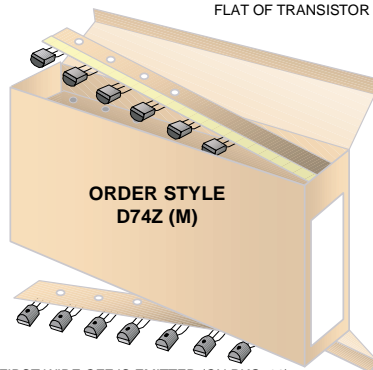

ORDER STYLE  
D74Z (M)

FIRST WIRE OFF IS EMITTER (ON PKG. 92)  
ADHESIVE TAPE IS ON BOTTOM SIDE  
FLAT OF TRANSISTOR IS ON BOTTOM

FIRST WIRE OFF IS EMITTER  
ADHESIVE TAPE IS ON THE TOP SIDE  
FLAT OF TRANSISTOR IS ON BOTTOM

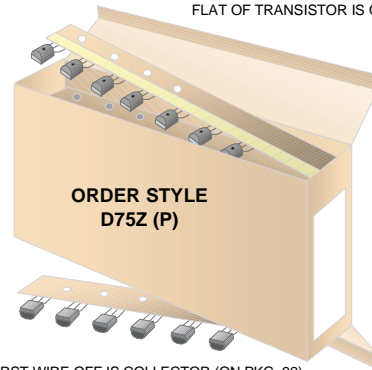

ORDER STYLE  
D75Z (P)

FIRST WIRE OFF IS COLLECTOR (ON PKG. 92)  
ADHESIVE TAPE IS ON BOTTOM SIDE  
FLAT OF TRANSISTOR IS ON TOP

# TO-92 Tape and Reel Data, continued

**TO-92 Tape and Reel Taping  
Dimension Configuration: Figure 4.0**

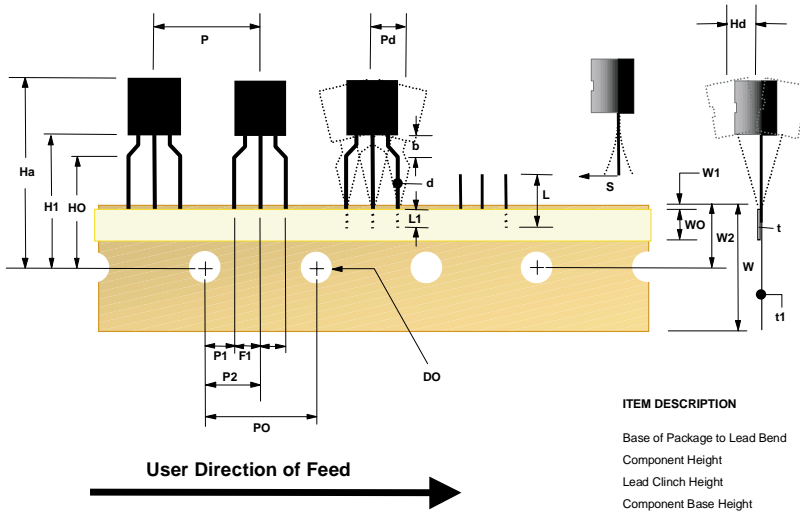

| ITEM DESCRIPTION                   | SYMBOL | DIMENSION              |
|------------------------------------|--------|------------------------|
| Base of Package to Lead Bend       | b      | 0.098 (max)            |
| Component Height                   | Ha     | 0.928 (+/- 0.025)      |
| Lead Clinch Height                 | HO     | 0.630 (+/- 0.020)      |
| Component Base Height              | H1     | 0.748 (+/- 0.020)      |
| Component Alignment ( side/side )  | Pd     | 0.040 (max)            |
| Component Alignment ( front/back ) | Hd     | 0.031 (max)            |
| Component Pitch                    | P      | 0.500 (+/- 0.020)      |
| Feed Hole Pitch                    | PO     | 0.500 (+/- 0.008)      |
| Hole Center to First Lead          | P1     | 0.150 (+0.009, -0.010) |
| Hole Center to Component Center    | P2     | 0.247 (+/- 0.007)      |
| Lead Spread                        | F1/F2  | 0.104 (+/- 0.010)      |
| Lead Thickness                     | d      | 0.018 (+0.002, -0.003) |
| Cut Lead Length                    | L      | 0.429 (max)            |
| Taped Lead Length                  | L1     | 0.209 (+0.051, -0.052) |
| Taped Lead Thickness               | t      | 0.032 (+/- 0.006)      |
| Carrier Tape Thickness             | t1     | 0.021 (+/- 0.006)      |
| Carrier Tape Width                 | W      | 0.708 (+0.020, -0.019) |
| Hold - down Tape Width             | WO     | 0.236 (+/- 0.012)      |
| Hold - down Tape position          | W1     | 0.035 (max)            |
| Feed Hole Position                 | W2     | 0.360 (+/- 0.025)      |
| Sprocket Hole Diameter             | DO     | 0.157 (+0.008, -0.007) |
| Lead Spring Out                    | S      | 0.004 (max)            |

Note : All dimensions are in inches.

**TO-92 Reel  
Configuration: Figure 5.0**

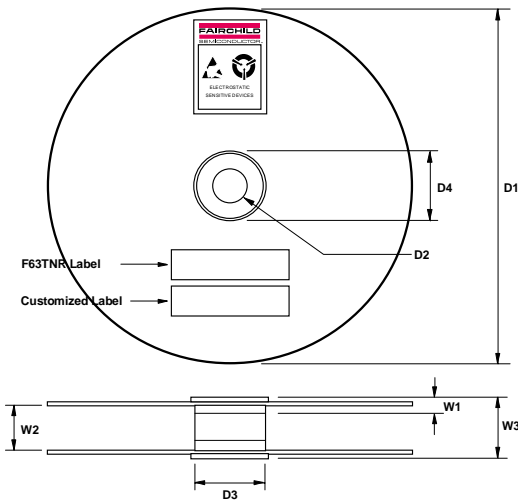

| ITEM DESCRIPTION               | SYMBOL | MINIMUM | MAXIMUM |
|--------------------------------|--------|---------|---------|
| Reel Diameter                  | D1     | 13.975  | 14.025  |
| Arbor Hole Diameter (Standard) | D2     | 1.160   | 1.200   |
| (Small Hole)                   | D2     | 0.650   | 0.700   |
| Core Diameter                  | D3     | 3.100   | 3.300   |
| Hub Recess Inner Diameter      | D4     | 2.700   | 3.100   |
| Hub Recess Depth               | W1     | 0.370   | 0.570   |
| Flange to Flange Inner Width   | W2     | 1.630   | 1.690   |
| Hub to Hub Center Width        | W3     |         | 2.090   |

Note: All dimensions are in inches



# TO-92 Package Dimensions



## TO-92 (FS PKG Code 92, 94, 96)

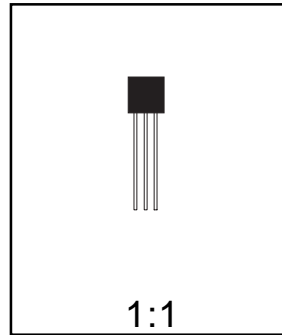
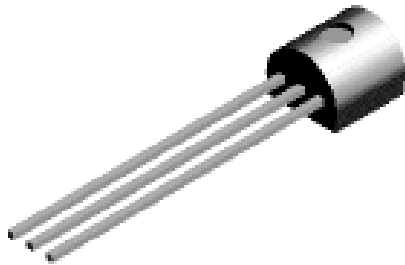

Scale 1:1 on letter size paper

Dimensions shown below are in:  
inches [millimeters]

Part Weight per unit (gram): 0.1977

TO-92 (92,94,96)

| PIN | 92 |   | 94 |   | 96 |   |
|-----|----|---|----|---|----|---|
|     | B  | F | B  | F | B  | F |
| 1   | E  | D | E  | D | B  | S |
| 2   | B  | S | C  | G | E  | D |
| 3   | C  | G | B  | S | C  | G |

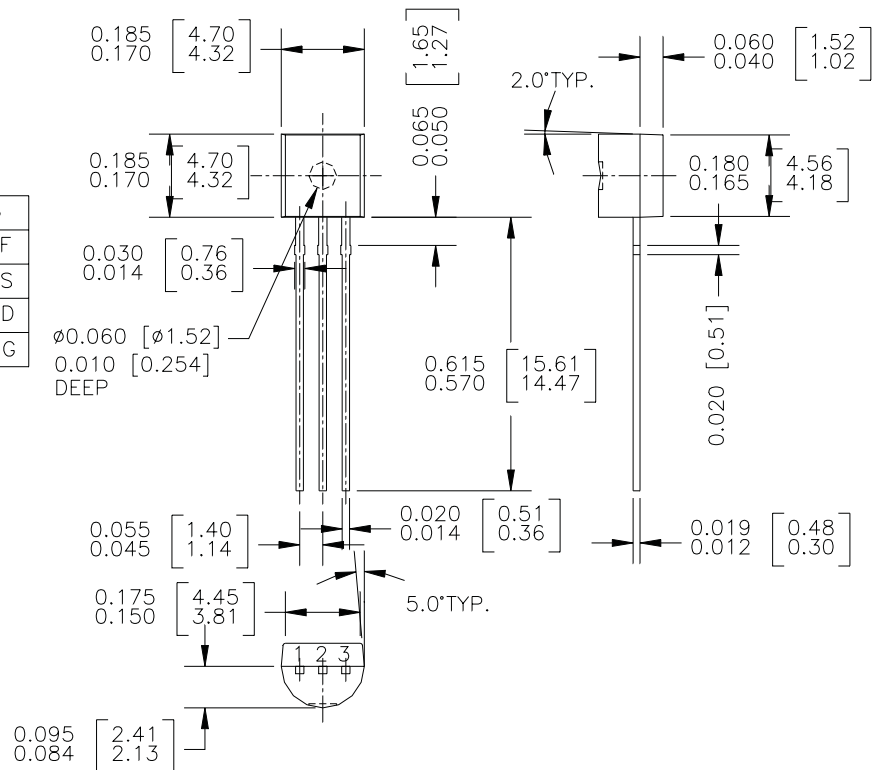

# SOT-23 Tape and Reel Data



## SOT-23 Packaging Configuration: Figure 10

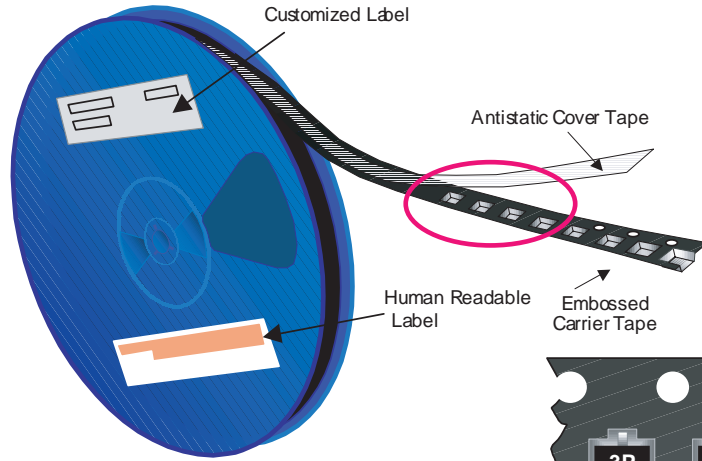

### Packaging Description:

SOT-23 parts are shipped in tape. The carrier tape is made from a dissipative (carbon filled) polycarbonate resin. The cover tape is a multilayer film (Heat Activated Adhesive in nature) primarily composed of polyester film, adhesive layer, sealant, and anti-static sprayed agent. These reeled parts in standard option are shipped with 3,000 units per 7" or 177mm diameter reel. The reels are dark blue in color and is made of polystyrene plastic (anti-static coated). Other option comes in 10,000 units per 13" or 330mm diameter reel. This and some other options are described in the Packaging Information table.

These full reels are individually labeled and placed inside a standard intermediate made of recyclable corrugated brown paper with a Fairchild logo printing. One pizza box contains eight reels maximum. And these intermediate boxes are placed inside a labeled shipping box which comes in different sizes depending on the number of parts shipped.

| SOT-23 Packaging Information |                         |            |
|------------------------------|-------------------------|------------|
| Packaging Option             | Standard (no flow code) | D87Z       |
| Packaging type               | TNR                     | TNR        |
| Qty per Reel/Tube/Bag        | 3,000                   | 10,000     |
| Reel Size                    | 7" Dia                  | 13"        |
| Box Dimension (mm)           | 187x107x183             | 343x343x64 |
| Max qty per Box              | 24,000                  | 30,000     |
| Weight per unit (gm)         | 0.0082                  | 0.0082     |
| Weight per Reel (kg)         | 0.1175                  | 0.4006     |
| Note/Comments                |                         |            |

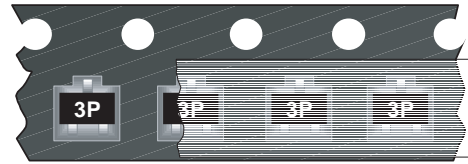

### SOT-23 Unit Orientation

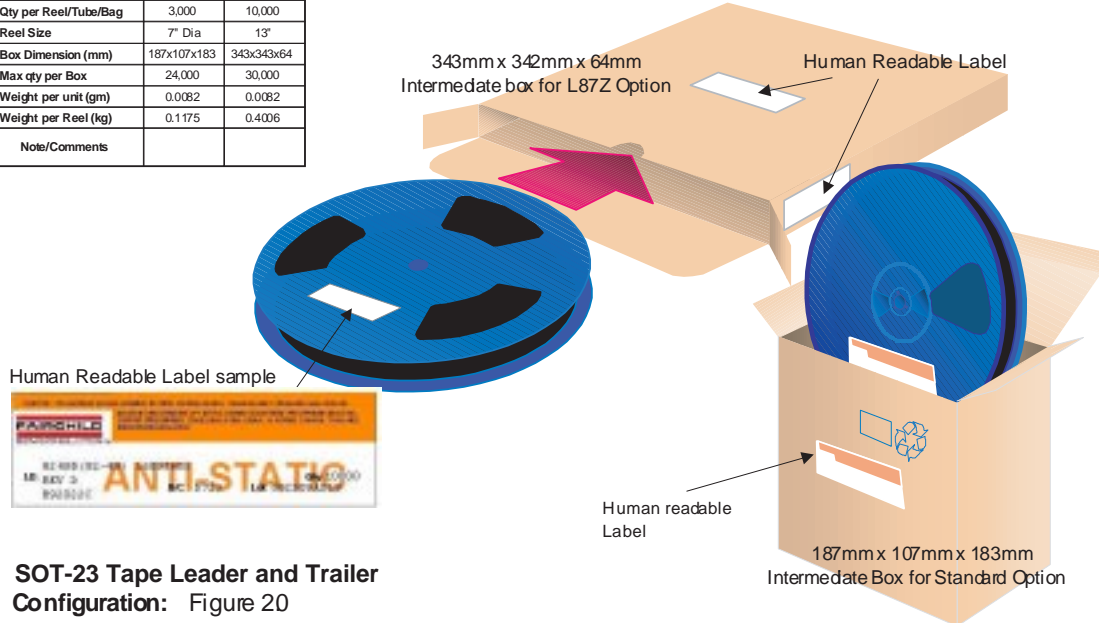

Human Readable Label sample



## SOT-23 Tape Leader and Trailer Configuration: Figure 20

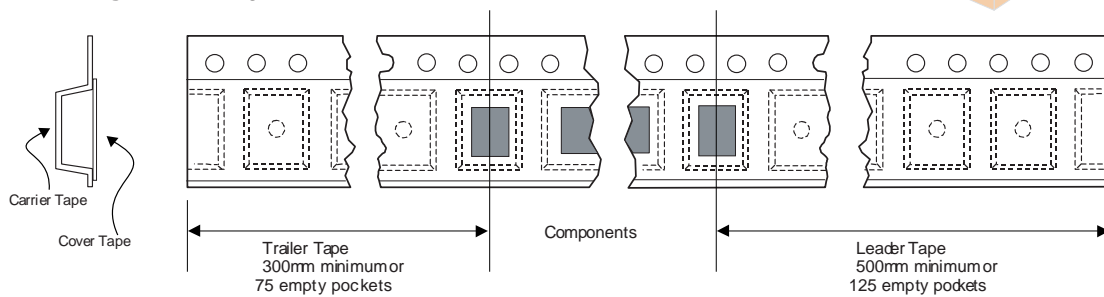

# SOT-23 Tape and Reel Data, continued

## SOT-23 Embossed Carrier Tape Configuration: Figure 3.0

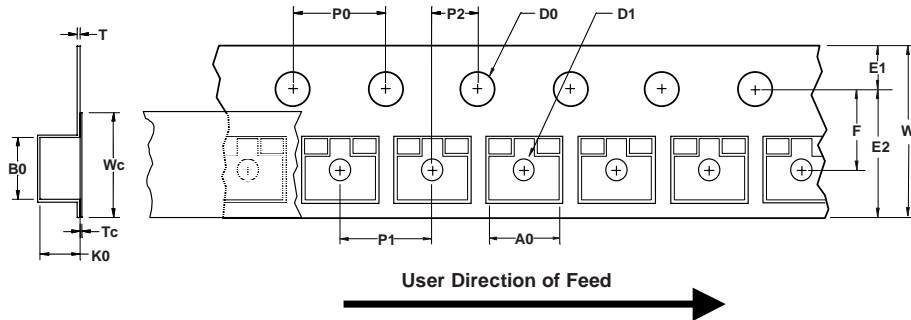

Dimensions are in millimeter

| Pkg type     | A0            | B0            | W           | D0            | D1              | E1            | E2          | F             | P1          | P0          | K0            | T               | Wc          | Tc            |
|--------------|---------------|---------------|-------------|---------------|-----------------|---------------|-------------|---------------|-------------|-------------|---------------|-----------------|-------------|---------------|
| SOT-23 (8mm) | 3.15<br>±0.10 | 2.77<br>±0.10 | 8.0<br>±0.3 | 1.55<br>±0.05 | 1.125<br>±0.125 | 1.75<br>±0.10 | 6.25<br>min | 3.50<br>±0.05 | 4.0<br>±0.1 | 4.0<br>±0.1 | 1.30<br>±0.10 | 0.228<br>±0.013 | 5.2<br>±0.3 | 0.06<br>±0.02 |

Notes: A0, B0, and K0 dimensions are determined with respect to the EIA/Jedec RS-481 rotational and lateral movement requirements (see sketches A, B, and C).

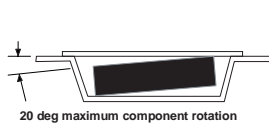

Sketch A (Side or Front Sectional View)  
Component Rotation

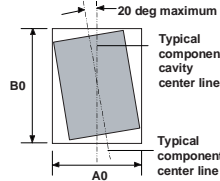

Sketch B (Top View)  
Component Rotation

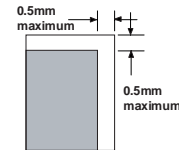

Sketch C (Top View)  
Component lateral movement

## SOT-23 Reel Configuration: Figure 4.0

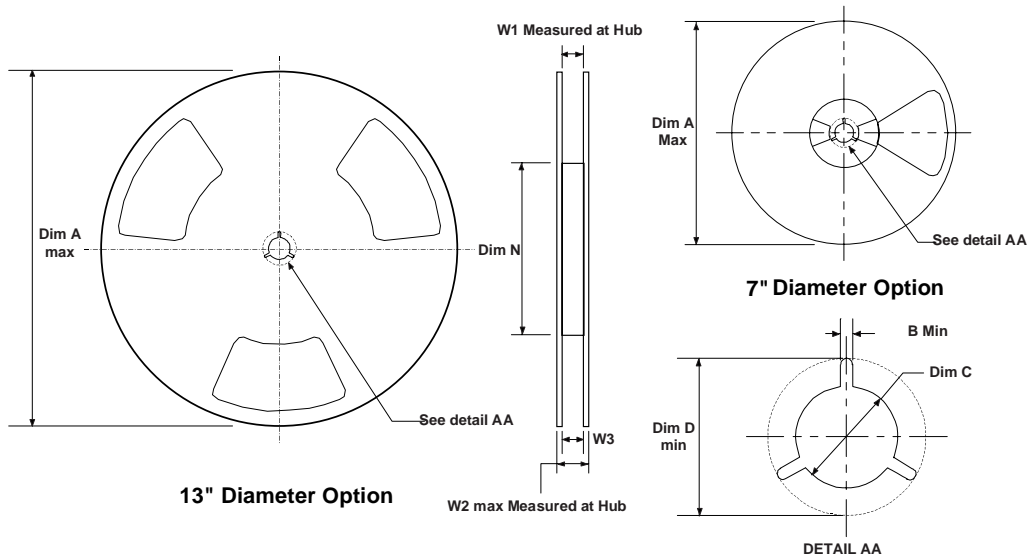

Dimensions are in inches and millimeters

| Tape Size | Reel Option | Dim A         | Dim B        | Dim C                             | Dim D         | Dim N       | Dim W1                            | Dim W2        | Dim W3 (LSL-USL)           |
|-----------|-------------|---------------|--------------|-----------------------------------|---------------|-------------|-----------------------------------|---------------|----------------------------|
| 8mm       | 7" Dia      | 7.00<br>177.8 | 0.059<br>1.5 | 512 +0.020/-0.008<br>13 +0.5/-0.2 | 0.795<br>20.2 | 2.165<br>55 | 0.331 +0.059/-0.000<br>8.4 +1.5/0 | 0.567<br>14.4 | 0.311 -0.429<br>7.9 - 10.9 |
| 8mm       | 13" Dia     | 13.00<br>330  | 0.059<br>1.5 | 512 +0.020/-0.008<br>13 +0.5/-0.2 | 0.795<br>20.2 | 4.00<br>100 | 0.331 +0.059/-0.000<br>8.4 +1.5/0 | 0.567<br>14.4 | 0.311 -0.429<br>7.9 - 10.9 |

# SOT-23 Package Dimensions



## SOT-23 (FS PKG Code 49)

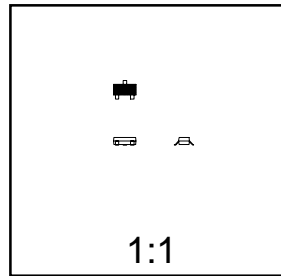
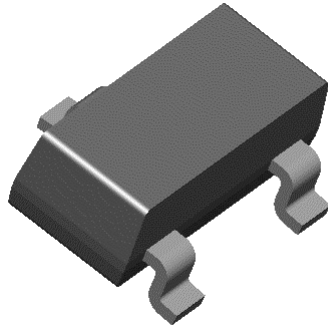

Scale 1:1 on letter size paper

Dimensions shown below are in:  
inches [millimeters]

Part Weight per unit (gram): 0.0082

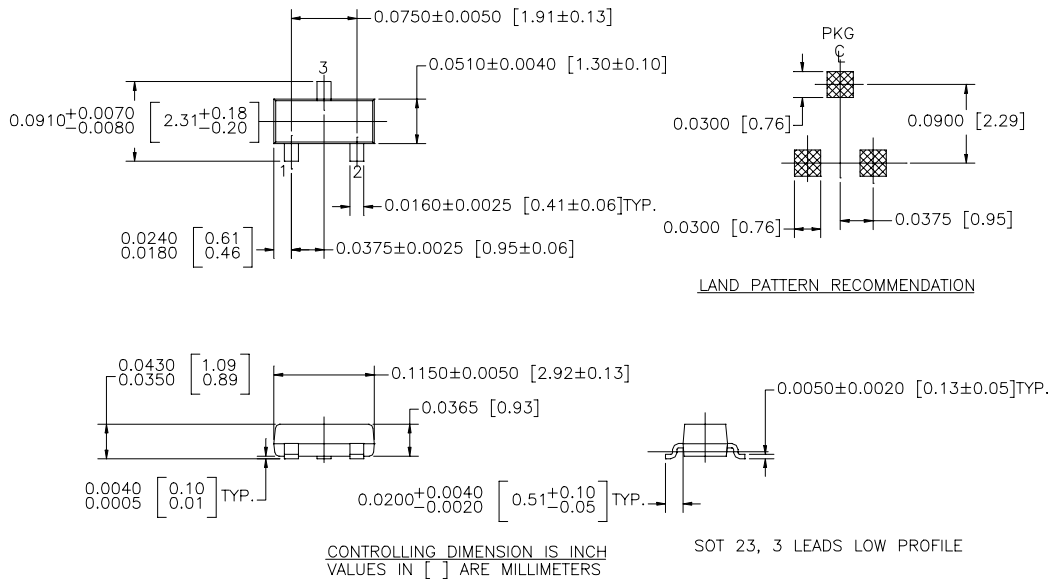

NOTE : UNLESS OTHERWISE SPECIFIED

- STANDARD LEAD FINISH 150 MICRONS / 3.81 MICROMETERS  
MINIMUM TIN / LEAD (SOLDER) ON ALLOY 42
- REFERENCE JEDEC REGISTRATION TO-236, VARIATION AB, ISSUE G, DATED JUL 1993

## TRADEMARKS

The following are registered and unregistered trademarks Fairchild Semiconductor owns or is authorized to use and is not intended to be an exhaustive list of all such trademarks.

|                                   |                                      |                                  |                         |
|-----------------------------------|--------------------------------------|----------------------------------|-------------------------|
| ACE <sup>x</sup> <sup>TM</sup>    | FAST <sup>r</sup> <sup>TM</sup>      | PowerTrench <sup>®</sup>         | SyncFET <sup>TM</sup>   |
| Bottomless <sup>TM</sup>          | GlobalOptoisolator <sup>TM</sup>     | QFET <sup>TM</sup>               | TinyLogic <sup>TM</sup> |
| CoolFET <sup>TM</sup>             | GTO <sup>TM</sup>                    | QS <sup>TM</sup>                 | UHC <sup>TM</sup>       |
| CROSSVOLT <sup>TM</sup>           | HiSeC <sup>TM</sup>                  | QT Optoelectronics <sup>TM</sup> | VCX <sup>TM</sup>       |
| DO <sup>M</sup> E <sup>TM</sup>   | ISOP <sup>L</sup> ANAR <sup>TM</sup> | Quiet Series <sup>TM</sup>       |                         |
| E <sup>2</sup> CMOS <sup>TM</sup> | MICROWIRE <sup>TM</sup>              | SILENT SWITCHER <sup>®</sup>     |                         |
| EnSigna <sup>TM</sup>             | OPTOLOGIC <sup>TM</sup>              | SMART START <sup>TM</sup>        |                         |
| FACT <sup>TM</sup>                | OPTOPLANAR <sup>TM</sup>             | SuperSOT <sup>TM</sup> -3        |                         |
| FACT Quiet Series <sup>TM</sup>   | PACMAN <sup>TM</sup>                 | SuperSOT <sup>TM</sup> -6        |                         |
| FAST <sup>®</sup>                 | POP <sup>TM</sup>                    | SuperSOT <sup>TM</sup> -8        |                         |

## DISCLAIMER

FAIRCHILD SEMICONDUCTOR RESERVES THE RIGHT TO MAKE CHANGES WITHOUT FURTHER NOTICE TO ANY PRODUCTS HEREIN TO IMPROVE RELIABILITY, FUNCTION OR DESIGN. FAIRCHILD DOES NOT ASSUME ANY LIABILITY ARISING OUT OF THE APPLICATION OR USE OF ANY PRODUCT OR CIRCUIT DESCRIBED HEREIN; NEITHER DOES IT CONVEY ANY LICENSE UNDER ITS PATENT RIGHTS, NOR THE RIGHTS OF OTHERS.

## LIFE SUPPORT POLICY

FAIRCHILD'S PRODUCTS ARE NOT AUTHORIZED FOR USE AS CRITICAL COMPONENTS IN LIFE SUPPORT DEVICES OR SYSTEMS WITHOUT THE EXPRESS WRITTEN APPROVAL OF FAIRCHILD SEMICONDUCTOR CORPORATION. As used herein:

1. Life support devices or systems are devices or systems which, (a) are intended for surgical implant into the body, or (b) support or sustain life, or (c) whose failure to perform when properly used in accordance with instructions for use provided in the labeling, can be reasonably expected to result in significant injury to the user.
2. A critical component is any component of a life support device or system whose failure to perform can be reasonably expected to cause the failure of the life support device or system, or to affect its safety or effectiveness.

## PRODUCT STATUS DEFINITIONS

### Definition of Terms

| Datasheet Identification | Product Status         | Definition  |
|--------------------------|------------------------|---|
| Advance Information      | Formative or In Design | This datasheet contains the design specifications for product development. Specifications may change in any manner without notice.  |
| Preliminary              | First Production       | This datasheet contains preliminary data, and supplementary data will be published at a later date. Fairchild Semiconductor reserves the right to make changes at any time without notice in order to improve design. |
| No Identification Needed | Full Production        | This datasheet contains final specifications. Fairchild Semiconductor reserves the right to make changes at any time without notice in order to improve design.   |
| Obsolete                 | Not In Production      | This datasheet contains specifications on a product that has been discontinued by Fairchild semiconductor. The datasheet is printed for reference information only.   |

ON Semiconductor and  are trademarks of Semiconductor Components Industries, LLC dba ON Semiconductor or its subsidiaries in the United States and/or other countries. ON Semiconductor owns the rights to a number of patents, trademarks, copyrights, trade secrets, and other intellectual property. A listing of ON Semiconductor's product/patent coverage may be accessed at [www.onsemi.com/site/pdf/Patent-Marking.pdf](http://www.onsemi.com/site/pdf/Patent-Marking.pdf). ON Semiconductor reserves the right to make changes without further notice to any products herein. ON Semiconductor makes no warranty, representation or guarantee regarding the suitability of its products for any particular purpose, nor does ON Semiconductor assume any liability arising out of the application or use of any product or circuit, and specifically disclaims any and all liability, including without limitation special, consequential or incidental damages. Buyer is responsible for its products and applications using ON Semiconductor products, including compliance with all laws, regulations and safety requirements or standards, regardless of any support or applications information provided by ON Semiconductor. "Typical" parameters which may be provided in ON Semiconductor data sheets and/or specifications can and do vary in different applications and actual performance may vary over time. All operating parameters, including "Typicals" must be validated for each customer application by customer's technical experts. ON Semiconductor does not convey any license under its patent rights nor the rights of others. ON Semiconductor products are not designed, intended, or authorized for use as a critical component in life support systems or any FDA Class 3 medical devices or medical devices with a same or similar classification in a foreign jurisdiction or any devices intended for implantation in the human body. Should Buyer purchase or use ON Semiconductor products for any such unintended or unauthorized application, Buyer shall indemnify and hold ON Semiconductor and its officers, employees, subsidiaries, affiliates, and distributors harmless against all claims, costs, damages, and expenses, and reasonable attorney fees arising out of, directly or indirectly, any claim of personal injury or death associated with such unintended or unauthorized use, even if such claim alleges that ON Semiconductor was negligent regarding the design or manufacture of the part. ON Semiconductor is an Equal Opportunity/Affirmative Action Employer. This literature is subject to all applicable copyright laws and is not for resale in any manner.

## PUBLICATION ORDERING INFORMATION

### LITERATURE FULFILLMENT:

Literature Distribution Center for ON Semiconductor  
19521 E. 32nd Pkwy, Aurora, Colorado 80011 USA  
**Phone:** 303-675-2175 or 800-344-3860 Toll Free USA/Canada  
**Fax:** 303-675-2176 or 800-344-3867 Toll Free USA/Canada  
**Email:** [orderlit@onsemi.com](mailto:orderlit@onsemi.com)

**N. American Technical Support:** 800-282-9855 Toll Free  
USA/Canada  
**Europe, Middle East and Africa Technical Support:**  
Phone: 421 33 790 2910  
**Japan Customer Focus Center**  
Phone: 81-3-5817-1050

**ON Semiconductor Website:** [www.onsemi.com](http://www.onsemi.com)  
**Order Literature:** <http://www.onsemi.com/orderlit>  
For additional information, please contact your local  
Sales Representative