

AUTOMOTIVE MOSFET

IRF7484Q

HEXFET® Power MOSFET

Typical Applications

- Relay replacement
- Anti-lock Braking System
- Air Bag

Benefits

- Advanced Process Technology
- Ultra Low On-Resistance
- Fast Switching
- Repetitive Avalanche Allowed up to Tjmax

| V _{DSS} | R _{DS(on)} max (mΩ) | I _D |
|------------------|------------------------------|----------------|
| 40V | 10@V _{GS} = 7.0V | 14A |

Description

Specifically designed for Automotive applications, this Stripe Planar design of HEXFET® Power MOSFETs utilizes the latest processing techniques to achieve extremely low on-resistance per silicon area. Additional features of this HEXFET power MOSFET are a 150°C junction operating temperature, fast switching speed and improved repetitive avalanche rating. These benefits combine to make this design an extremely efficient and reliable device for use in Automotive applications and a wide variety of other applications.

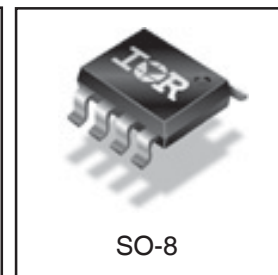
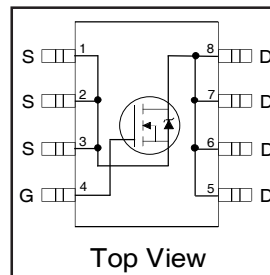

Absolute Maximum Ratings

| | Parameter | Max. | Units |
|--|---|--------------------------|-------|
| I _D @ T _A = 25°C | Continuous Drain Current, V _{GS} @ 10V | 14 | A |
| I _D @ T _A = 70°C | Continuous Drain Current, V _{GS} @ 10V | 11 | |
| I _{DM} | Pulsed Drain Current ① | 110 | A |
| P _D @ T _A = 25°C | Power Dissipation ③ | 2.5 | W |
| | Linear Derating Factor | 0.02 | W/°C |
| V _{GS} | Gate-to-Source Voltage | ± 8.0 | V |
| E _{AS} | Single Pulse Avalanche Energy ④ | 230 | mJ |
| I _{AR} | Avalanche Current ① | See Fig.16c, 16d, 19, 20 | A |
| E _{AR} | Repetitive Avalanche Energy ④ | | mJ |
| T _J , T _{STG} | Junction and Storage Temperature Range | -55 to + 150 | °C |

Thermal Resistance

| Symbol | Parameter | Typ. | Max. | Units |
|------------------|------------------------|------|------|-------|
| R _{θJL} | Junction-to-Drain Lead | — | 20 | °C/W |
| R _{θJA} | Junction-to-Ambient ③ | — | 50 | |

Electrical Characteristics @ $T_J = 25^\circ\text{C}$ (unless otherwise specified)

| | Parameter | Min. | Typ. | Max. | Units | Conditions |
|---------------------------------|--------------------------------------|------|-------|------|------------|--|
| $V_{(BR)DSS}$ | Drain-to-Source Breakdown Voltage | 40 | — | — | V | $V_{GS} = 0V, I_D = 250\mu A$ |
| $\Delta V_{(BR)DSS}/\Delta T_J$ | Breakdown Voltage Temp. Coefficient | — | 0.040 | — | V/°C | Reference to 25°C , $I_D = 1mA$ |
| $R_{DS(on)}$ | Static Drain-to-Source On-Resistance | — | — | 10 | m Ω | $V_{GS} = 7.0V, I_D = 14A$ ② |
| $V_{GS(th)}$ | Gate Threshold Voltage | 1.0 | — | 2.0 | V | $V_{DS} = V_{GS}, I_D = 250\mu A$ |
| g_{fs} | Forward Transconductance | 40 | — | — | S | $V_{DS} = 10V, I_D = 14A$ |
| I_{DSS} | Drain-to-Source Leakage Current | — | — | 20 | μA | $V_{DS} = 40V, V_{GS} = 0V$ |
| | | — | — | 250 | | $V_{DS} = 32V, V_{GS} = 0V, T_J = 125^\circ\text{C}$ |
| I_{GSS} | Gate-to-Source Forward Leakage | — | — | 200 | nA | $V_{GS} = 8.0V$ |
| | Gate-to-Source Reverse Leakage | — | — | -200 | | $V_{GS} = -8.0V$ |
| Q_g | Total Gate Charge | — | 69 | 100 | nC | $I_D = 14A$ |
| Q_{gs} | Gate-to-Source Charge | — | 9.0 | — | | $V_{DS} = 32V$ |
| Q_{gd} | Gate-to-Drain ("Miller") Charge | — | 16 | — | | $V_{GS} = 7.0V$ |
| $t_{d(on)}$ | Turn-On Delay Time | — | 9.3 | — | ns | $V_{DD} = 20V$ ② |
| t_r | Rise Time | — | 5.0 | — | | $I_D = 1.0A$ |
| $t_{d(off)}$ | Turn-Off Delay Time | — | 180 | — | | $R_G = 6.2\Omega$ |
| t_f | Fall Time | — | 58 | — | | $V_{GS} = 7.0V$ |
| C_{iss} | Input Capacitance | — | 3520 | — | pF | $V_{GS} = 0V$ |
| C_{oss} | Output Capacitance | — | 660 | — | | $V_{DS} = 25V$ |
| C_{rss} | Reverse Transfer Capacitance | — | 76 | — | | $f = 1.0MHz$ |

Source-Drain Ratings and Characteristics

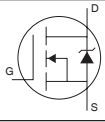
| | Parameter | Min. | Typ. | Max. | Units | Conditions |
|----------|--|------|------|------|-------|--|
| I_S | Continuous Source Current (Body Diode) | — | — | 2.3 | A | MOSFET symbol showing the integral reverse p-n junction diode.  |
| I_{SM} | Pulsed Source Current (Body Diode) ① | — | — | 110 | | |
| V_{SD} | Diode Forward Voltage | — | — | 1.3 | V | $T_J = 25^\circ\text{C}, I_S = 2.3A, V_{GS} = 0V$ ② |
| t_{rr} | Reverse Recovery Time | — | 59 | 89 | ns | $T_J = 25^\circ\text{C}, I_F = 2.3A$ |
| Q_{rr} | Reverse Recovery Charge | — | 110 | 170 | nC | $di/dt = 100A/\mu s$ ② |

Notes:

- ① Repetitive rating; pulse width limited by max. junction temperature.
- ② Pulse width $\leq 400\mu s$; duty cycle $\leq 2\%$.
- ③ Surface mounted on 1 in square Cu board.
- ④ Starting $T_J = 25^\circ\text{C}$, $L = 2.3mH$, $R_G = 25\Omega$, $I_{AS} = 14A$. (See Figure 12).
- ⑤ $I_{SD} \leq 14A$, $di/dt \leq 140A/\mu s$, $V_{DD} \leq V_{(BR)DSS}$, $T_J \leq 150^\circ\text{C}$.
- ⑥ Limited by T_{Jmax} , see Fig.16c, 16d, 19, 20 for typical repetitive avalanche performance.

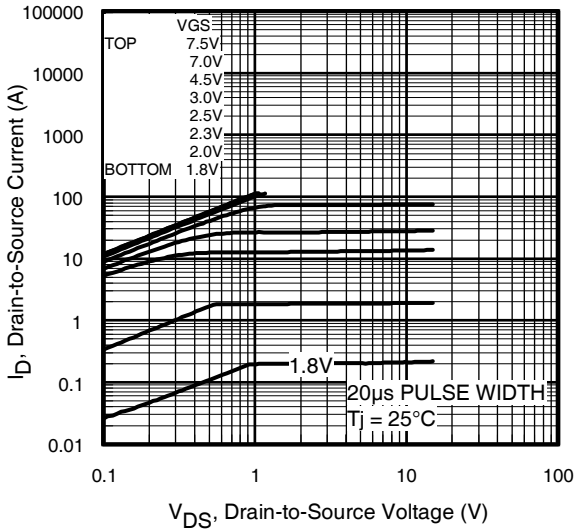

Fig 1. Typical Output Characteristics

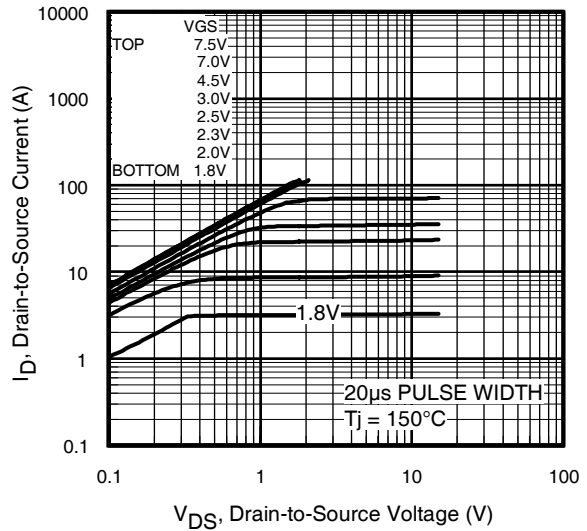

Fig 2. Typical Output Characteristics

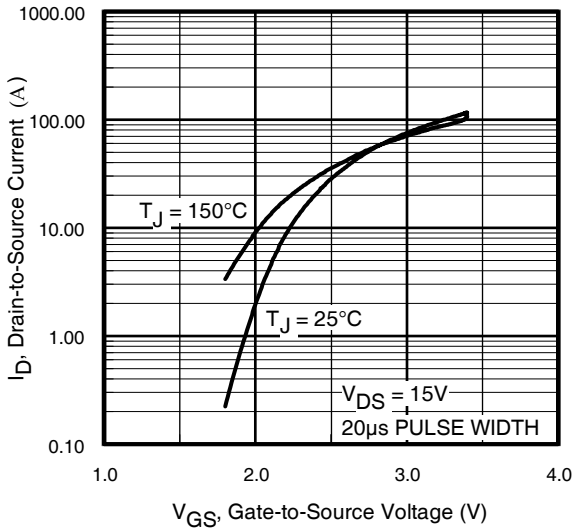

Fig 3. Typical Transfer Characteristics

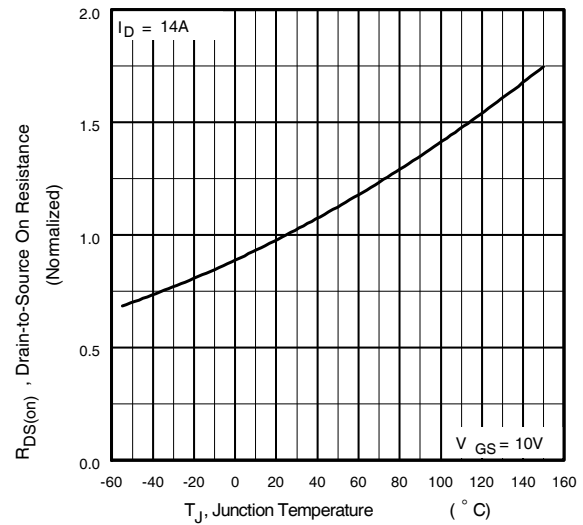

Fig 4. Normalized On-Resistance Vs. Temperature

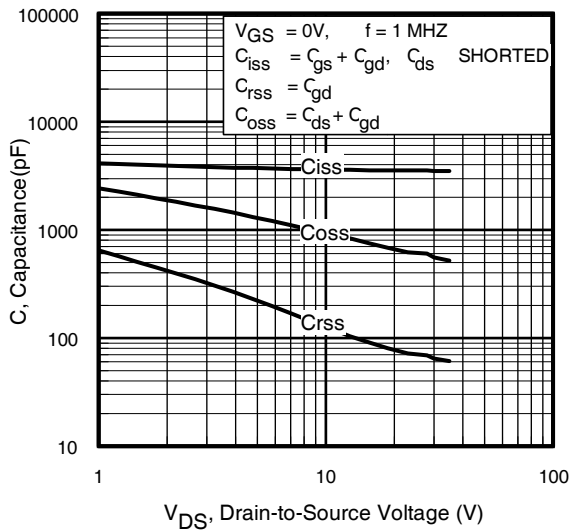

Fig 5. Typical Capacitance Vs. Drain-to-Source Voltage

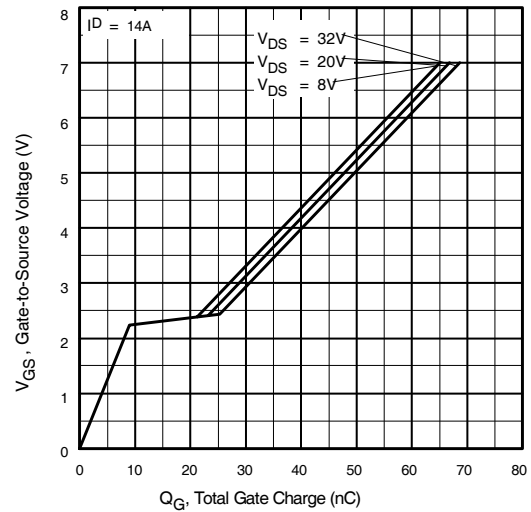

Fig 6. Typical Gate Charge Vs. Gate-to-Source Voltage

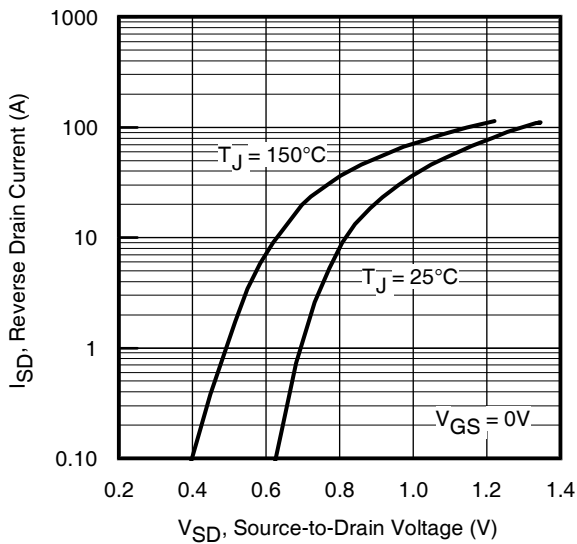

Fig 7. Typical Source-Drain Diode Forward Voltage

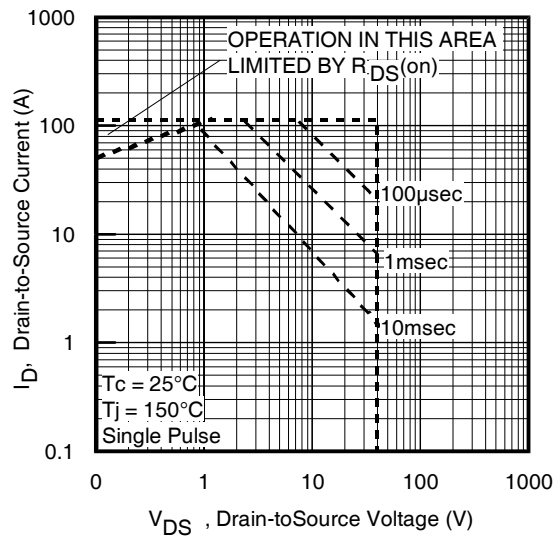

Fig 8. Maximum Safe Operating Area

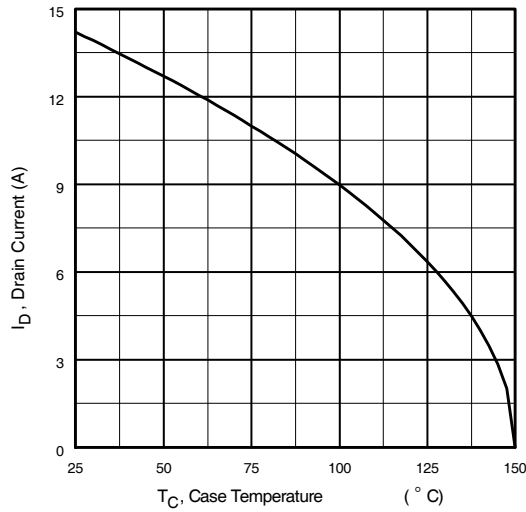

Fig 9. Maximum Drain Current Vs. Case Temperature

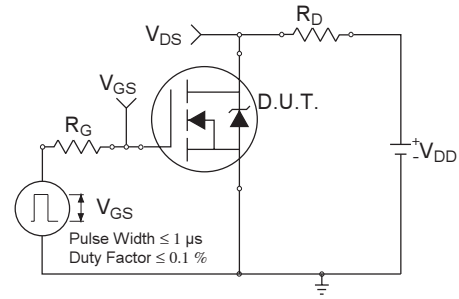

Fig 10a. Switching Time Test Circuit

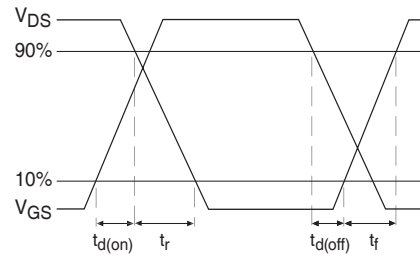

Fig 10b. Switching Time Waveforms

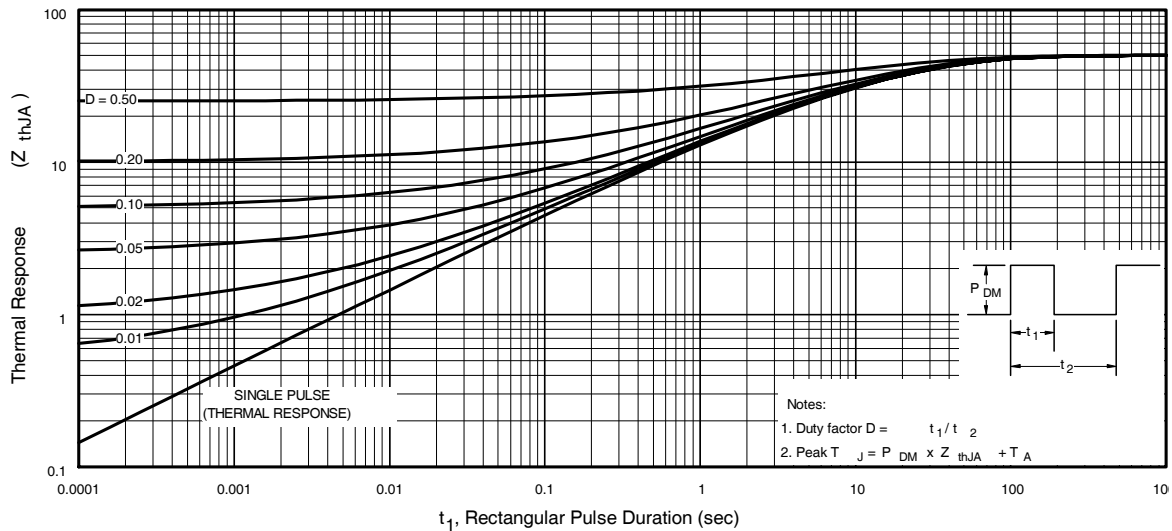

Fig 11. Typical Effective Transient Thermal Impedance, Junction-to-Ambient

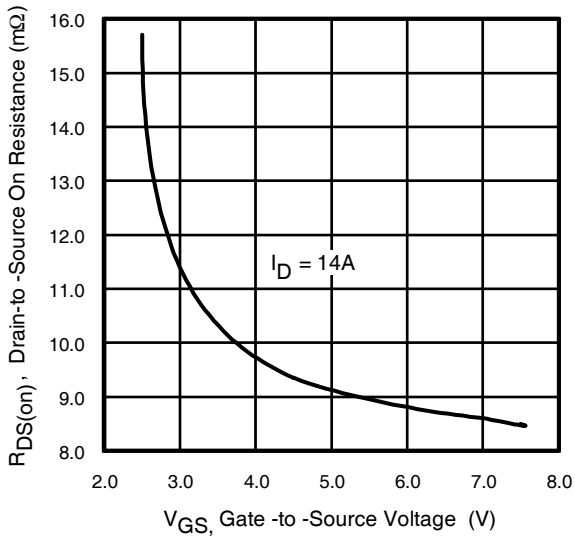

Fig 12. Typical On-Resistance Vs. Gate Voltage

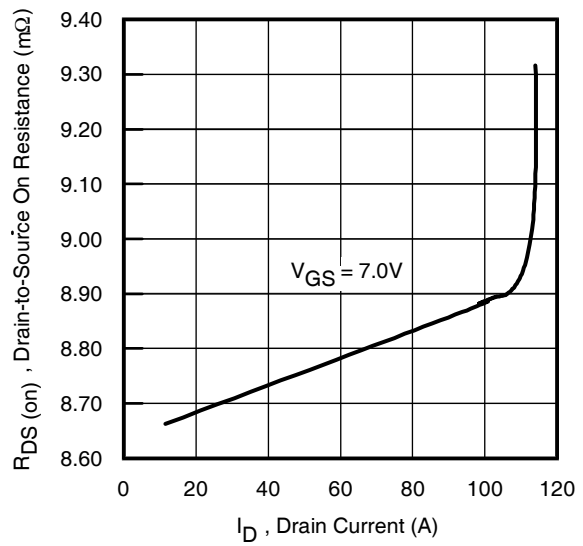

Fig 13. Typical On-Resistance Vs. Drain Current

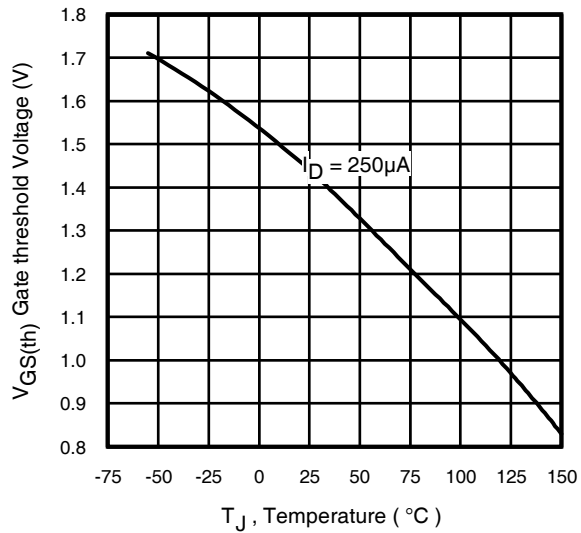

Fig 14. Typical Threshold Voltage Vs. Junction Temperature

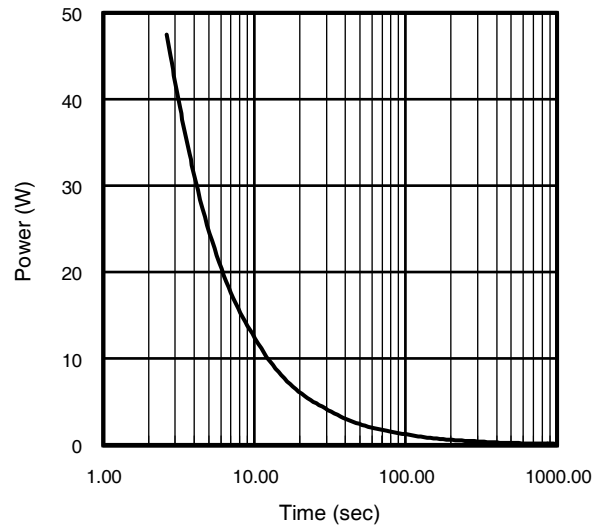

Fig 15. Typical Power Vs. Time

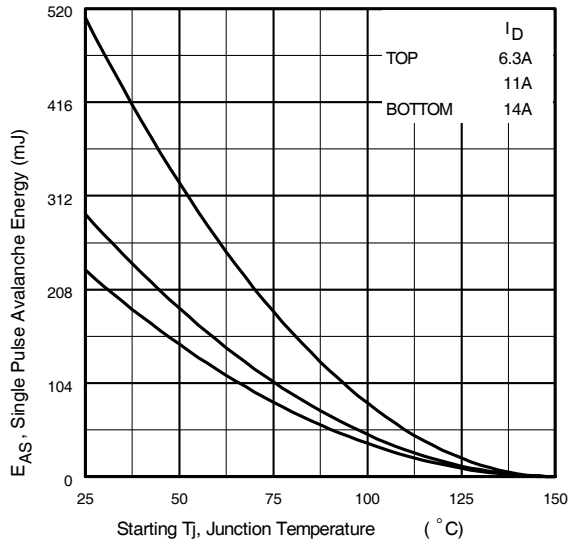

Fig 16a. Maximum Avalanche Energy Vs. Drain Current

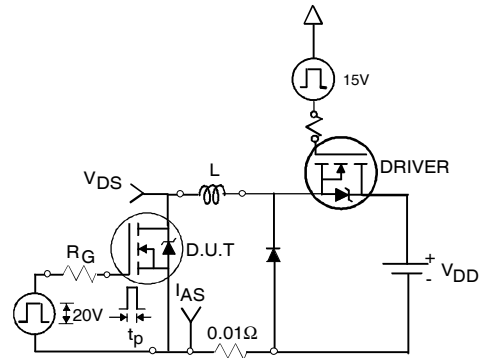

Fig 16c. Unclamped Inductive Test Circuit

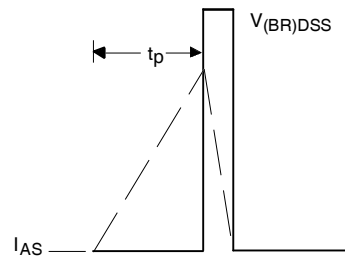

Fig 16d. Unclamped Inductive Waveforms

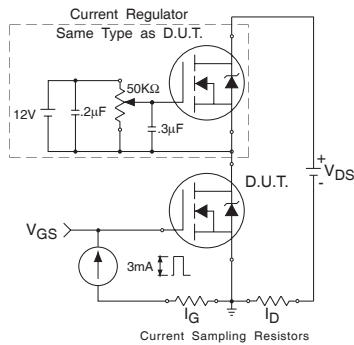

Fig 17. Gate Charge Test Circuit

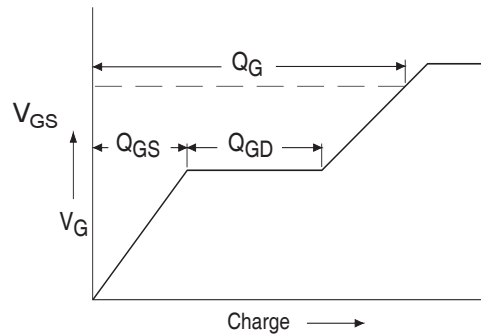

Fig 18. Basic Gate Charge Waveform

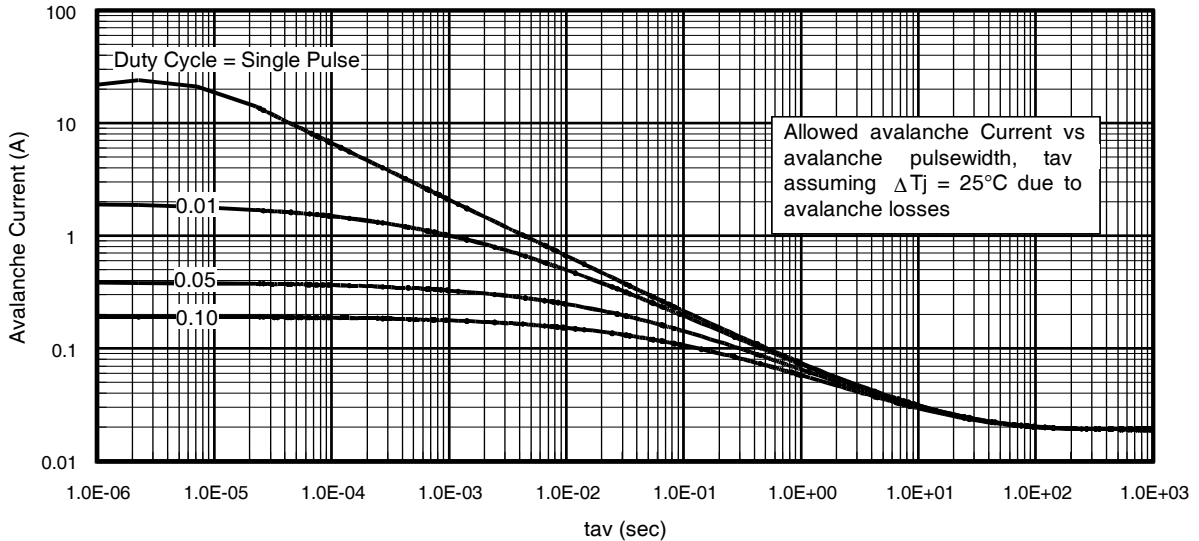

Fig 19. Typical Avalanche Current Vs.Pulsewidth

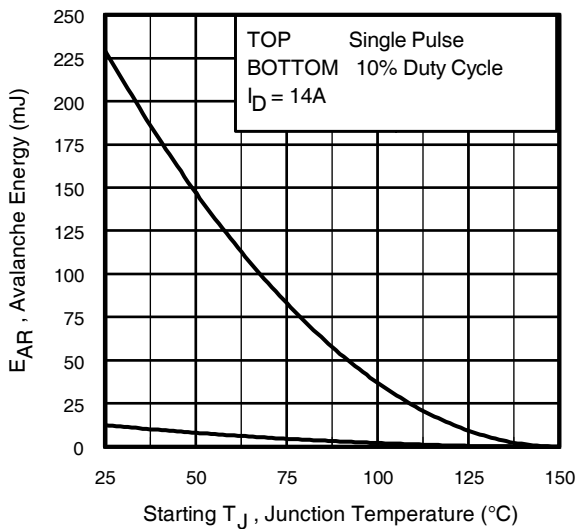

Fig 20. Maximum Avalanche Energy Vs. Temperature

Notes on Repetitive Avalanche Curves , Figures 15, 16:
(For further info, see AN-1005 at www.irf.com)

1. Avalanche failures assumption:
Purely a thermal phenomenon and failure occurs at a temperature far in excess of T_{jmax} . This is validated for every part type.
2. Safe operation in Avalanche is allowed as long as T_{jmax} is not exceeded.
3. Equation below based on circuit and waveforms shown in Figures 12a, 12b.
4. $P_{D(ave)}$ = Average power dissipation per single avalanche pulse.
5. BV = Rated breakdown voltage (1.3 factor accounts for voltage increase during avalanche).
6. I_{av} = Allowable avalanche current.
7. ΔT = Allowable rise in junction temperature, not to exceed T_{jmax} (assumed as 25°C in Figure 15, 16).
 t_{av} = Average time in avalanche.
 D = Duty cycle in avalanche = $t_{av} \cdot f$
 $Z_{thJC}(D, t_{av})$ = Transient thermal resistance, see figure 11)

$$P_{D(ave)} = 1/2 (1.3 \cdot BV \cdot I_{av}) = \Delta T / Z_{thJC}$$

$$I_{av} = 2\Delta T / [1.3 \cdot BV \cdot Z_{th}]$$

$$E_{AS(AR)} = P_{D(ave)} \cdot t_{av}$$

SO-8 Package Details

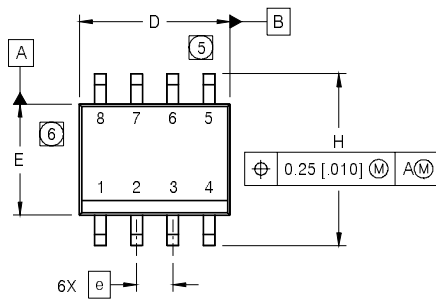

| DIM | INCHES | | MILLIMETERS | |
|-----|------------|-------|-------------|------|
| | MIN | MAX | MIN | MAX |
| A | .0532 | .0688 | 1.35 | 1.75 |
| A1 | .0040 | .0098 | 0.10 | 0.25 |
| b | .013 | .020 | 0.33 | 0.51 |
| c | .0075 | .0098 | 0.19 | 0.25 |
| D | .189 | .1968 | 4.80 | 5.00 |
| E | .1497 | .1574 | 3.80 | 4.00 |
| e | .050 BASIC | | 1.27 BASIC | |
| e1 | .025 BASIC | | 0.635 BASIC | |
| H | .2284 | .2440 | 5.80 | 6.20 |
| K | .0099 | .0196 | 0.25 | 0.50 |
| L | .016 | .050 | 0.40 | 1.27 |
| y | 0° | 8° | 0° | 8° |

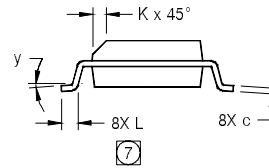
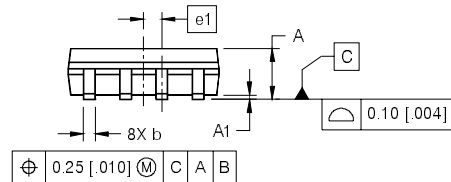

NOTES:

- DIMENSIONING & TOLERANCING PER ASME Y14.5M-1994.
- CONTROLLING DIMENSION: MILLIMETER
- DIMENSIONS ARE SHOWN IN MILLIMETERS [INCHES].
- OUTLINE CONFORMS TO JEDEC OUTLINE MS-012AA.
- DIMENSION DOES NOT INCLUDE MOLD PROTRUSIONS. MOLD PROTRUSIONS NOT TO EXCEED 0.15 [0.006].
- DIMENSION DOES NOT INCLUDE MOLD PROTRUSIONS. MOLD PROTRUSIONS NOT TO EXCEED 0.25 [0.010].
- DIMENSION IS THE LENGTH OF LEAD FOR SOLDERING TO A SUBSTRATE.

FOOTPRINT

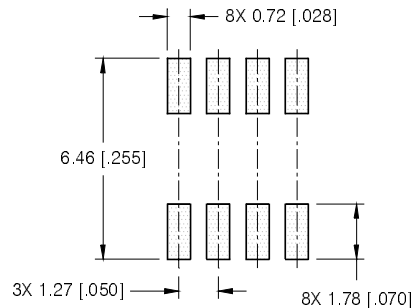

SO-8 Part Marking

EXAMPLE: THIS IS AN IRF7101 (MOSFET)

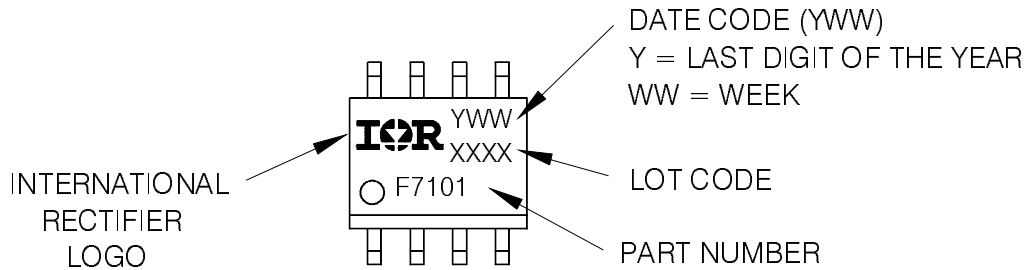

IRF7484Q

International
IR Rectifier

SO-8 Tape and Reel

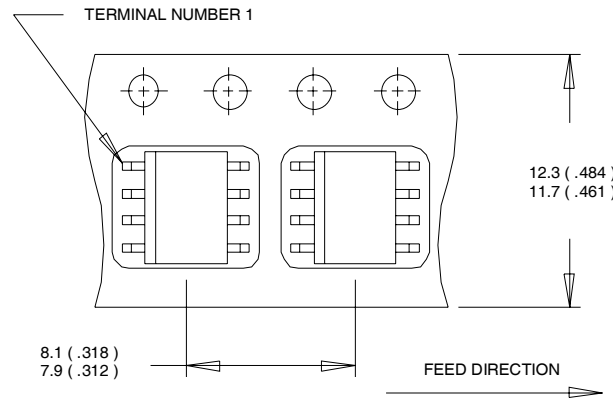

NOTES:

1. CONTROLLING DIMENSION : MILLIMETER.
2. ALL DIMENSIONS ARE SHOWN IN MILLIMETERS(INCHES).
3. OUTLINE CONFORMS TO EIA-481 & EIA-541.

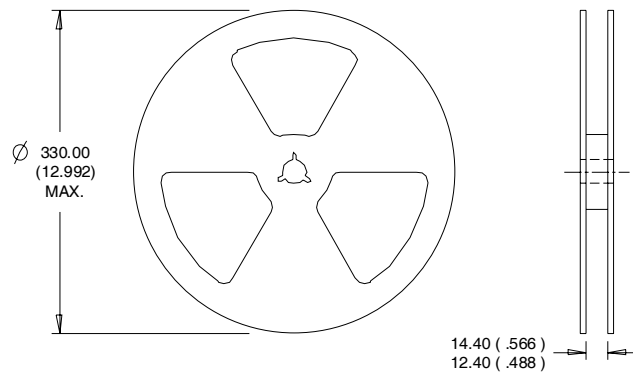

NOTES :

1. CONTROLLING DIMENSION : MILLIMETER.
2. OUTLINE CONFORMS TO EIA-481 & EIA-541.

Data and specifications subject to change without notice.
This product has been designed and qualified for the Automotive [Q101] market.
Qualification Standards can be found on IR's Web site.

International
IR Rectifier

IR WORLD HEADQUARTERS: 233 Kansas St., El Segundo, California 90245, USA Tel: (310) 252-7105
TAC Fax: (310) 252-7903

Visit us at www.irf.com for sales contact information. 01/05

www.irf.com