

## Dual N-Channel 20 V (D-S) MOSFET

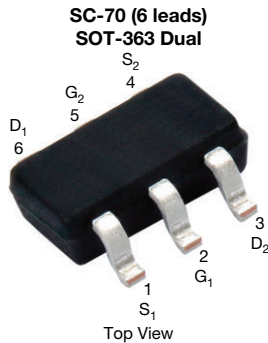

Marking code: PE

PRODUCT SUMMARY	
$V_{DS}$ (V)	20
$R_{DS(on)}$ max. ( $\Omega$ ) at $V_{GS} = 4.5$ V	0.235
$R_{DS(on)}$ max. ( $\Omega$ ) at $V_{GS} = 2.5$ V	0.306
$Q_g$ typ. (nC)	0.9
$I_D$ (A) <sup>a</sup>	1.1
Configuration	Dual

### FEATURES

- TrenchFET® power MOSFET
- 100 %  $R_g$  tested
- Material categorization: for definitions of compliance please see [www.vishay.com/doc?99912](http://www.vishay.com/doc?99912)

**RoHS**  
 COMPLIANT  
 HALOGEN  
**FREE**

### APPLICATIONS

- Load switch and DC/DC converter for portable devices
- High speed switching

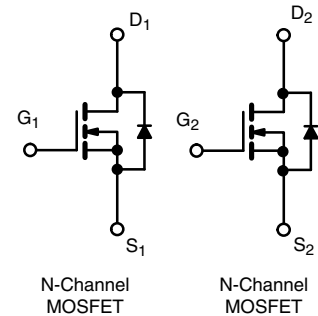

ORDERING INFORMATION	
Package	SC-70
Lead (Pb)-free and halogen-free	Si1902CDL-T1-GE3

ABSOLUTE MAXIMUM RATINGS ( $T_A = 25$ °C, unless otherwise noted)				
PARAMETER	SYMBOL	LIMIT	UNIT	
Drain-source voltage	$V_{DS}$	20	V	
Gate-source voltage	$V_{GS}$	$\pm 12$		
Continuous drain current ( $T_J = 150$ °C)	$I_D$	$T_C = 25$ °C	1.1	A
		$T_C = 70$ °C	0.9	
		$T_A = 25$ °C	1 <sup>b, c</sup>	
		$T_A = 70$ °C	0.8 <sup>b, c</sup>	
Pulsed drain current ( $t = 300$ $\mu$ s)	$I_{DM}$	2		
Continuous source-drain diode current	$I_S$	$T_C = 25$ °C	0.35	
		$T_A = 25$ °C	0.25 <sup>b, c</sup>	
Maximum power dissipation	$P_D$	$T_C = 25$ °C	0.42	W
		$T_C = 70$ °C	0.27	
		$T_A = 25$ °C	0.30 <sup>b, c</sup>	
		$T_A = 70$ °C	0.23 <sup>b, c</sup>	
Operating junction and storage temperature range	$T_J, T_{stg}$	-55 to +150	°C	

THERMAL RESISTANCE RATINGS					
PARAMETER	SYMBOL	TYPICAL	MAXIMUM	UNIT	
Maximum junction-to-ambient <sup>b, d</sup>	$R_{thJA}$	290	350	°C/W	
Maximum junction-to-foot (drain)	$R_{thJF}$	250	300		

### Notes

- Based on  $T_C = 25$  °C
- Surface mounted on 1" x 1" FR4 board
- $t = 5$  s
- Maximum under steady state conditions is 410 °C/W



SPECIFICATIONS ( $T_J = 25\text{ }^\circ\text{C}$ , unless otherwise noted)						
PARAMETER	SYMBOL	TEST CONDITIONS	MIN.	TYP.	MAX.	UNIT
<b>Static</b>						
Drain-source breakdown voltage	$V_{DS}$	$V_{GS} = 0\text{ V}, I_D = 250\text{ }\mu\text{A}$	20	-	-	V
$V_{DS}$ temperature coefficient	$\Delta V_{DS}/T_J$	$I_D = 250\text{ }\mu\text{A}$	-	25	-	mV/ $^\circ\text{C}$
$V_{GS(th)}$ temperature coefficient	$\Delta V_{GS(th)}/T_J$		-	-2.6	-	
Gate-source threshold voltage	$V_{GS(th)}$	$V_{DS} = V_{GS}, I_D = 250\text{ }\mu\text{A}$	0.6	-	1.5	V
Gate-source leakage	$I_{GSS}$	$V_{DS} = 0\text{ V}, V_{GS} = \pm 12\text{ V}$	-	-	$\pm 100$	nA
Zero gate voltage drain current	$I_{DSS}$	$V_{DS} = 20\text{ V}, V_{GS} = 0\text{ V}$	-	-	1	$\mu\text{A}$
		$V_{DS} = 20\text{ V}, V_{GS} = 0\text{ V}, T_J = 85\text{ }^\circ\text{C}$	-	-	10	
On-state drain current <sup>a</sup>	$I_{D(on)}$	$V_{DS} \geq 5\text{ V}, V_{GS} = 4.5\text{ V}$	2	-	-	A
Drain-source on-state resistance <sup>a</sup>	$R_{DS(on)}$	$V_{GS} = 4.5\text{ V}, I_D = 1\text{ A}$	-	0.195	0.235	$\Omega$
		$V_{GS} = 2.5\text{ V}, I_D = 0.3\text{ A}$	-	0.255	0.306	
Forward transconductance	$g_{fs}$	$V_{DS} = 10\text{ V}, I_D = 1\text{ A}$	-	3	-	ms
<b>Dynamic <sup>b</sup></b>						
Input capacitance	$C_{iss}$	$V_{DS} = 10\text{ V}, V_{GS} = 0\text{ V}, f = 1\text{ MHz}$	-	62	-	pF
Output capacitance	$C_{oss}$		-	20	-	
Reverse transfer capacitance	$C_{rss}$		-	7	-	
Total gate charge	$Q_g$	$V_{DS} = 10\text{ V}, V_{GS} = 10\text{ V}, I_D = 1\text{ A}$	-	2	3	nC
		$V_{DS} = 10\text{ V}, V_{GS} = 4.5\text{ V}, I_D = 1\text{ A}$	-	0.9	1.4	
Gate-source charge	$Q_{gs}$	$V_{DS} = 10\text{ V}, V_{GS} = 4.5\text{ V}, I_D = 1\text{ A}$	-	0.2	-	nC
Gate-drain charge	$Q_{gd}$		-	0.2	-	
Gate resistance	$R_g$		$f = 1\text{ MHz}$	2.4	12	
Turn-on delay time	$t_{d(on)}$	$V_{DD} = 10\text{ V}, R_L = 12.5\text{ }\Omega$ $I_D \cong 0.8\text{ A}, V_{GEN} = 10\text{ V}, R_g = 1\text{ }\Omega$	-	4	8	ns
Rise time	$t_r$		-	13	20	
Turn-off delay time	$t_{d(off)}$		-	11	20	
Fall time	$t_f$		-	9	18	
Turn-on delay time	$t_{d(on)}$	$V_{DD} = 10\text{ V}, R_L = 12.5\text{ }\Omega$ $I_D \cong 0.8\text{ A}, V_{GEN} = 4.5\text{ V}, R_g = 1\text{ }\Omega$	-	6	12	ns
Rise time	$t_r$		-	16	24	
Turn-off delay time	$t_{d(off)}$		-	13	20	
Fall time	$t_f$		-	10	20	
<b>Drain-Source Body Diode Characteristics</b>						
Continuous source-drain diode current	$I_S$	$T_C = 25\text{ }^\circ\text{C}$	-	-	0.35	A
Pulse diode forward current <sup>a</sup>	$I_{SM}$		-	-	2	
Body diode voltage	$V_{SD}$	$I_S = 0.8\text{ A}$	-	0.8	1.2	V
Body diode reverse recovery time	$t_{rr}$	$I_F = 0.8\text{ A}, di/dt = 100\text{ A}/\mu\text{s}$	-	2	4	nC
Body diode reverse recovery charge	$Q_{rr}$		-	8	16	
Reverse recovery fall time	$t_a$		-	5	-	ns
Reverse recovery rise time	$t_b$		-	3	-	

**Notes**

- a. Pulse test; pulse width  $\leq 300\text{ }\mu\text{s}$ , duty cycle  $\leq 2\%$   
b. Guaranteed by design, not subject to production testing

Stresses beyond those listed under "Absolute Maximum Ratings" may cause permanent damage to the device. These are stress ratings only, and functional operation of the device at these or any other conditions beyond those indicated in the operational sections of the specifications is not implied. Exposure to absolute maximum rating conditions for extended periods may affect device reliability.



**TYPICAL CHARACTERISTICS** (25 °C, unless otherwise noted)

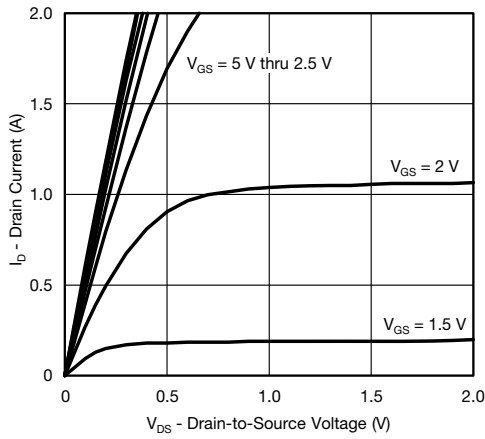

**Output Characteristics**

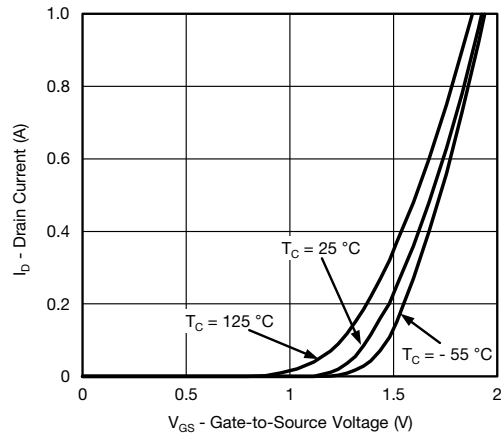

**Transfer Characteristics**

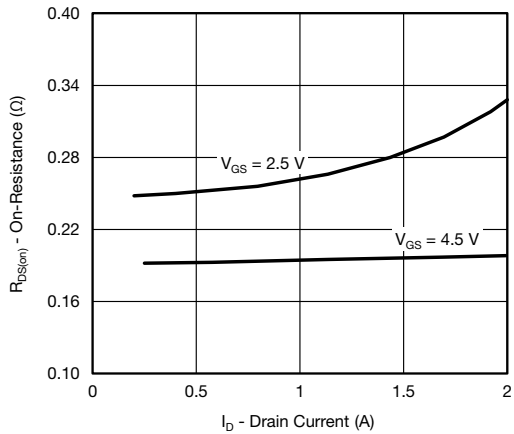

**On-Resistance vs. Drain Current and Gate Voltage**

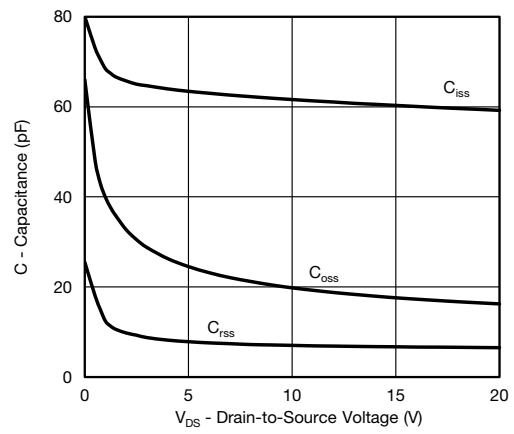

**Capacitance**

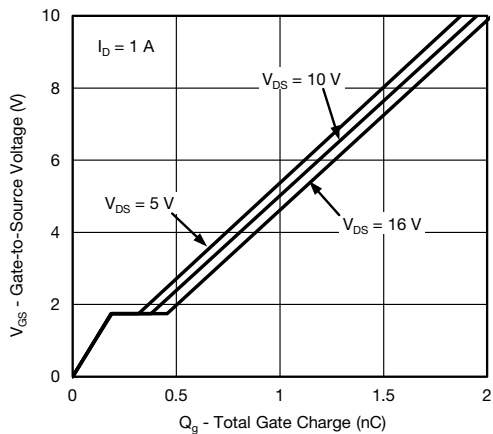

**Gate Charge**

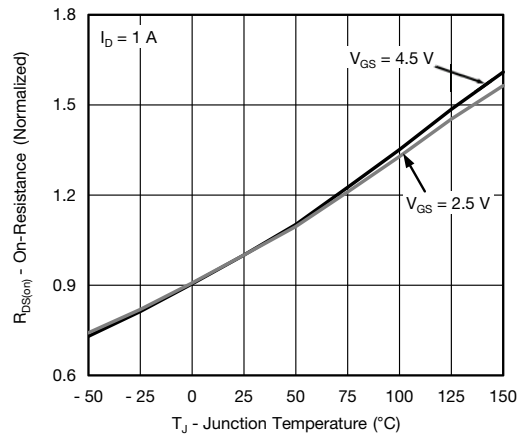

**On-Resistance vs. Junction Temperature**



**TYPICAL CHARACTERISTICS** (25 °C, unless otherwise noted)

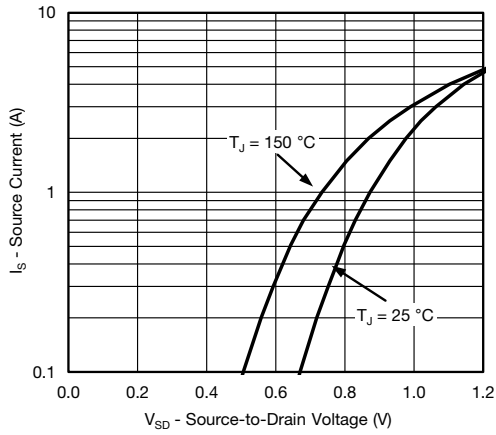

**Source-Drain Diode Forward Voltage**

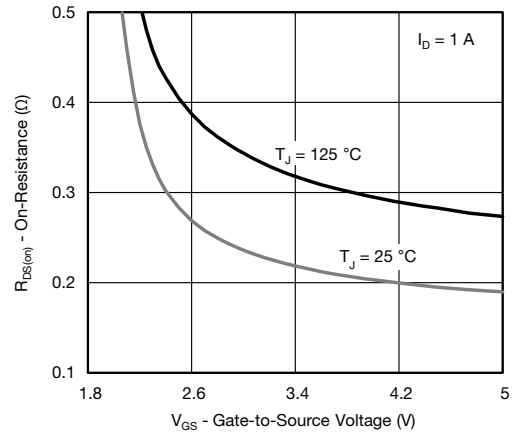

**On-Resistance vs. Gate-to-Source Voltage**

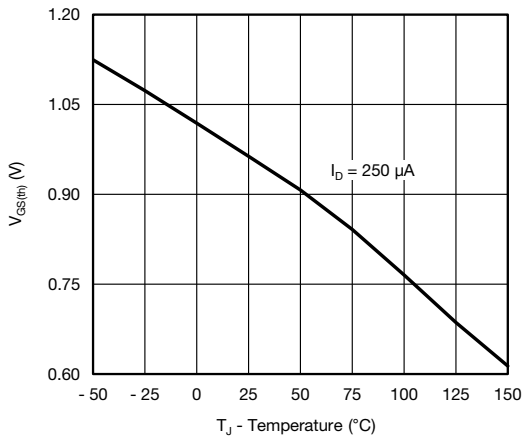

**Threshold Voltage**

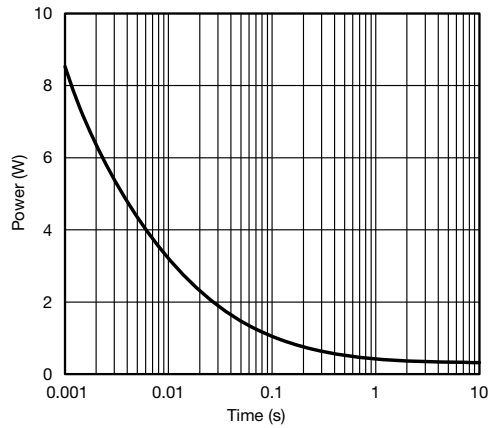

**Single Pulse Power (Junction-to-Ambient)**

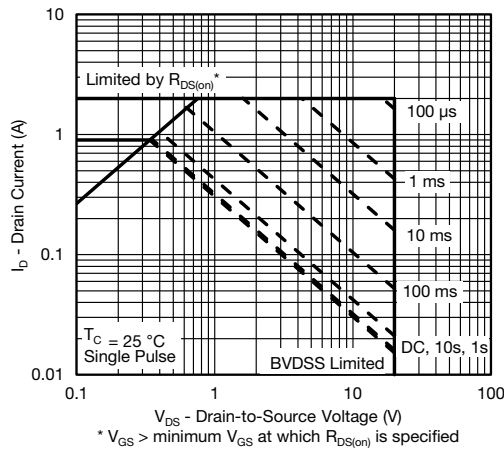

**Safe Operating Area, Junction-to-Ambient**



**TYPICAL CHARACTERISTICS** (25 °C, unless otherwise noted)

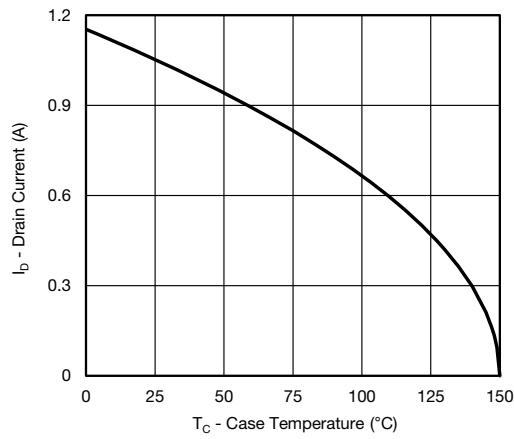

**Current Derating <sup>a</sup>**

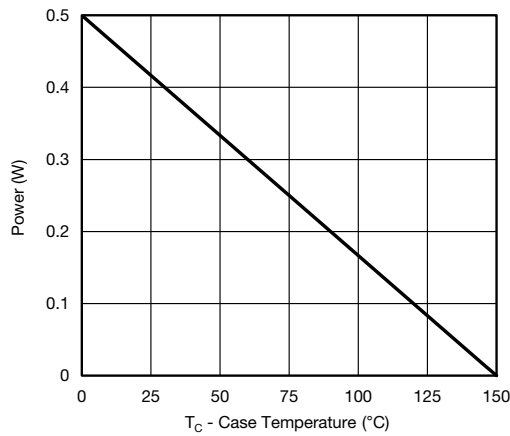

**Power Derating, Junction-to-Foot**

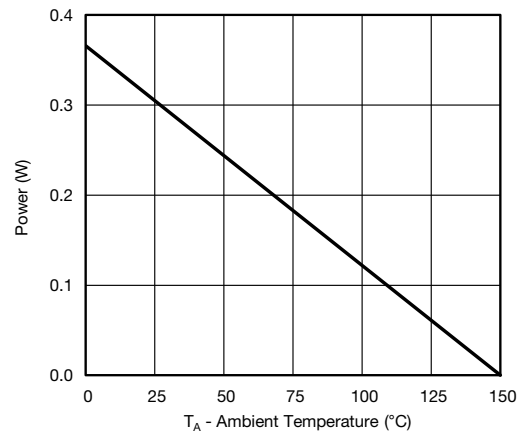

**Power Derating, Junction-to-Ambient**

**Note**

- a. The power dissipation P<sub>D</sub> is based on T<sub>J</sub> max. = 150 °C, using junction-to-case thermal resistance, and is more useful in settling the upper dissipation limit for cases where additional heatsinking is used. It is used to determine the current rating, when this rating falls below the package limit



**TYPICAL CHARACTERISTICS** (25 °C, unless otherwise noted)

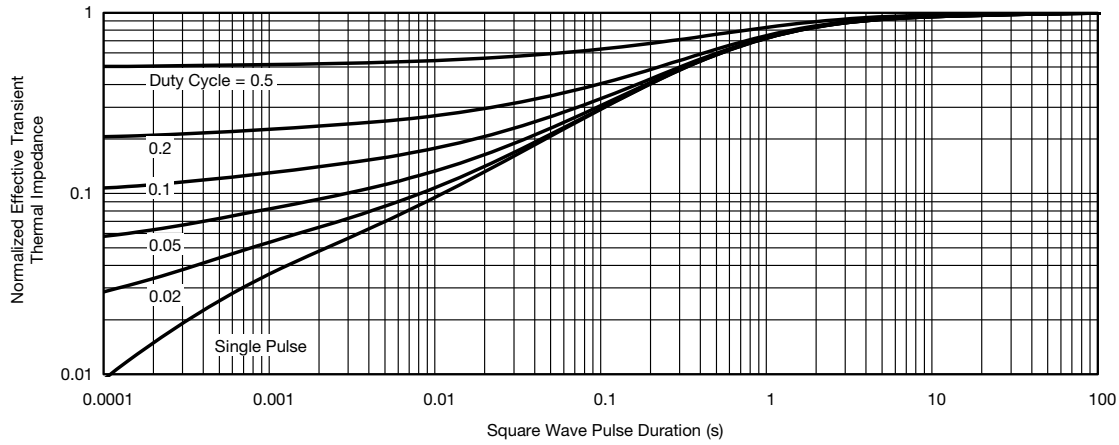

**Normalized Thermal Transient Impedance, Junction-to-Ambient**

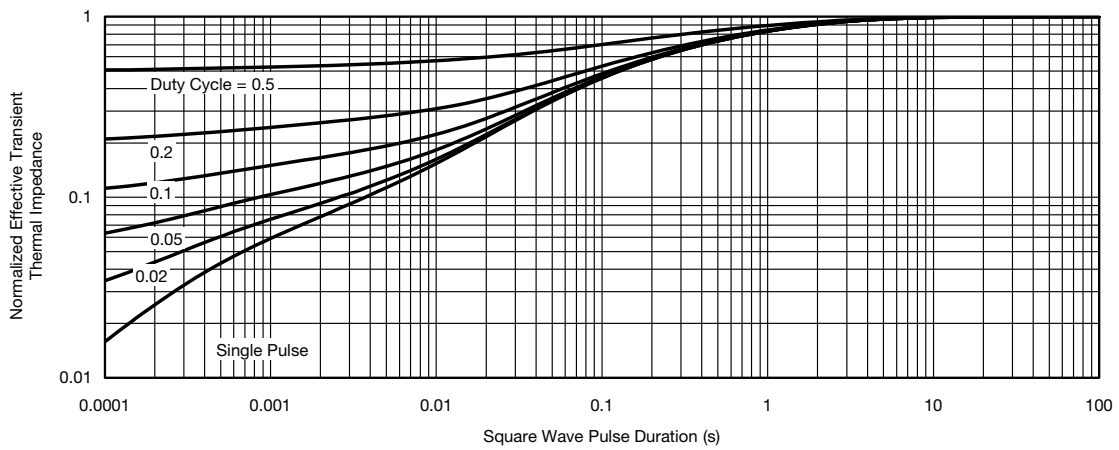

**Normalized Thermal Transient Impedance, Junction-to-Foot**

Vishay Siliconix maintains worldwide manufacturing capability. Products may be manufactured at one of several qualified locations. Reliability data for silicon technology and package reliability represent a composite of all qualified locations. For related documents such as package / tape drawings, part marking, and reliability data, see [www.vishay.com/ppg?67876](http://www.vishay.com/ppg?67876).



## Disclaimer

ALL PRODUCT, PRODUCT SPECIFICATIONS AND DATA ARE SUBJECT TO CHANGE WITHOUT NOTICE TO IMPROVE RELIABILITY, FUNCTION OR DESIGN OR OTHERWISE.

Vishay Intertechnology, Inc., its affiliates, agents, and employees, and all persons acting on its or their behalf (collectively, "Vishay"), disclaim any and all liability for any errors, inaccuracies or incompleteness contained in any datasheet or in any other disclosure relating to any product.

Vishay makes no warranty, representation or guarantee regarding the suitability of the products for any particular purpose or the continuing production of any product. To the maximum extent permitted by applicable law, Vishay disclaims (i) any and all liability arising out of the application or use of any product, (ii) any and all liability, including without limitation special, consequential or incidental damages, and (iii) any and all implied warranties, including warranties of fitness for particular purpose, non-infringement and merchantability.

Statements regarding the suitability of products for certain types of applications are based on Vishay's knowledge of typical requirements that are often placed on Vishay products in generic applications. Such statements are not binding statements about the suitability of products for a particular application. It is the customer's responsibility to validate that a particular product with the properties described in the product specification is suitable for use in a particular application. Parameters provided in datasheets and / or specifications may vary in different applications and performance may vary over time. All operating parameters, including typical parameters, must be validated for each customer application by the customer's technical experts. Product specifications do not expand or otherwise modify Vishay's terms and conditions of purchase, including but not limited to the warranty expressed therein.

Hyperlinks included in this datasheet may direct users to third-party websites. These links are provided as a convenience and for informational purposes only. Inclusion of these hyperlinks does not constitute an endorsement or an approval by Vishay of any of the products, services or opinions of the corporation, organization or individual associated with the third-party website. Vishay disclaims any and all liability and bears no responsibility for the accuracy, legality or content of the third-party website or for that of subsequent links.

Except as expressly indicated in writing, Vishay products are not designed for use in medical, life-saving, or life-sustaining applications or for any other application in which the failure of the Vishay product could result in personal injury or death. Customers using or selling Vishay products not expressly indicated for use in such applications do so at their own risk. Please contact authorized Vishay personnel to obtain written terms and conditions regarding products designed for such applications.

No license, express or implied, by estoppel or otherwise, to any intellectual property rights is granted by this document or by any conduct of Vishay. Product names and markings noted herein may be trademarks of their respective owners.