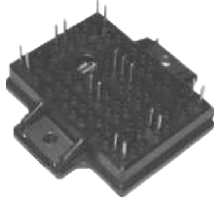

3-Levels Half Bridge Inverter Stage, 60 A, 57 A

EMIPAK2
FEATURES

- Warp1 and Warp2 PFC IGBT
- FRED Pt® and HEXFRED® antiparallel diodes
- FRED Pt® clamping diodes
- Integrated thermistor
- Square RBSOA
- Low internal inductances
- Low switching loss
- UL approved file E78996
- Material categorization: for definitions of compliance please see www.vishay.com/doc?99912

RoHS
COMPLIANT

PRODUCT SUMMARY	
1° LEVEL OF HALF-BRIDGE	
V_{CES}	600 V
$V_{CE(ON)}$ typical at $I_C = 50$ A	1.8 V
I_C at $T_C = 98$ °C	50 A
2° LEVEL OF HALF-BRIDGE	
V_{CES}	900 V
$V_{CE(ON)}$ typical at $I_C = 50$ A	2.73 V
I_C at $T_C = 93$ °C	50 A
Speed	30 kHz to 150 kHz
Package	EMIPAK2
Circuit	3-levels half bridge inverter stage

DESCRIPTION

VS-EMF050J60U is an integrated solution for a multi level inverter half-bridge in a single package. The EMIPAK2 package is easy to use thanks to the solderable terminals and provides improved thermal performance thanks to the exposed substrate. The optimized layout also helps to minimize stray parameters, allowing for better EMI performance.

ABSOLUTE MAXIMUM RATINGS				
PARAMETER	SYMBOL	TEST CONDITIONS	MAX.	UNITS
Operating junction temperature	T_J		150	°C
Storage temperature range	T_{Stg}		-40 to +125	
RMS isolation voltage	V_{ISOL}	$T_J = 25$ °C, all terminals shorted, $f = 50$ Hz, $t = 1$ s	3500	V
Q1 - Q4 IGBT				
Collector to emitter voltage	V_{CES}		600	V
Gate to emitter voltage	V_{GES}		20	
Pulsed collector current	I_{CM}		150	A
Clamped inductive load current	$I_{LM}^{(1)}$		150	
Continuous collector current	I_C	$T_C = 25$ °C	88	A
		$T_C = 80$ °C	60	
Power dissipation	P_D	$T_C = 25$ °C	338	W
		$T_C = 80$ °C	189	
Q2 - Q3 IGBT				
Collector to emitter voltage	V_{CES}		900	V
Gate to emitter voltage	V_{GES}		20	
Pulsed collector current	I_{CM}		150	A
Clamped inductive load current	$I_{LM}^{(2)}$		150	
Continuous collector current	I_C	$T_C = 25$ °C	85	A
		$T_C = 80$ °C	57	
Power dissipation	P_D	$T_C = 25$ °C	338	W
		$T_C = 80$ °C	189	



ABSOLUTE MAXIMUM RATINGS				
PARAMETER	SYMBOL	TEST CONDITIONS	MAX.	UNITS
D1 - D2 CLAMPING DIODE				
Repetitive peak reverse voltage	V_{RRM}		600	V
Single pulse forward current	I_{FSM}	10 ms sine or 6 ms rectangular pulse, $T_J = 25\text{ }^\circ\text{C}$	270	A
Diode continuous forward current	I_F	$T_C = 25\text{ }^\circ\text{C}$	68	
		$T_C = 80\text{ }^\circ\text{C}$	46	
Power dissipation	P_D	$T_C = 25\text{ }^\circ\text{C}$	150	W
		$T_C = 80\text{ }^\circ\text{C}$	84	
D3 - D4 AP DIODE				
Single pulse forward current	I_{FSM}	10 ms sine or 6 ms rectangular pulse, $T_J = 25\text{ }^\circ\text{C}$	280	A
Diode continuous forward current	I_F	$T_C = 25\text{ }^\circ\text{C}$	53	
		$T_C = 80\text{ }^\circ\text{C}$	36	
Power dissipation	P_D	$T_C = 25\text{ }^\circ\text{C}$	176	W
		$T_C = 80\text{ }^\circ\text{C}$	99	
D5 - D6 AP DIODE				
Single pulse forward current	I_{FSM}	10 ms sine or 6 ms rectangular pulse, $T_J = 25\text{ }^\circ\text{C}$	220	A
Diode continuous forward current	I_F	$T_C = 25\text{ }^\circ\text{C}$	46	A
		$T_C = 80\text{ }^\circ\text{C}$	31	
Power dissipation	P_D	$T_C = 25\text{ }^\circ\text{C}$	96	W
		$T_C = 80\text{ }^\circ\text{C}$	54	

Notes

- Absolute Maximum Ratings indicate sustained limits beyond which damage to the device may occur.
- (1) $V_{CC} = 400\text{ V}$, $V_{GE} = 15\text{ V}$, $L = 500\text{ }\mu\text{H}$, $R_g = 22\text{ }\Omega$, $T_J = 150\text{ }^\circ\text{C}$
- (2) $V_{CC} = 720\text{ V}$, $V_{GE} = 15\text{ V}$, $L = 500\text{ }\mu\text{H}$, $R_g = 22\text{ }\Omega$, $T_J = 150\text{ }^\circ\text{C}$

ELECTRICAL SPECIFICATIONS ($T_J = 25\text{ }^\circ\text{C}$ unless otherwise noted)						
PARAMETER	SYMBOL	TEST CONDITIONS	MIN.	TYP.	MAX.	UNITS
Q1 - Q4 IGBT						
Collector to emitter breakdown voltage	BV_{CES}	$V_{GE} = 0\text{ V}$, $I_C = 500\text{ }\mu\text{A}$	600	-	-	V
Temperature coefficient of breakdown voltage	$\Delta BV_{CES}/\Delta T_J$	$V_{GE} = 0\text{ V}$, $I_C = 500\text{ }\mu\text{A}$ ($25\text{ }^\circ\text{C}$ to $125\text{ }^\circ\text{C}$)	-	0.1	-	V/ $^\circ\text{C}$
Collector to emitter voltage	$V_{CE(ON)}$	$V_{GE} = 15\text{ V}$, $I_C = 27\text{ A}$	-	1.44	1.75	V
		$V_{GE} = 15\text{ V}$, $I_C = 50\text{ A}$	-	1.8	2.1	
		$V_{GE} = 15\text{ V}$, $I_C = 27\text{ A}$, $T_J = 125\text{ }^\circ\text{C}$	-	1.7	2.05	
		$V_{GE} = 15\text{ V}$, $I_C = 50\text{ A}$, $T_J = 125\text{ }^\circ\text{C}$	-	2.2	2.5	
Gate threshold voltage	$V_{GE(th)}$	$V_{CE} = V_{GE}$, $I_C = 250\text{ }\mu\text{A}$	2.9	3.9	5.3	
Temperature coefficient of threshold voltage	$\Delta V_{GE(th)}/\Delta T_J$	$V_{CE} = V_{GE}$, $I_C = 1\text{ mA}$ ($25\text{ }^\circ\text{C}$ to $125\text{ }^\circ\text{C}$)	-	-10	-	mV/ $^\circ\text{C}$
Forward transconductance	g_{fe}	$V_{CE} = 20\text{ V}$, $I_C = 50\text{ A}$	-	95	-	s
Transfer characteristics	V_{GE}	$V_{CE} = 20\text{ V}$, $I_C = 50\text{ A}$	-	5.9	-	V
Zero gate voltage collector current	I_{CES}	$V_{GE} = 0\text{ V}$, $V_{CE} = 600\text{ V}$	-	0.003	0.1	mA
		$V_{GE} = 0\text{ V}$, $V_{CE} = 600\text{ V}$, $T_J = 125\text{ }^\circ\text{C}$	-	0.170	3	
Gate to emitter leakage current	I_{GES}	$V_{GE} = \pm 20\text{ V}$, $V_{CE} = 0\text{ V}$	-	-	± 200	nA



ELECTRICAL SPECIFICATIONS ($T_J = 25\text{ }^\circ\text{C}$ unless otherwise noted)						
PARAMETER	SYMBOL	TEST CONDITIONS	MIN.	TYP.	MAX.	UNITS
Q2 - Q3 IGBT						
Collector to emitter breakdown voltage	BV_{CES}	$V_{GE} = 0\text{ V}, I_C = 500\text{ }\mu\text{A}$	900	-	-	V
Temperature coefficient of breakdown voltage	$\Delta BV_{CES}/\Delta T_J$	$V_{GE} = 0\text{ V}, I_C = 500\text{ }\mu\text{A}$ (25 °C to 125 °C)	-	-8.5	-	V/°C
Collector to emitter voltage	$V_{CE(ON)}$	$V_{GE} = 15\text{ V}, I_C = 27\text{ A}$	-	2.45	2.8	V
		$V_{GE} = 15\text{ V}, I_C = 50\text{ A}$	-	2.73	3.2	
		$V_{GE} = 15\text{ V}, I_C = 27\text{ A}, T_J = 125\text{ }^\circ\text{C}$	-	2	2.35	
		$V_{GE} = 15\text{ V}, I_C = 50\text{ A}, T_J = 125\text{ }^\circ\text{C}$	-	2.43	2.9	
Gate threshold voltage	$V_{GE(th)}$	$V_{CE} = V_{GE}, I_C = 250\text{ }\mu\text{A}$	2.8	4.5	6.3	
Temperature coefficient of threshold voltage	$\Delta V_{GE(th)}/\Delta T_J$	$V_{CE} = V_{GE}, I_C = 1\text{ mA}$ (25 °C to 125 °C)	-	-11.7	-	mV/°C
Forward transconductance	g_{fe}	$V_{CE} = 20\text{ V}, I_C = 50\text{ A}$	-	68	-	s
Transfer characteristics	V_{GE}	$V_{CE} = 20\text{ V}, I_C = 50\text{ A}$	-	6.9	-	V
Zero gate voltage collector current	I_{CES}	$V_{GE} = 0\text{ V}, V_{CE} = 900\text{ V}$	-	0.006	0.38	mA
		$V_{GE} = 0\text{ V}, V_{CE} = 900\text{ V}, T_J = 125\text{ }^\circ\text{C}$	-	1.4	3	
Gate to emitter leakage current	I_{GES}	$V_{GE} = \pm 20\text{ V}, V_{CE} = 0\text{ V}$	-	-	± 200	nA
D1 - D2 CLAMPING DIODE						
Cathode to anode blocking voltage	V_{BR}	$I_R = 100\text{ }\mu\text{A}$	600	-	-	V
Forward voltage drop	V_{FM}	$I_F = 30\text{ A}$	-	1.84	2.12	
		$I_F = 30\text{ A}, T_J = 125\text{ }^\circ\text{C}$	-	1.37	1.65	
Reverse leakage current	I_{RM}	$V_R = 600\text{ V}$	-	0.002	0.1	mA
		$V_R = 600\text{ V}, T_J = 125\text{ }^\circ\text{C}$	-	0.9	6	
D3 - D4 AP DIODE						
Forward voltage drop	V_{FM}	$I_F = 50\text{ A}$	-	2.7	3.2	V
		$I_F = 50\text{ A}, T_J = 125\text{ }^\circ\text{C}$	-	2.8	3.3	
D5 - D6 AP DIODE						
Forward voltage drop	V_{FM}	$I_F = 30\text{ A}$	-	1.93	2.37	V
		$I_F = 30\text{ A}, T_J = 125\text{ }^\circ\text{C}$	-	1.48	1.9	



SWITCHING CHARACTERISTICS ($T_J = 25\text{ }^\circ\text{C}$ unless otherwise noted)						
PARAMETER	SYMBOL	TEST CONDITIONS	MIN.	TYP.	MAX.	UNITS
Q1 - Q4 IGBT (WITH FREEWHEELING D1 - D2 CLAMPING DIODE)						
Total gate charge (turn-on)	Q_g	$I_C = 70\text{ A}$	-	480	720	nC
Gate to emitter charge (turn-on)	Q_{ge}	$V_{CC} = 400\text{ V}$	-	82	164	
Gate to collector charge (turn-on)	Q_{gc}	$V_{GE} = 15\text{ V}$	-	160	260	
Turn-on switching loss	E_{ON}	$I_C = 50\text{ A}$ $V_{CC} = 400\text{ V}$ $V_{GE} = 15\text{ V}$ $R_g = 4.7\text{ }\Omega$ $L = 500\text{ }\mu\text{H}^{(1)}$	-	0.11	-	mJ
Turn-off switching loss	E_{OFF}		-	0.76	-	
Total switching loss	E_{TOT}		-	0.87	-	
Turn-on delay time	$t_{d(on)}$		-	182	-	ns
Rise time	t_r	-	46	-		
Turn-off delay time	$t_{d(off)}$	-	207	-		
Fall time	t_f	-	92	-		
Turn-on switching loss	E_{ON}	$I_C = 50\text{ A}$ $V_{CC} = 400\text{ V}$ $V_{GE} = 15\text{ V}$ $R_g = 4.7\text{ }\Omega$ $L = 500\text{ }\mu\text{H}$ $T_J = 125\text{ }^\circ\text{C}^{(1)}$	-	0.25	-	mJ
Turn-off switching loss	E_{OFF}		-	0.88	-	
Total switching loss	E_{TOT}		-	1.13	-	
Turn-on delay time	$t_{d(on)}$		-	183	-	ns
Rise time	t_r	-	47	-		
Turn-off delay time	$t_{d(off)}$	-	211	-		
Fall time	t_f	-	101	-		
Input capacitance	C_{ies}	$V_{GE} = 0\text{ V}$	-	9500		pF
Output capacitance	C_{oes}	$V_{CC} = 30\text{ V}$	-	780		
Reverse transfer capacitance	C_{res}	$f = 1\text{ MHz}$	-	116		
Reverse bias safe operating area	RBSOA	$T_J = 150\text{ }^\circ\text{C}$, $I_C = 150\text{ A}$ $V_{CC} = 400\text{ V}$, $V_P = 600\text{ V}$ $R_g = 22\text{ }\Omega$, $V_{GE} = 15\text{ V to } 0\text{ V}$	Fullsquare			
Q2 - Q3 IGBT (WITH FREEWHEELING D3 - D4 AP DIODE)						
Total gate charge (turn-on)	Q_g	$I_C = 50\text{ A}$	-	320	480	nC
Gate to emitter charge (turn-on)	Q_{ge}	$V_{CC} = 400\text{ V}$	-	38	58	
Gate to collector charge (turn-on)	Q_{gc}	$V_{GE} = 15\text{ V}$	-	106	160	
Turn-on switching loss	E_{ON}	$I_C = 50\text{ A}$ $V_{CC} = 720\text{ V}$ $V_{GE} = 15\text{ V}$ $R_g = 4.7\text{ }\Omega$ $L = 500\text{ }\mu\text{H}^{(1)}$	-	0.56	-	mJ
Turn-off switching loss	E_{OFF}		-	0.68	-	
Total switching loss	E_{TOT}		-	1.24	-	
Turn-on delay time	$t_{d(on)}$		-	152	-	ns
Rise time	t_r	-	48	-		
Turn-off delay time	$t_{d(off)}$	-	165	-		
Fall time	t_f	-	100	-		
Turn-on switching loss	E_{ON}	$I_C = 50\text{ A}$ $V_{CC} = 720\text{ V}$ $V_{GE} = 15\text{ V}$ $R_g = 4.7\text{ }\Omega$ $L = 500\text{ }\mu\text{H}$ $T_J = 125\text{ }^\circ\text{C}^{(1)}$	-	0.95	-	mJ
Turn-off switching loss	E_{OFF}		-	2.18	-	
Total switching loss	E_{TOT}		-	3.13	-	
Turn-on delay time	$t_{d(on)}$		-	154	-	ns
Rise time	t_r	-	52	-		
Turn-off delay time	$t_{d(off)}$	-	168	-		
Fall time	t_f	-	360	-		
Input capacitance	C_{ies}	$V_{GE} = 0\text{ V}$	-	6600	-	pF
Output capacitance	C_{oes}	$V_{CC} = 30\text{ V}$	-	400	-	
Reverse transfer capacitance	C_{res}	$f = 1\text{ MHz}$	-	90	-	
Reverse bias safe operating area	RBSOA	$T_J = 150\text{ }^\circ\text{C}$, $I_C = 150\text{ A}$ $V_{CC} = 720\text{ V}$, $V_P = 900\text{ V}$ $R_g = 22\text{ }\Omega$, $V_{GE} = 15\text{ V to } 0\text{ V}$	Fullsquare			



SWITCHING CHARACTERISTICS ($T_J = 25\text{ }^\circ\text{C}$ unless otherwise noted)						
PARAMETER	SYMBOL	TEST CONDITIONS	MIN.	TYP.	MAX.	UNITS
D1 - D2 CLAMPING DIODE						
Diode reverse recovery time	t_{rr}	$V_R = 200\text{ V}$ $I_F = 30\text{ A}$ $di/dt = 500\text{ A}/\mu\text{s}$	-	50	80	ns
Diode peak reverse current	I_{rr}		-	7.5	11	A
Diode recovery charge	Q_{rr}		-	185	440	nC
Diode reverse recovery time	t_{rr}	$V_R = 200\text{ V}$ $I_F = 30\text{ A}$ $di/dt = 500\text{ A}/\mu\text{s}, T_J = 125\text{ }^\circ\text{C}$	-	107	147	ns
Diode peak reverse current	I_{rr}		-	18	22	A
Diode recovery charge	Q_{rr}		-	955	1620	nC
D3 - D4 AP DIODE						
Diode reverse recovery time	t_{rr}	$V_R = 400\text{ V}$ $I_F = 50\text{ A}$ $di/dt = 500\text{ A}/\mu\text{s}$	-	114	150	ns
Diode peak reverse current	I_{rr}		-	21	25	A
Diode recovery charge	Q_{rr}		-	1200	1875	nC
Diode reverse recovery time	t_{rr}	$V_R = 400\text{ V}$ $I_F = 50\text{ A}$ $di/dt = 500\text{ A}/\mu\text{s}, T_J = 125\text{ }^\circ\text{C}$	-	170	210	ns
Diode peak reverse current	I_{rr}		-	28	32	A
Diode recovery charge	Q_{rr}		-	2160	3360	nC
D5 - D6 AP DIODE						
Diode reverse recovery time	t_{rr}	$V_R = 200\text{ V}$ $I_F = 30\text{ A}$ $di/dt = 500\text{ A}/\mu\text{s}$	-	46	77	ns
Diode peak reverse current	I_{rr}		-	7	11	A
Diode recovery charge	Q_{rr}		-	161	423	nC
Diode reverse recovery time	t_{rr}	$V_R = 200\text{ V}$ $I_F = 30\text{ A}$ $di/dt = 500\text{ A}/\mu\text{s}, T_J = 125\text{ }^\circ\text{C}$	-	106	138	ns
Diode peak reverse current	I_{rr}		-	17	22	A
Diode recovery charge	Q_{rr}		-	900	1518	nC

Note

(1) Energy losses include "tail" and diode reverse recovery.

THERMISTOR ELECTRICAL CHARACTERISTICS ($T_J = 25\text{ }^\circ\text{C}$ unless otherwise noted)						
PARAMETER	SYMBOL	TEST CONDITIONS	MIN.	TYP.	MAX.	UNITS
Resistance	R_{25}		4500	5000	5500	Ω
	R_{100}	$T_J = 100\text{ }^\circ\text{C}$	468	493	518	
B value	B	$T_J = 25\text{ }^\circ\text{C}/T_J = 50\text{ }^\circ\text{C}$	3206	3375	3544	K

THERMAL AND MECHANICAL SPECIFICATIONS						
PARAMETER	SYMBOL	MIN.	TYP.	MAX.	UNITS	
Q1 - Q4 IGBT - Junction to case thermal resistance (per switch)	R_{thJC}	-	-	0.37	$^\circ\text{C}/\text{W}$	
Q2 - Q3 IGBT - Junction to case thermal resistance (per switch)		-	-	0.37		
D1 - D2 Clamping diode - Junction to case thermal resistance (per diode)		-	-	0.83		
D3 - D4 AP diode - Junction to case thermal resistance (per diode)		-	-	0.71		
D5 - D6 AP diode - Junction to case thermal resistance (per diode)		-	-	1.3		
Q1 - Q4 IGBT - Case to sink thermal resistance (per switch)	$R_{thCS}^{(1)}$	-	0.31	-		
Q2 - Q3 IGBT - Case to sink thermal resistance (per switch)		-	0.31	-		
D1 - D2 Clamping diode - Case to sink thermal resistance (per diode)		-	0.51	-		
D3 - D4 AP diode - Case to sink thermal resistance (per diode)		-	0.41	-		
D5 - D6 AP diode - Case to sink thermal resistance (per diode)		-	0.62	-		
Mounting torque (M4)		2	-	3	Nm	
Weight		-	39	-	g	

Note

(1) Mounting surface flat, smooth, and greased

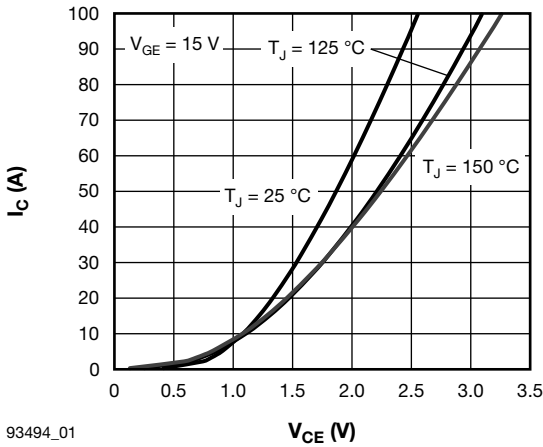

93494_01

Fig. 1 - Typical Q1 - Q4 IGBT Output Characteristics

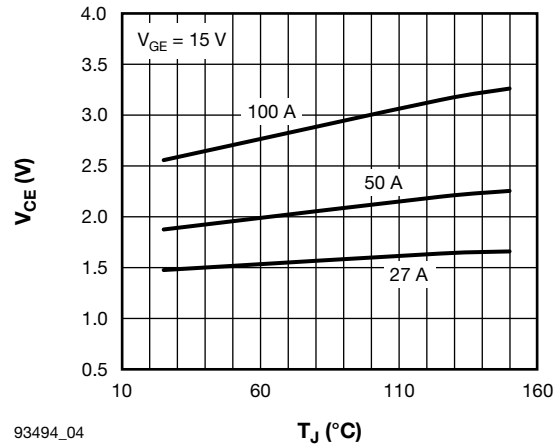

93494_04

Fig. 4 - Typical Q1 - Q4 IGBT Collector to Emitter Voltage vs. Junction Temperature

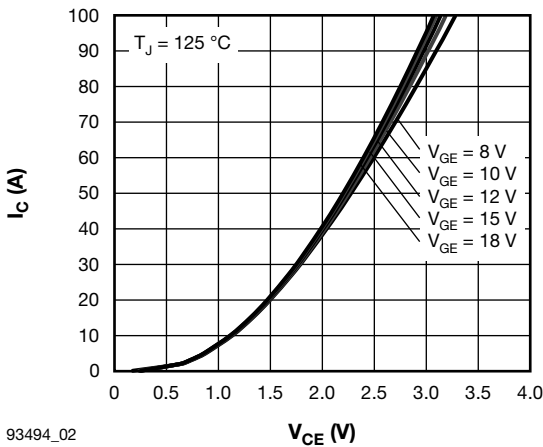

93494_02

Fig. 2 - Typical Q1 - Q4 IGBT Output Characteristics

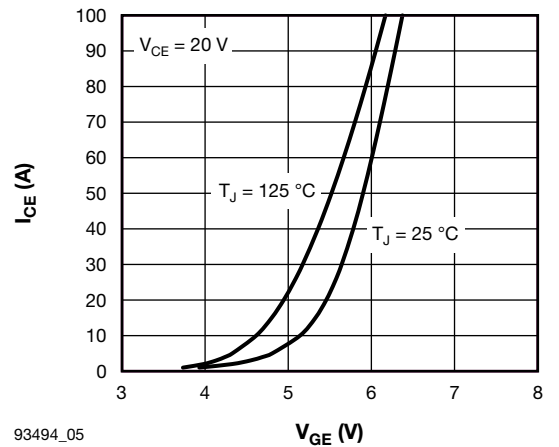

93494_05

Fig. 5 - Typical Q1 - Q4 IGBT Transfer Characteristics

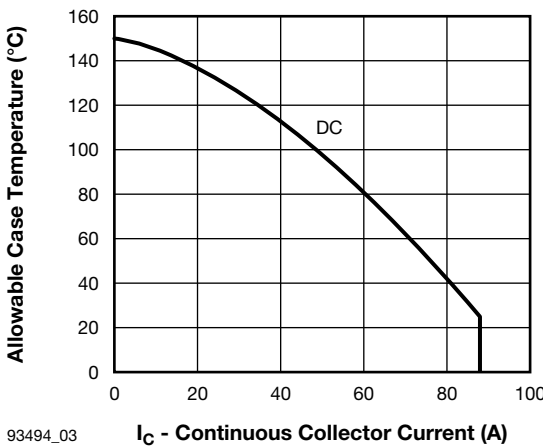

93494_03

Fig. 3 - Maximum DC Q1 - Q4 IGBT Collector Current vs. Case Temperature per Junction

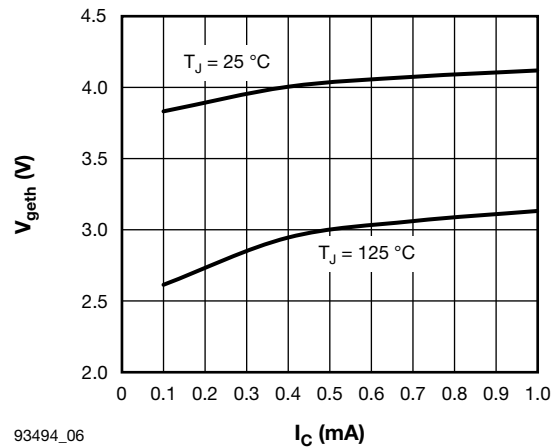

93494_06

Fig. 6 - Typical Q1 - Q4 IGBT Gate Threshold Voltage

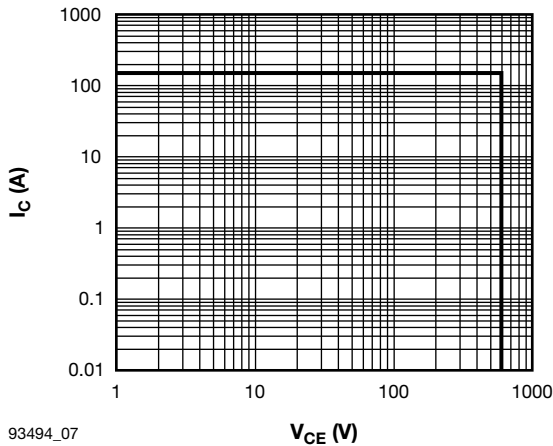

93494_07

Fig. 7 - Q1 - Q4 IGBT Reverse Bias SOA
 $T_J = 150\text{ }^\circ\text{C}$, $V_{GE} = 15\text{ V}$, $R_g = 22\text{ }\Omega$

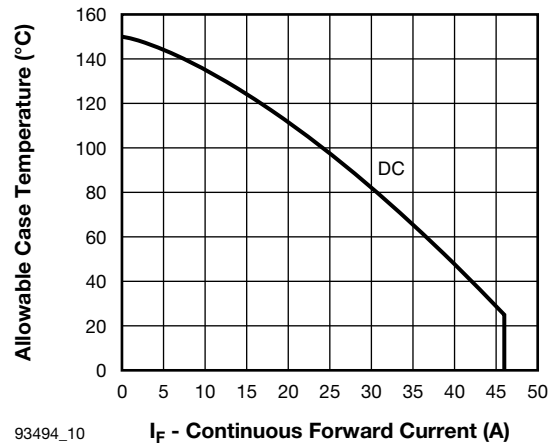

93494_10

Fig. 10 - Maximum DC D5 - D6 Antiparallel Diode Forward Current vs. Case Temperature per Junction

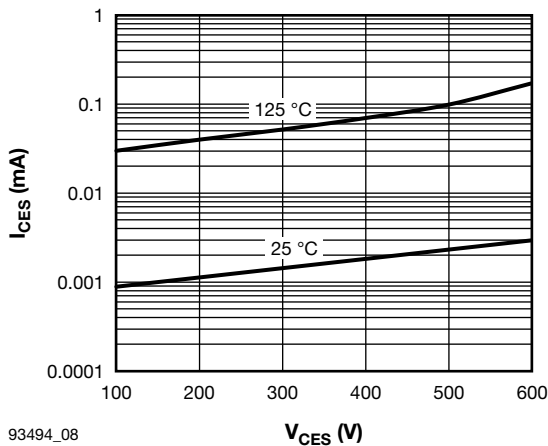

93494_08

Fig. 8 - Typical Q1 - Q4 IGBT Zero Gate Voltage Collector Current

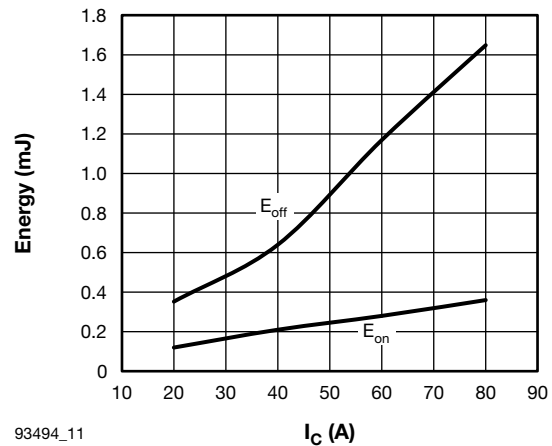

93494_11

Fig. 11 - Typical Q1 - Q4 IGBT Energy Loss vs. I_C (with Freewheeling D1 - D2 Clamping Diode)
 $V_{CC} = 400\text{ V}$, $R_g = 4.7\text{ }\Omega$, $V_{GE} = 15\text{ V}$, $L = 500\text{ }\mu\text{H}$

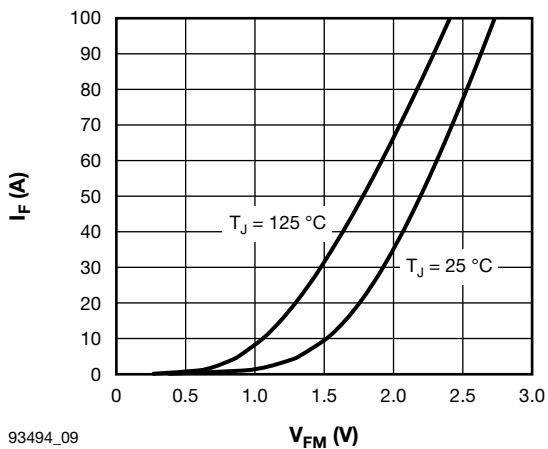

93494_09

Fig. 9 - Typical D5 - D6 Antiparallel Diode Forward Characteristics

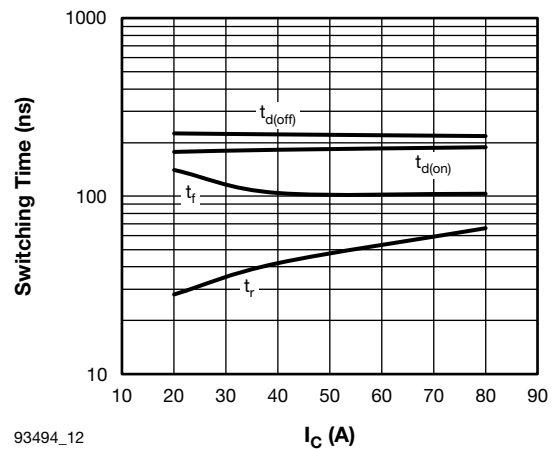

93494_12

Fig. 12 - Typical Q1 - Q4 IGBT Switching Time vs. I_C (with Freewheeling D1 - D2 Clamping Diode)
 $T_J = 125\text{ }^\circ\text{C}$, $V_{CC} = 400\text{ V}$, $R_g = 4.7\text{ }\Omega$, $V_{GE} = 15\text{ V}$, $L = 500\text{ }\mu\text{H}$

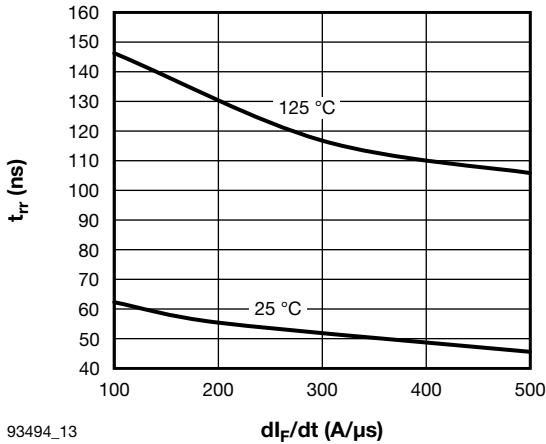

93494_13

Fig. 13 - Typical D5 - D6 Antiparallel Diode Reverse Recovery Time vs. di_F/dt
 $V_R = 200\text{ V}$, $I_F = 30\text{ A}$

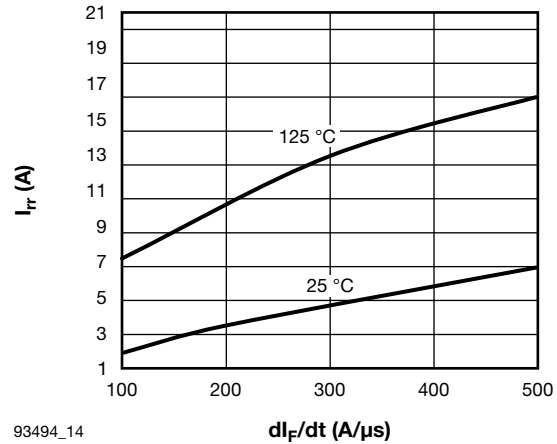

93494_14

Fig. 14 - Typical D5 - D6 Antiparallel Diode Reverse Recovery Current vs. di_F/dt
 $V_R = 200\text{ V}$, $I_F = 30\text{ A}$

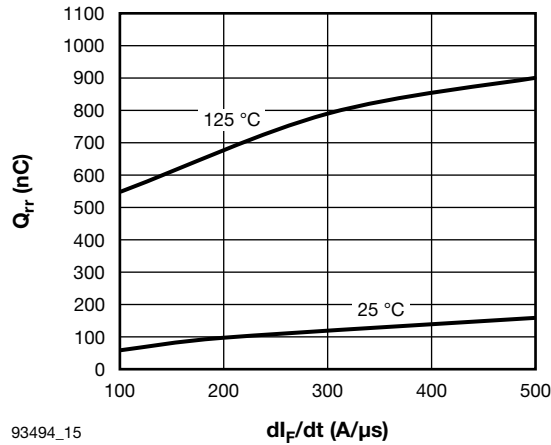

93494_15

Fig. 15 - Typical D5 - D6 Antiparallel Diode Reverse Recovery Charge vs. di_F/dt
 $V_R = 200\text{ V}$, $I_F = 30\text{ A}$

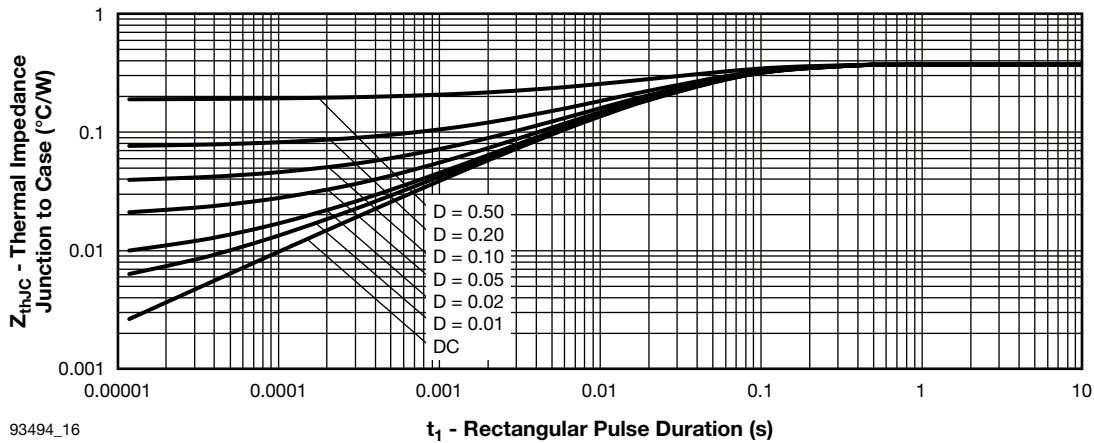

93494_16

Fig. 16 - Maximum Thermal Impedance Z_{thJC} Characteristics (Q1 - Q4 IGBT)

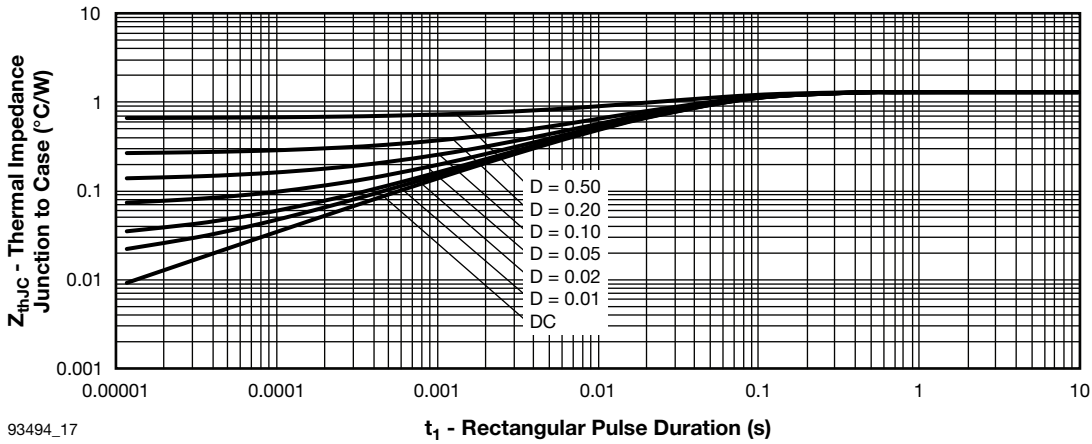

Fig. 17 - Maximum Thermal Impedance Z_{thJC} Characteristics (D5 - D6 Antiparallel Diode)

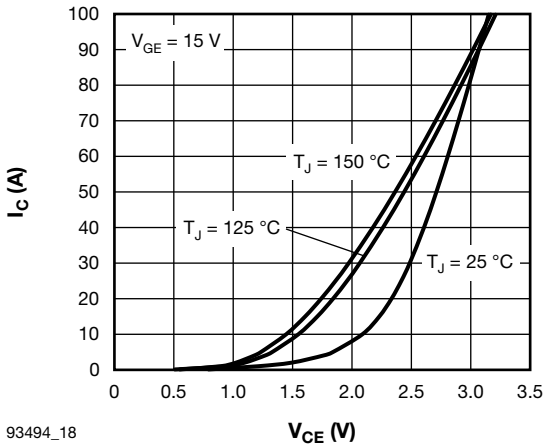

Fig. 18 - Typical Q2 - Q3 IGBT Output Characteristics

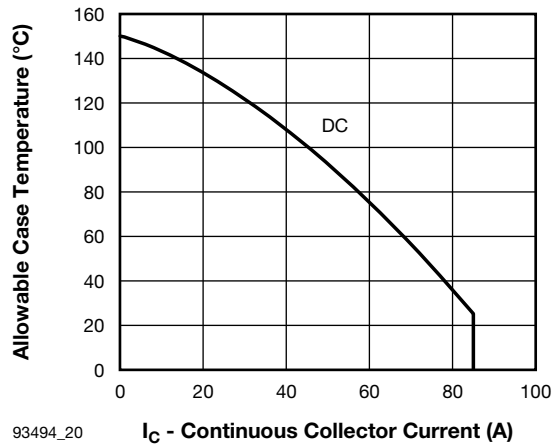

Fig. 20 - Maximum DC Q2 - Q3 IGBT Collector Current vs. Case Temperature per Junction

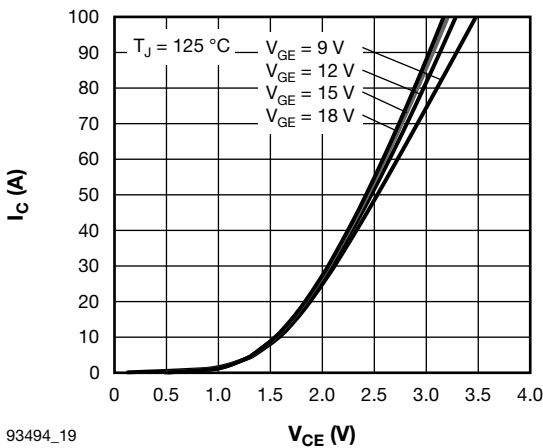

Fig. 19 - Typical Q2 - Q3 IGBT Output Characteristics

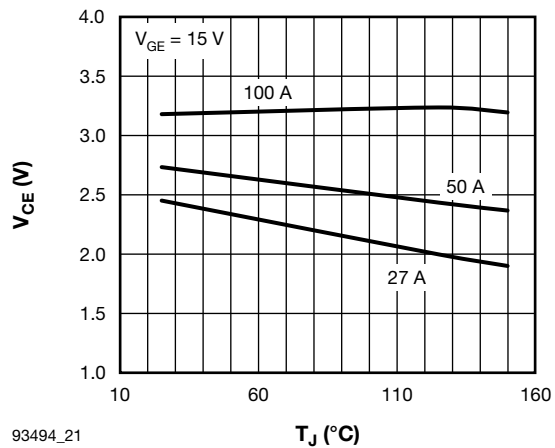
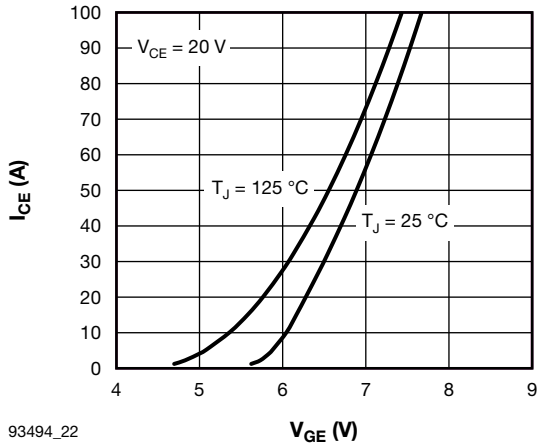
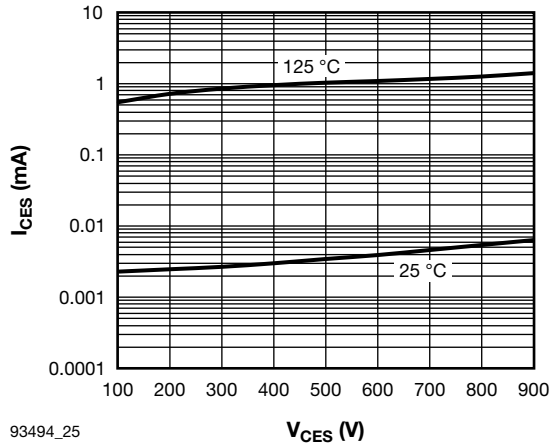

Fig. 21 - Typical Q2 - Q3 IGBT Collector to Emitter Voltage vs. Junction Temperature



93494_22
Fig. 22 - Typical Q1 - Q4 IGBT Transfer Characteristics



93494_25
Fig. 25 - Typical Q2 - Q3 IGBT Zero Gate Voltage Collector Current

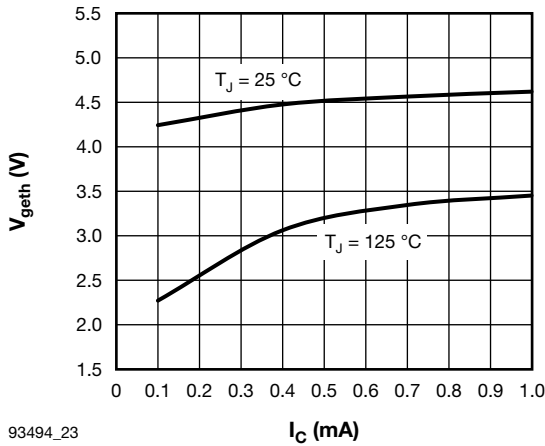

93494_23
Fig. 23 - Typical Q2 - Q3 IGBT Gate Threshold Voltage

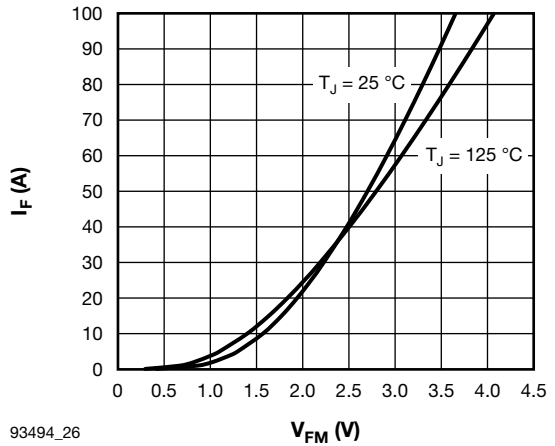

93494_26
Fig. 26 - Typical D3 - D4 Antiparallel Diode Forward Characteristics

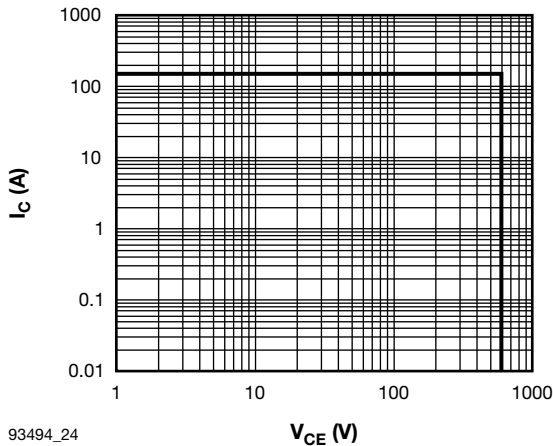

93494_24
Fig. 24 - Q2 - Q3 IGBT Reverse Bias SOA
 $T_J = 150\text{ °C}$, $V_{GE} = 15\text{ V}$, $R_g = 22\ \Omega$

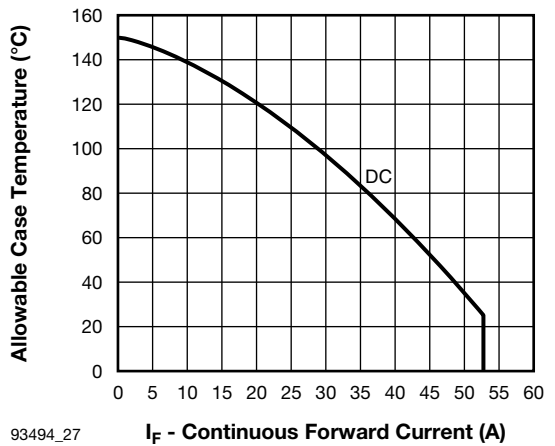

93494_27
Fig. 27 - Maximum DC D3 - D4 Antiparallel Diode Forward Current vs. Case Temperature per Junction

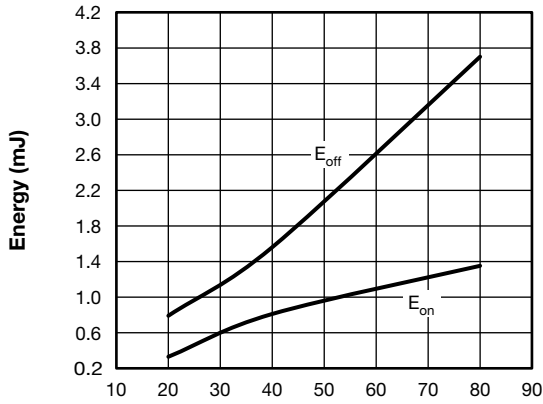

93494_28

I_C (A)

Fig. 28 - Typical Q2 - Q3 IGBT Energy Loss vs. I_C (with Freewheeling D2 - D3 AP Diode)
V_{CC} = 720 V, R_g = 4.7 Ω, V_{GE} = 15 V, L = 500 μH

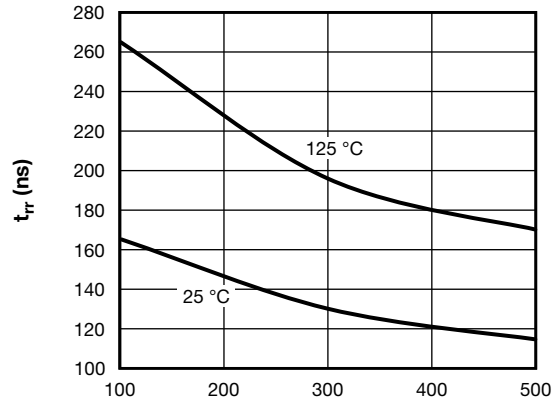

93494_30

di_F/dt (A/μs)

Fig. 30 - Typical D3 - D4 Antiparallel Diode Reverse Recovery Time vs. di_F/dt
V_R = 400 V, I_F = 50 A

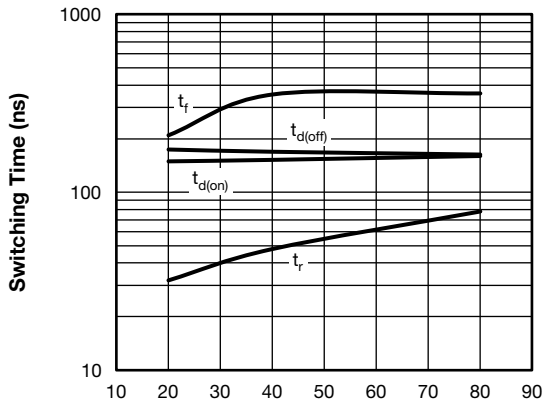

93494_29

I_C (A)

Fig. 29 - Typical Q2 - Q3 IGBT Switching Time vs. I_C (with Freewheeling D2 - D3 AP Diode)
T_J = 125 °C, V_{CC} = 720 V, R_g = 4.7 Ω, V_{GE} = 15 V, L = 500 μH

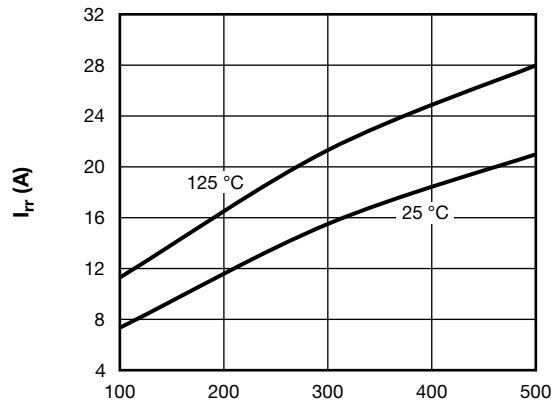

93494_31

di_F/dt (A/μs)

Fig. 31 - Typical D3 - D4 Antiparallel Diode Reverse Recovery Current vs. di_F/dt
V_R = 400 V, I_F = 50 A

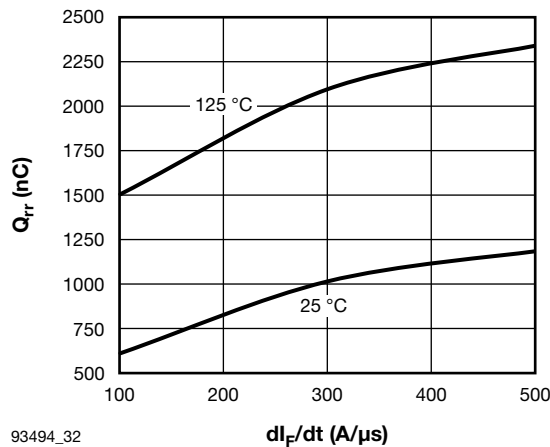

93494_32

di_F/dt (A/μs)

Fig. 32 - Typical D3 - D4 Antiparallel Diode Reverse Recovery Charge vs. di_F/dt
V_R = 400 V, I_F = 50 A

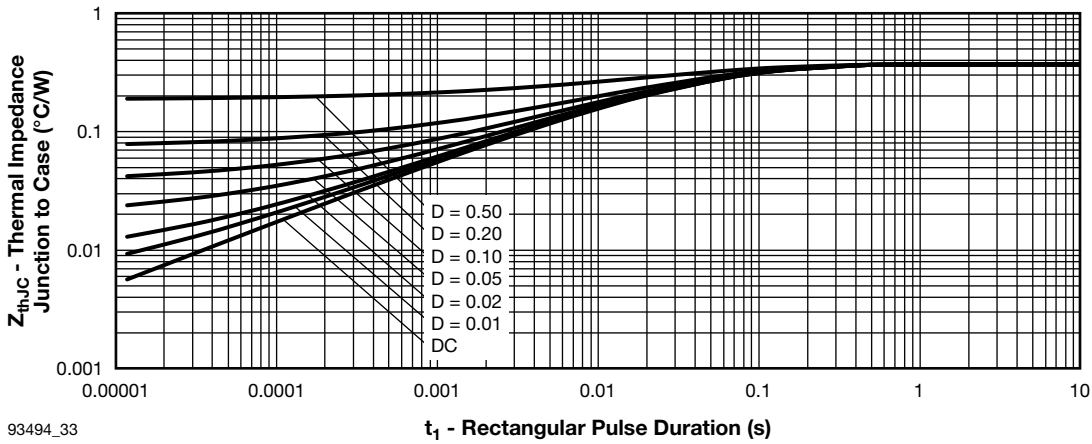

Fig. 33 - Maximum Thermal Impedance Z_{thJC} Characteristics (Q2 - Q3 IGBT)

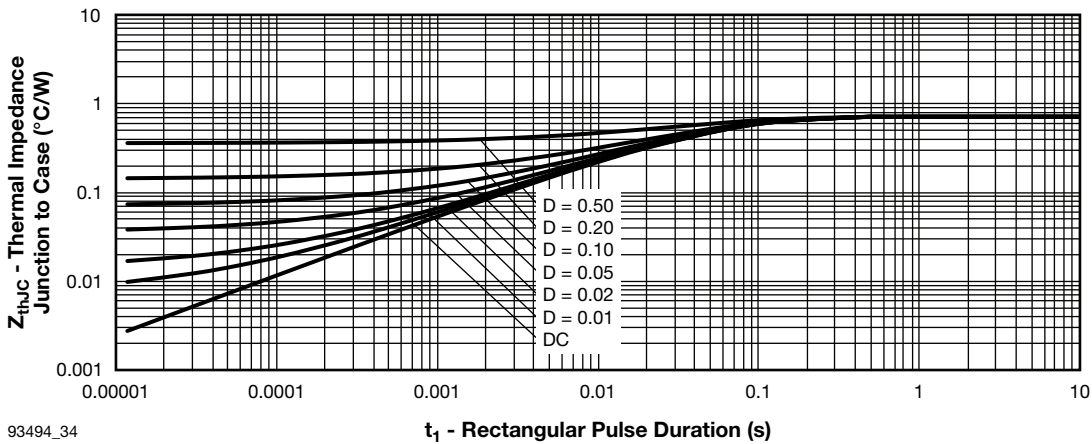

Fig. 34 - Maximum Thermal Impedance Z_{thJC} Characteristics (D3 - D4 Antiparallel Diode)

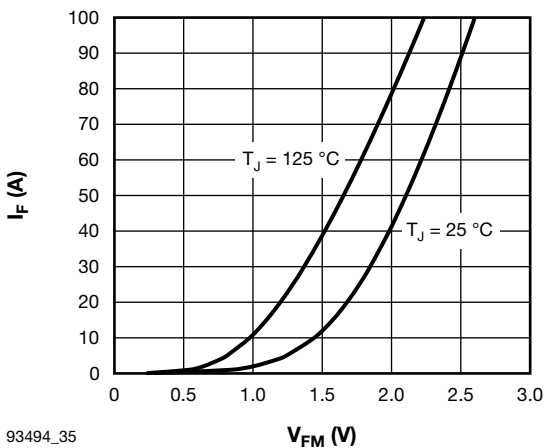

Fig. 35 - Typical D1 - D2 Clamping Diode Forward Characteristics

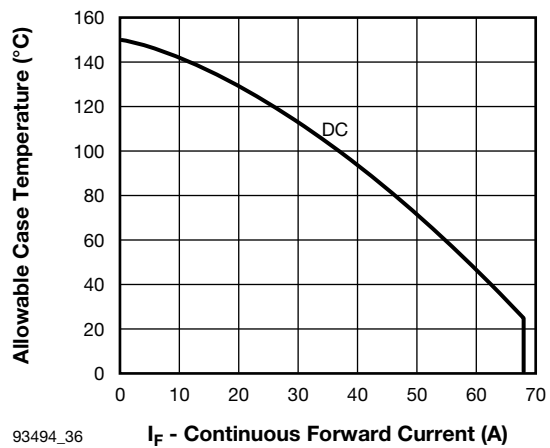
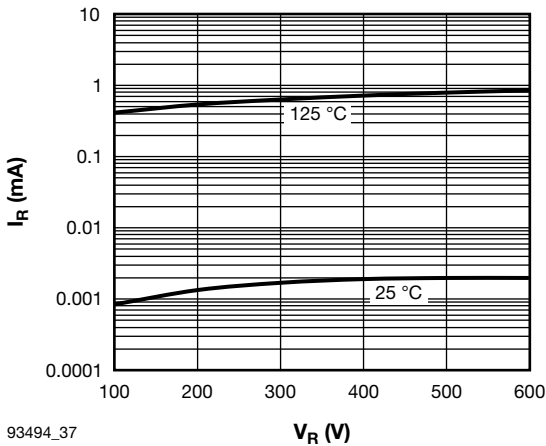
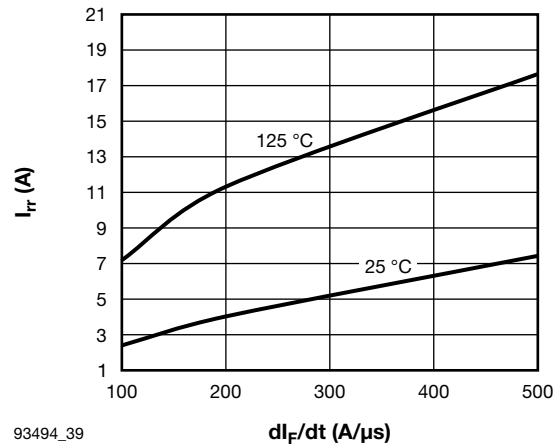

Fig. 36 - Maximum DC D1 - D2 Clamping Diode Forward Current vs. Case Temperature per Junction



93494_37

Fig. 37 - Typical D1 - D2 Clamping Diode Reverse Leakage Current



93494_39

Fig. 39 - Typical D1 - D2 Clamping Diode Reverse Recovery Current vs. di_F/dt
 $V_R = 200\text{ V}$, $I_F = 30\text{ A}$

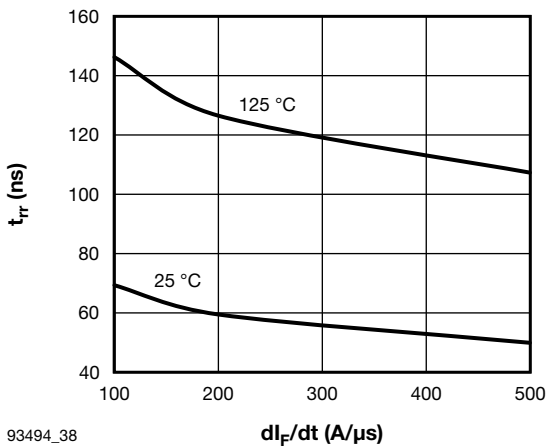

93494_38

Fig. 38 - Typical D1 - D2 Clamping Diode Reverse Recovery Time vs. di_F/dt
 $V_R = 200\text{ V}$, $I_F = 30\text{ A}$

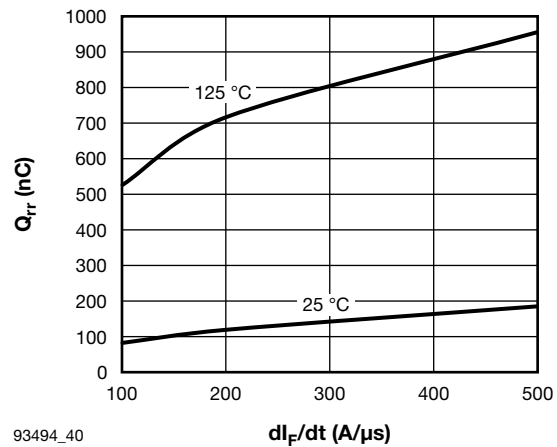

93494_40

Fig. 40 - Typical D1 - D2 Clamping Diode Reverse Recovery Charge vs. di_F/dt
 $V_R = 200\text{ V}$, $I_F = 30\text{ A}$

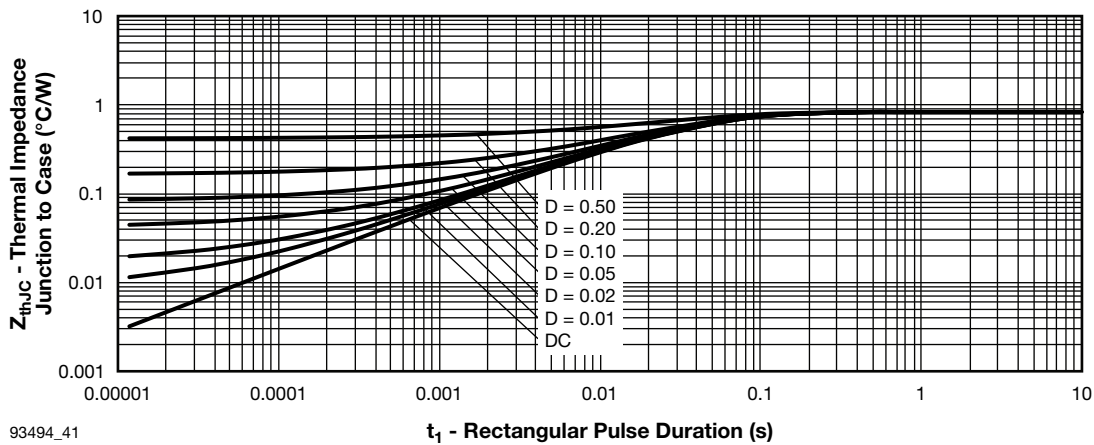

93494_41

Fig. 41 - Maximum Thermal Impedance Z_{thJC} Characteristics (D1 - D2 Clamping Diode)

ORDERING INFORMATION TABLE

Device code	VS-	EM	F	050	J	60	U
	①	②	③	④	⑤	⑥	⑦

- 1** - Vishay Semiconductors product
- 2** - Package indicator (EM = EMIPAK2)
- 3** - Circuit configuration (F = 3-levels half-bridge inverter stage)
- 4** - Current rating (050 = 50 A)
- 5** - Die technology (J = Warp2 IGBT)
- 6** - Voltage rating (60 = 600 V)
- 7** - U = Ultrafast

TYPICAL CONNECTION

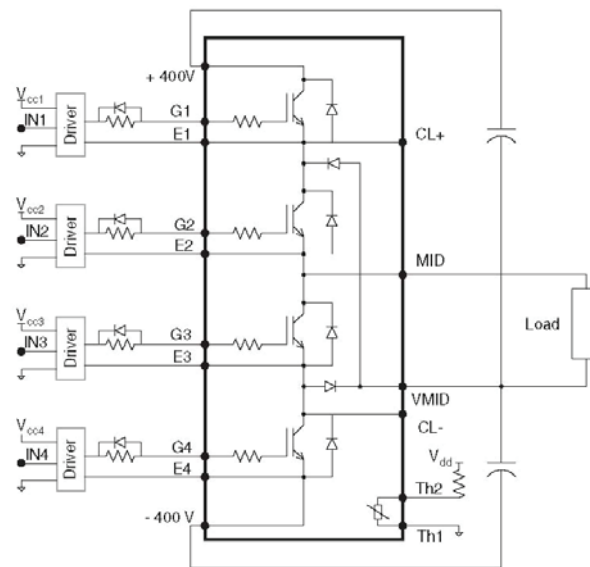

Note

- Please refer to lead assignment for correct pin configuration. This diagram shows electrical connections only.

CIRCUIT CONFIGURATION

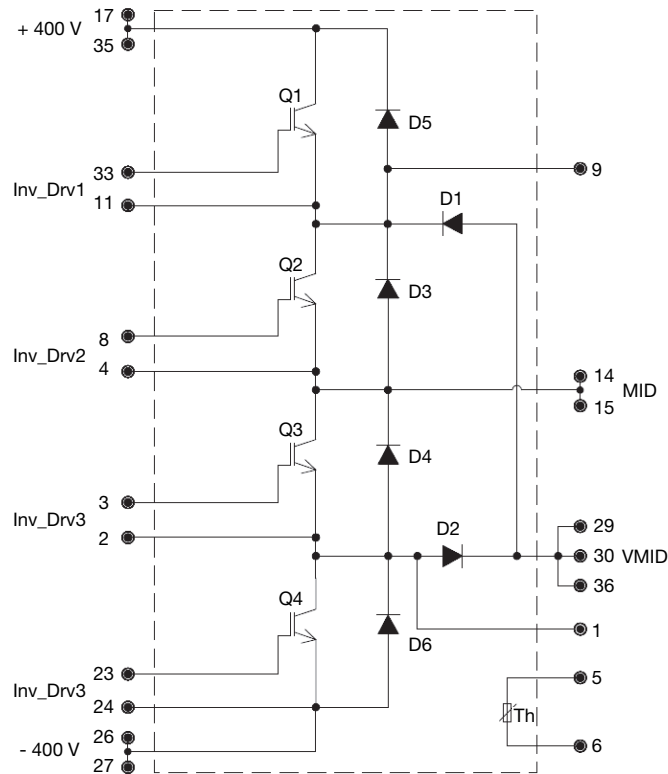

PACKAGE

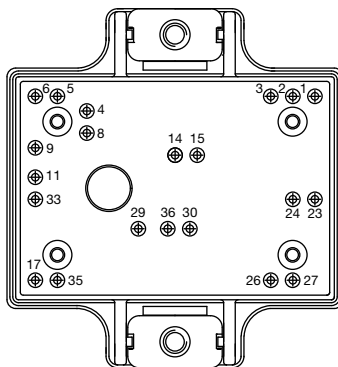

LINKS TO RELATED DOCUMENTS

Dimensions	www.vishay.com/doc?95436
------------	--

EMIPAK2

DIMENSIONS in millimeters

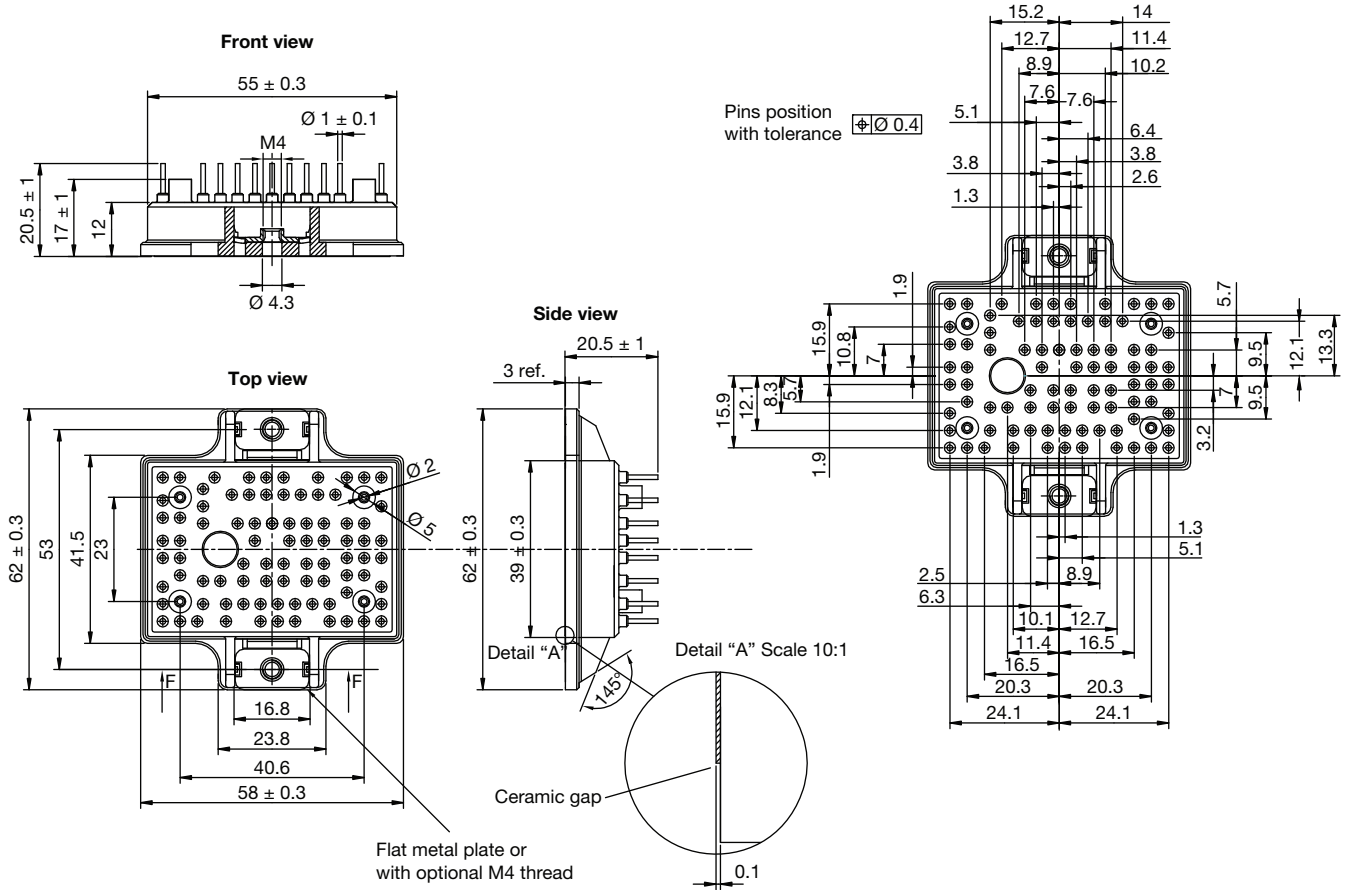



Disclaimer

ALL PRODUCT, PRODUCT SPECIFICATIONS AND DATA ARE SUBJECT TO CHANGE WITHOUT NOTICE TO IMPROVE RELIABILITY, FUNCTION OR DESIGN OR OTHERWISE.

Vishay Intertechnology, Inc., its affiliates, agents, and employees, and all persons acting on its or their behalf (collectively, "Vishay"), disclaim any and all liability for any errors, inaccuracies or incompleteness contained in any datasheet or in any other disclosure relating to any product.

Vishay makes no warranty, representation or guarantee regarding the suitability of the products for any particular purpose or the continuing production of any product. To the maximum extent permitted by applicable law, Vishay disclaims (i) any and all liability arising out of the application or use of any product, (ii) any and all liability, including without limitation special, consequential or incidental damages, and (iii) any and all implied warranties, including warranties of fitness for particular purpose, non-infringement and merchantability.

Statements regarding the suitability of products for certain types of applications are based on Vishay's knowledge of typical requirements that are often placed on Vishay products in generic applications. Such statements are not binding statements about the suitability of products for a particular application. It is the customer's responsibility to validate that a particular product with the properties described in the product specification is suitable for use in a particular application. Parameters provided in datasheets and/or specifications may vary in different applications and performance may vary over time. All operating parameters, including typical parameters, must be validated for each customer application by the customer's technical experts. Product specifications do not expand or otherwise modify Vishay's terms and conditions of purchase, including but not limited to the warranty expressed therein.

Except as expressly indicated in writing, Vishay products are not designed for use in medical, life-saving, or life-sustaining applications or for any other application in which the failure of the Vishay product could result in personal injury or death. Customers using or selling Vishay products not expressly indicated for use in such applications do so at their own risk. Please contact authorized Vishay personnel to obtain written terms and conditions regarding products designed for such applications.

No license, express or implied, by estoppel or otherwise, to any intellectual property rights is granted by this document or by any conduct of Vishay. Product names and markings noted herein may be trademarks of their respective owners.

Material Category Policy

Vishay Intertechnology, Inc. hereby certifies that all its products that are identified as RoHS-Compliant fulfill the definitions and restrictions defined under Directive 2011/65/EU of The European Parliament and of the Council of June 8, 2011 on the restriction of the use of certain hazardous substances in electrical and electronic equipment (EEE) - recast, unless otherwise specified as non-compliant.

Please note that some Vishay documentation may still make reference to RoHS Directive 2002/95/EC. We confirm that all the products identified as being compliant to Directive 2002/95/EC conform to Directive 2011/65/EU.

Vishay Intertechnology, Inc. hereby certifies that all its products that are identified as Halogen-Free follow Halogen-Free requirements as per JEDEC JS709A standards. Please note that some Vishay documentation may still make reference to the IEC 61249-2-21 definition. We confirm that all the products identified as being compliant to IEC 61249-2-21 conform to JEDEC JS709A standards.