



DATASHEET

SM220 Module

©2008-2020 Synapse Wireless, All Rights Reserved. All Synapse products are patent pending. Synapse, the Synapse logo, SNAP, and Portal are all registered trademarks of Synapse Wireless, Inc.

Doc# 116-031507-001-G002

6723 Odyssey Drive // Huntsville, AL 35806 // (877) 982-7888 // Synapsewireless.com

SNAP Engine SM220 Modules Overview

The SNAP Engine Model SM220 series consists of the SM220UF1 part number. It is an IEEE 802.15.4, low-power, highly reliable solution for embedded wireless control and monitoring networks requiring high data rates. It embeds Synapse's SNAP OS, the industry's first Internet-enabled, wireless mesh network operating system, into the Atmel ATmega128RFA1 single-chip AVR[®] microcontroller with an integrated transceiver that delivers up to 2Mbps/sec. This low-cost module can have current consumption under 390nA to better enable battery-driven systems. The SM220 also includes a Skyworks SE2431L front-end module, which provides a power amplifier and LNA for increased range.

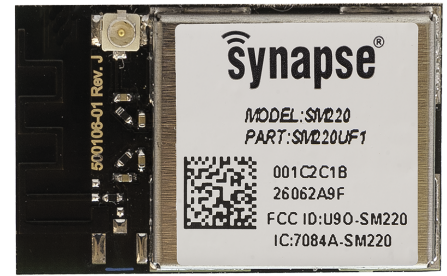

SNAP's on-board Python interpreter provides rapid application development and over-the-air programming, while Atmel's low-power RF single-chip design saves board space and lowers power consumption. The modules provide up to 15 channels of operation in the ISM 2.4GHz frequency band.

By default, the SNAP operating system automatically forms a mesh network with other nodes immediately on receiving power. No further configuration is necessary. Multiple unrelated SNAP networks can exist within the same area through several configuration options outlined in the SNAP User Guide available from www.synapse-wireless.com.

NOTE: Channel 15 is receive-only due to FCC power restrictions.

This data sheet covers part number **SM220UF1**:

- 32 GPIO with up to 7 A/D inputs
- 128k flash, 58.5k free for over-the-air uploaded user apps
- Two UART ports for control or transparent data
- Low power modes:
 - Timed Sleep Mode 1 : 1.27 μ A
 - Timed Sleep Mode 2 : 1.47 μ A
 - Untimed Sleep Mode : < 390 nA
- Spread Spectrum (DSSS) technology
- Up to 2 Mbps radio data rate
- 2.4 GHz RF Frequency
- AES 128-bit encryption
- Integrated on-board compact F antenna or U.FL connector
- Surface Mount, Solder-able
- 4K internal EEPROM

- 8 PWM outputs
- Supports over the air firmware upgrades.
(This process is further defined in the Portal User Guide.)

SM220 – Surface Mount Module

The SM220 is a surface mount module based on the ATmega128RFA1 chip. All the details appropriate for the chip-based version of ATmega128RFA1 SNAP apply to the SM220, with the following additions and exceptions. Pin numbers below refer to the pad on the SM220 footprint, with is a 64-pin arrangement of eight rows ("A" through "H") by eight columns ("1" - "8"). To reference IO pins in your code, use the SNAPpy IO number from the table below.

Form Factor

The SM220 is in a surface mount form-factor. The pad arrangement is shown below.

A1	A2	A3	A4	A5	A6	A7	A8
B1	B2	B3	B4	B5	B6	B7	B8
C1	C2	C3	C4	C5	C6	C7	C8
D1	D2	D3	D4	D5	D6	D7	D8
E1	E2	E3	E4	E5	E6	E7	E8
F1	F2	F3	F4	F5	F6	F7	F8
G1	G2	G3	G4	G5	G6	G7	G8
H1	H2	H3	H4	H5	H6	H7	H8

BOTTOM VIEW

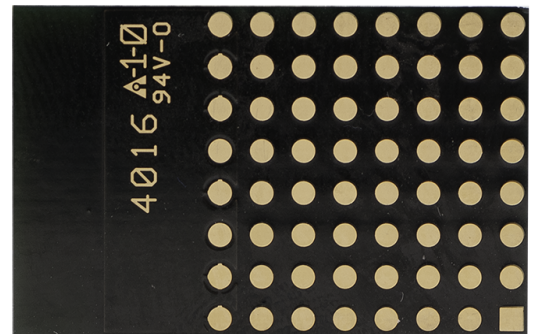

The pad designators "A1" through "H8" will be used throughout the remainder of this document.

Specifications

Table 1.1: SM220 Specifications at 23° C and 3.3V unless otherwise noted

Performance	Outdoor LOS Range	1 mile using u.fl antenna
	Transmit Power Output	up to +20 dBm
	RF Data Rate	250Kbps, 500Kbps, 1Mbps, 2Mbps
	Receiver Sensitivity	-103 dBm (1% PER, 250Kbps)
Power Requirements	Supply Voltage	2.0 - 3.6 V
	Transmit Current (Typ@3.3V)	at +20 dBm: 150 mA at +6 dBm: 55 mA
	Idle/Receive On (Typ@3.3V)	22 mA
	Idle/Receive Off (Typ@3.3V)	7.8 mA
	Sleep Mode Current (Typ@3.3V)	Timed Sleep: 1.27 μ A Untimed Sleep Mode : 390 nA
General	Frequency	ISM 2.4 GHz
	Spreading Method	Direct Sequence (DSSS)
	Modulation	O-QPSK
	Dimensions	29.8mm x 19mm
	Operating Temperature	- 40 to 85 deg C.
	Antenna Options	U.FL and on-board compact F antenna
	Weight	3 grams
Networking	Topology	SNAP
	Error Handling	Retries and acknowledgement
	Number of Channels	15 fully operational channels. To avoid exceeding FCC limits, channel 15 operates in a receive only state.

Available I/O	UARTS with optional HW Flow Control	2 Ports
	GPIO	32 total; 7 can be analog-in with 10bit ADC
Agency Approvals	FCC Part 15.247	FCC ID: U90-SM220
	Industry Canada (IC)	7084A-SM220

SM220 Module Pin Definitions

For pin locations, consult the SM220 Mechanical drawing later in this document.

Table 1.2: SM220UF1 Pin Assignments

SM220 Pin	SNAPpy IO	Pin Name	Pin Description
A1	-	GND	Power Supply
A2	-	VCC	Power Supply
A3	-	VCC	Power Supply
A4	24	PF0_ADC0	IO or Analog0
A5	26	PF2_ADC2_DIG2	IO or Analog2 or software SPI CLK ¹
A6	28	PF4_ADC4_TCK	IO or Analog4 or JTAG Test Clock
A7	30	PF6_ADC6_TDO	IO or Analog6 or JTAG Test Data Out or software I ² C ¹ SDA
A8	-	GND	Power Supply
B1	18	PE2_XCK0_AIN0	IO or software SPI ¹ MISO or Analog Comparator or External Clock
B2	19	PE3_OC3A_AIN1	IO or Analog Comparator or PWM or Output Compare Match
B3	21	PE5_OC3C_INT5	IO or UART0 RTS Input or PWM or Interrupt
B4	25	PF1_ADC1	IO or Analog1 or software SPI ¹ MOSI
B5	-	Test Point - Do Not Use	
B6	29	PF5_ADC5_TMS	IO or Analog5 or JTAG Test Mode Select

¹ Software generated SPI and I²C functions.

SM220 Pin	SNAPpy IO	Pin Name	Pin Description
B7	31	PF7_ADC7_TDI	IO or Analog7 or JTAG Test Data In or software I ² C ¹ SCL
B8	-	GND	Power Supply
C1	16	PE0_RXD0_PDI_PCINT8	IO or UART0 Data In or Interrupt
C2	17	PE1_TXD0_PDO	IO or UART0 Data Out
C3	20	PE4_OC3B_INT4	IO or UART0 CTS Output or PWM or Interrupt
C4	22	PE6_T3_INT6	IO or Interrupt
C5	23	PE7_ICP3_INT7_CLK0	IO or UART1 RTS input or Clock Output Buffer or Interrupt
C6	-	NC	Test Point - Do not use
C7	-	NC	
C8	-	NC	Test Point - Do not use
D1	5	PB5_OC1A_PCINT5	IO or PWM or Interrupt
D2	6	PB6_OC1B_PCINT6	IO or PWM or Interrupt
D3	7	PB7_OC0A_OC1C_PCINT7	IO or PWM or Interrupt
D4	-	NC	
D5	-	NC	
D6	-	NC	
D7	-	NC	
D8	-	GND	Power Supply
E1	2	PB2_MOSI_PCINT2 ²	IO or Interrupt
E2	3	PB3_MISO_PCINT3 ²	IO or Interrupt
E3	4	PB4_OC2A_PCINT4	IO or PWM or Interrupt
E4	-	NC	
E5	-	NC	

² These pins have special SPI hardware that is not natively supported by SNAP. You can use PEEK and POKE to initiate and enable this hardware functionality, but it is not supported by Synapse and we cannot guarantee your results.

SM220 Pin	SNAPpy IO	Pin Name	Pin Description
E6	-	NC	
E7	-	NC	
E8	-	NC	
F1	0	PB0_SSN_PCINT0 ²	IO or Interrupt
F2	1	PB1_SCK_PCINT1 ²	IO or Interrupt
F3	9	PD1_SDA_INT1 ³	IO or Interrupt
F4	8	PD0_SCL_INT0 ³	IO or Interrupt
F5	-	Test Point - Do Not Use	
F6	-	Test Point - Do Not Use	
F7	-	NC	
F8	-	GND	Power Supply
G1	-	CLKI	(Internal 1K pulldown)
G2	15	PD7_T0	IO
G3	12	PD4_ICP1	IO or UART1 CTS output or Input Capture
G4	10	PD2_RXD1_INT2	IO or UART1 Data In or Interrupt
G5	37	PG5_OC0B	IO or PWM
G6	-	NC	
G7	-	NC	
G8	-	GND	Power Supply
H1	-	GND	Power Supply
H2	14	PD6_T1	IO or Timer/Counter1 clock input
H3	13	PD5_XCK1	IO
H4	11	PD3_TXD1_INT3	IO or UART1 Data Out or Interrupt
H5	-	RESET#	Module Reset, Active Low
H6	-	NC	

³ These pins have special I²C hardware that is not natively supported by SNAP. You can use PEEK and POKE to initiate and enable this hardware functionality, but it is not supported by Synapse and we cannot guarantee your results.

SM220 Pin	SNAPpy IO	Pin Name	Pin Description
H7	-	NC	
H8	-	GND	Power Supply

You must preserve access to UART1 as a serial connection in order to be able to serially update firmware on the node, or to recover the node by forced script removal or parameter reset.

As a convenience, here is a cross reference from SM220 pad back to SNAPpy IO.

Table 1.3: SM220/SNAPpy IO Cross Reference

Pad	SNAPpy IO
A4	24
A5	26
A6	28
A7	30
B1	18
B2	19
B3	21
B4	25
B6	29
B7	31
C1	16
C2	17
C3	20
C4	22
C5	23
D1	5

Pad	SNAPpy IO
D2	6
D3	7
E1	2
E2	3
E3	4
F1	0
F2	1
F3	9
F4	8
G2	15
G3	12
G4	10
G5	37
H2	14
H3	13
H4	11

Electrical Characteristics

Unless otherwise specified in this document, all electrical characteristics conform to the Atmel ATmega 128RFA1 microcontroller. Detailed specifications on all electrical characteristics are available on the Atmel website at

<http://www.atmel.com/>

Table 1.4: SM220 DC Characteristics at 25° C

Symbol	Parameter	Condition	Min	Typ	Max	Units
V_{CC}^4	Supply Voltage		2.0	3.3	3.6	V

Table 1.5: ADC Electrical Characteristics (Operating)

Symbol	Parameter	Condition	Min	Typical	Max	Unit
V_{REFH}^5	ADC Voltage Reference, High	Programmable	1.5	1.6	1.8	V
V_{INDC}	Analog input voltage	Single Ended	0		1.8	V
		Differential ⁶	0		3.3	

Mechanical Drawings

SM220UF1 Mechanical Drawing on page **9** and **Block diagram showing the major subsystems comprising Model SM220** on page **10** show the modules with the compact F antenna and U.FL Connector options.

NOTE: The area under and around the module’s antenna (marked KEEP OUT AREA and tinted red) should have no components and no copper on any layer of the printed circuit board. Additionally, leave enough clearance around the module for worst case component and processing variances.

For best performance, the module should be mounted on the outside edge of the circuit board with the antenna side as close to the edge of the board as possible.

⁴ Absolute maximum stress rated voltage for VCC is -0.3 to 3.6. It is recommended that bulk capacitance be located as close as possible to the VCC pin on the host board. Ideally, use a single 47µF capacitor rated at 10V directly at the VCC pin.

⁵ VREFH is programmable to three fixed values; 1.5V, 1.6V, and 1.8V. The VREFH value will be 1.6 volts if you do not explicitly adjust it by poking the ATmega128RFA1 registers.

⁶ Each differential analog input may be as high as 3.3V but the single-ended voltage is still limited to the voltage reference.

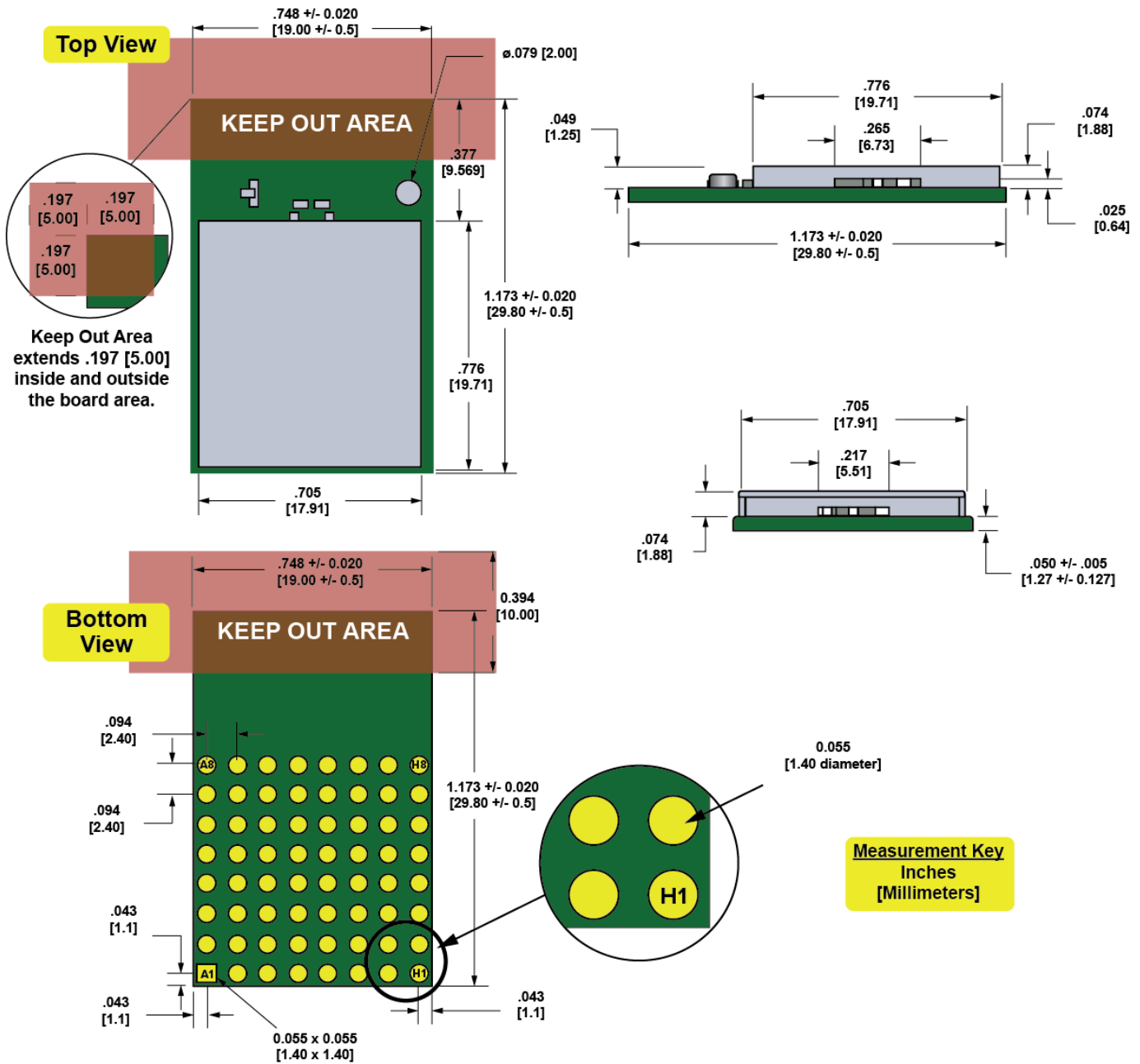

Figure 1.1: SM220UF1 Mechanical Drawing

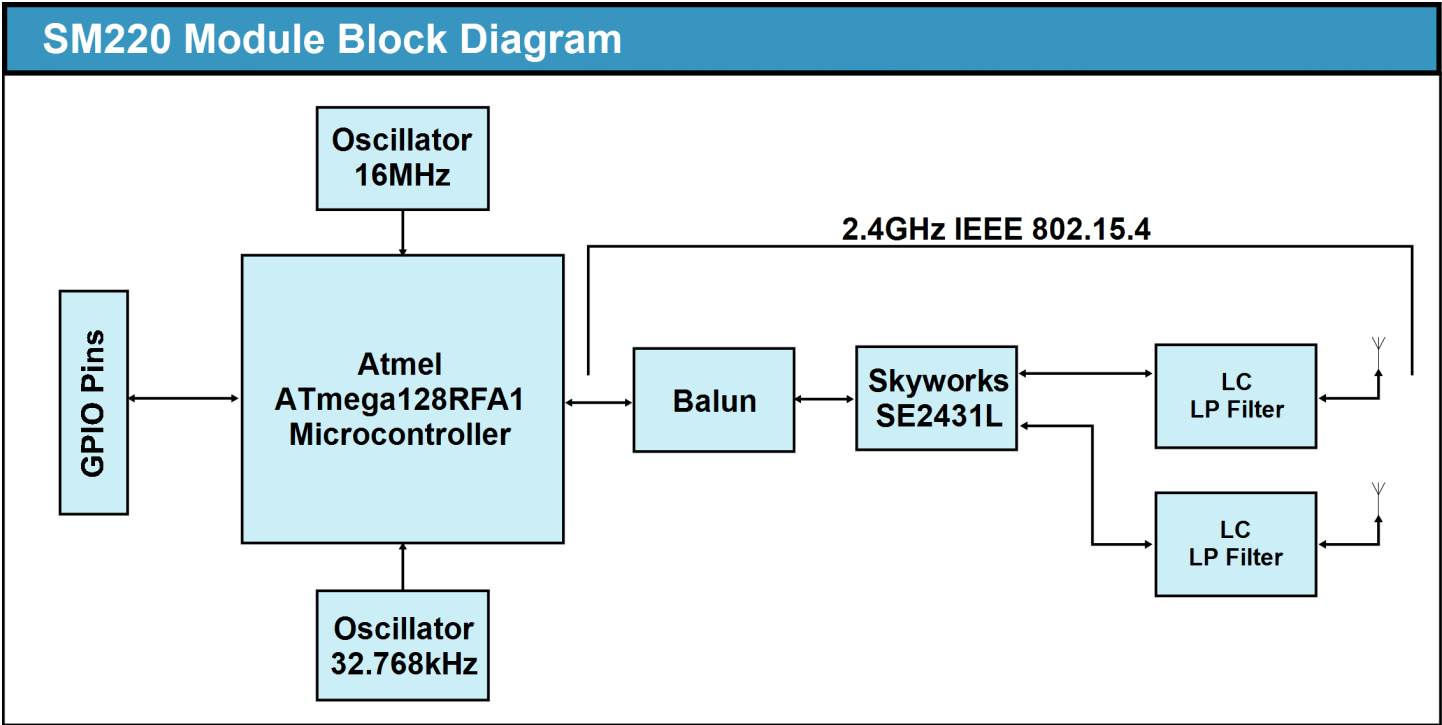

Figure 1.2: Block diagram showing the major subsystems comprising Model SM220

Selecting an Antenna

The SM220 uses the on-board compact F antenna by default. If you wish to use an external U.FL antenna with your application, you will need to set bit 0x0010 of NV ID 64 to 1. This is a one-time change that will persist through reboots and program changes. To revert to the on-board antenna, change bit 0x0010 of NV ID 64 back to 0.

Antenna Gain Performance

NOTE: Antenna gain performance information is based on information from the individual companies at the time this document's release. For added assurance, it's best to obtain antenna performance information directly from that antenna's manufacturer.

HyperLink Technologies HG2405RD-RSP

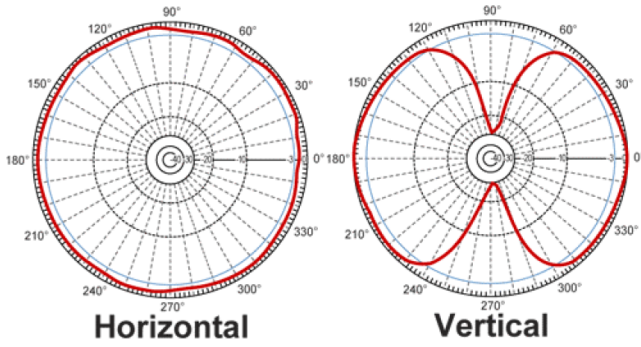
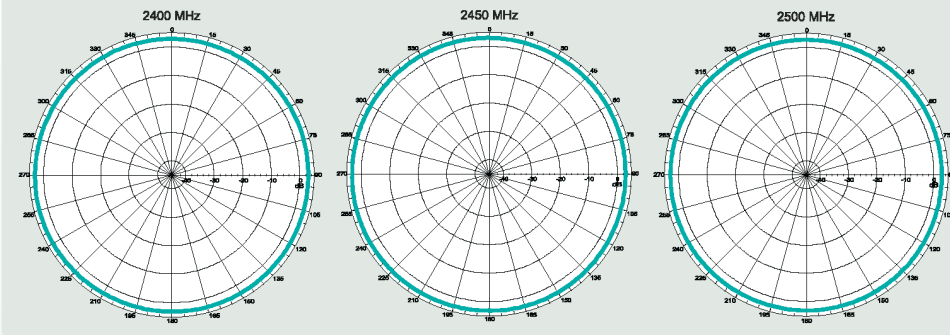

Figure 1.3: HyperLink Technologies HG2405RD-RSP Antenna Gain Performance

Pulse W1027

Horizontal Position



Vertical Position

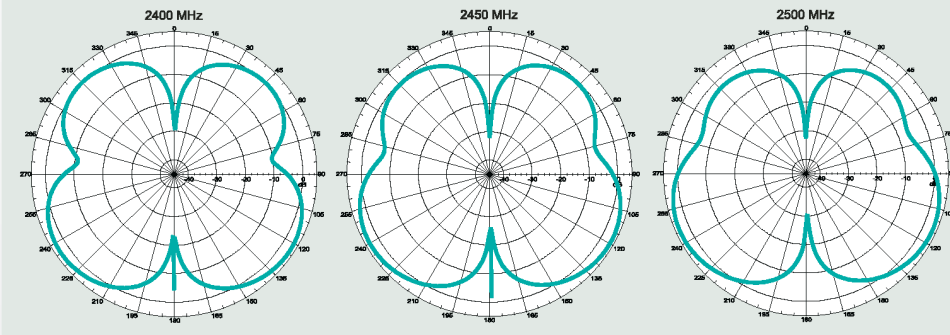

Figure 1.4: Pulse W1027 Antenna Gain Performance

ANT-2.4-CW-RAH-RPS

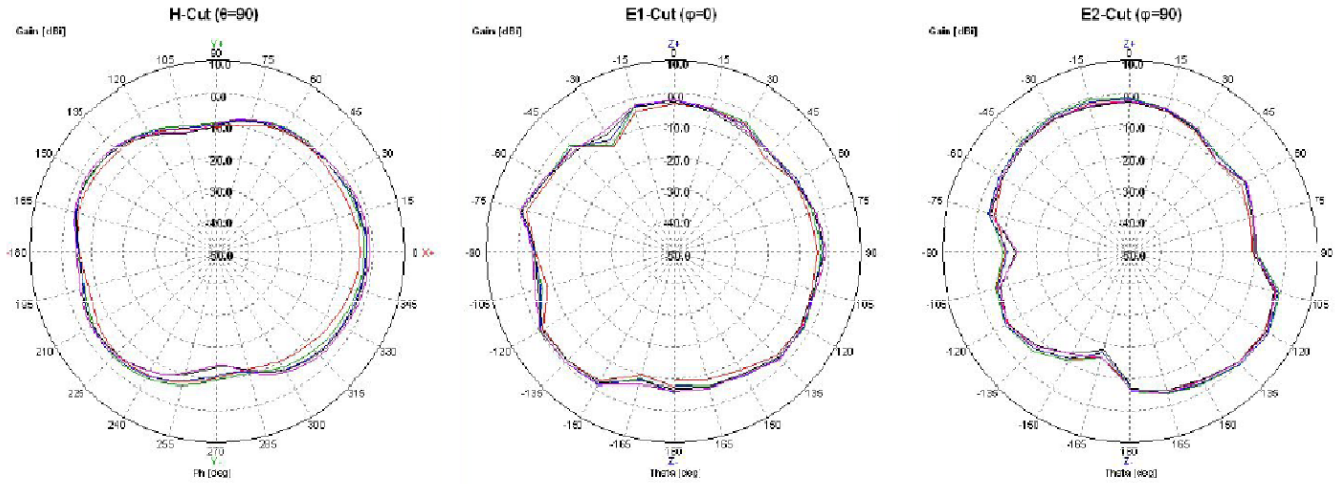

Figure 1.5: ANT-2.4-CW-RAH-RPS Antenna Gains Performance

ANT-OSC-8.0-1

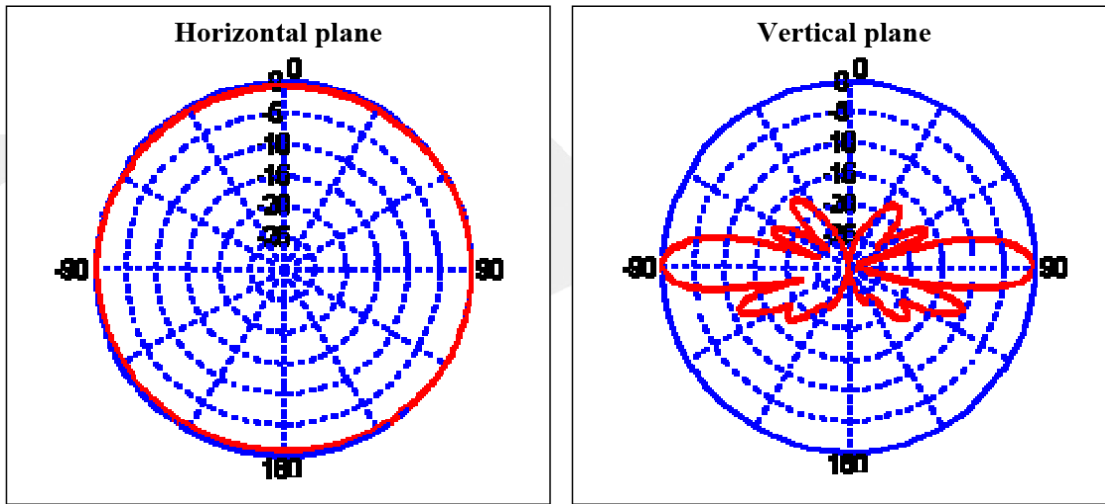

Figure 1.6: ANT-OSC-8.0-1 Antenna Gains Performance

Board Mounting Considerations

Processing

Table 1.6: Recommended Reflow Profile

Parameter	Value
Ramp up rate (from Tsoakmax to Tpeak)	3°/sec max
Minimum Soak Temperature	150°C
Maximum Soak Temperature	200°C
Soak Time	60-120 sec
TLiquidus	217°C
Time above TL	30-60 sec (recommended: 40 sec)
Tpeak	230° - 250°C (recommended: 235°C)
Time within 5° of Tpeak	20-30 sec
Time from 25° to Tpeak	8 min max
Ramp down rate	6°C/sec max

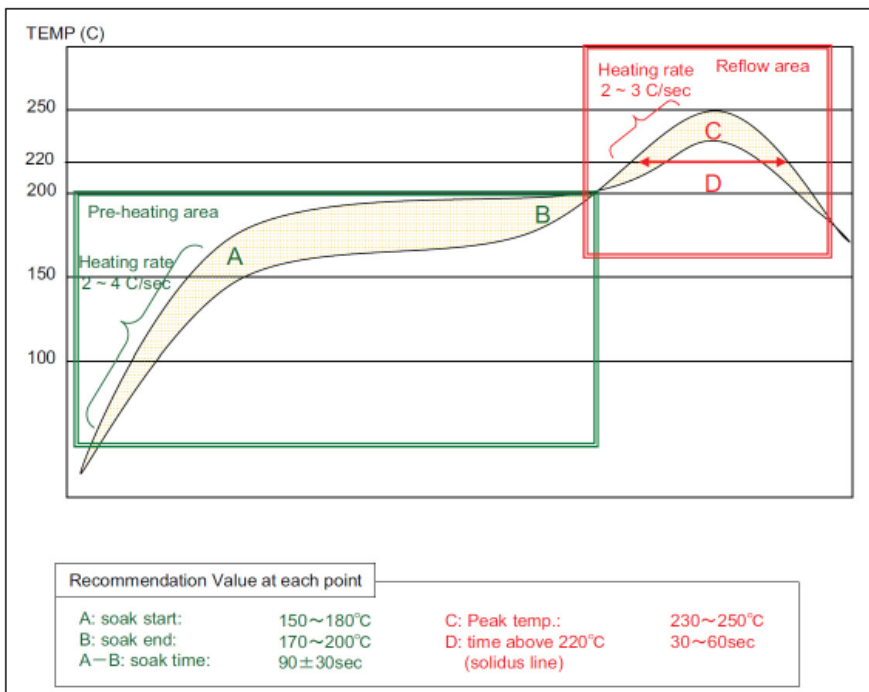

Figure 1.7: Reflow Profile Graph

Pb-Free Soldering Paste

Use of “No Clean” soldering paste is strongly recommended, as it does not require cleaning after the soldering process.

Cleaning

In general, cleaning the populated modules is strongly discouraged. Residuals under the module cannot be easily removed with any cleaning process.

- Cleaning with water can lead to capillary effects where water is absorbed into the gap between the host board and the module. The combination of soldering flux residuals and encapsulated water could lead to short circuits between neighboring pads. Water could also damage any stickers or labels.
- Cleaning with alcohol or a similar organic solvent will likely flood soldering flux residuals into the two housings, which is not accessible for post-washing inspection. The solvent could also damage any stickers or labels.
- Ultrasonic cleaning could damage the module permanently.

The recommended approach is to consider using a “no clean” soldering paste and eliminate the post-soldering cleaning step.

Repeating Reflow Soldering

Only a single reflow soldering process is encouraged for host boards.

Rework

The Model SM220 Module can be unsoldered from the host board, but the process is likely to damage the chip and not recommended. If attempting this, use of a hot air rework tool and hot plate for pre-heating from underneath is recommended. Avoid overheating.

WARNING: Never attempt a rework on the module itself (e.g. replacing individual components). Such actions will terminate warranty coverage.

Additional Grounding

Attempts to improve module or system grounding by soldering braids, wires, or cables onto the module RF shield cover is done at the customer's own risk. The numerous ground pins at the module perimeter should be sufficient for optimum immunity to external RF interference.

Packaging

Synapse SM series modules are available on plastic reels of carrier tape. The dimensions for those reels are provided below.

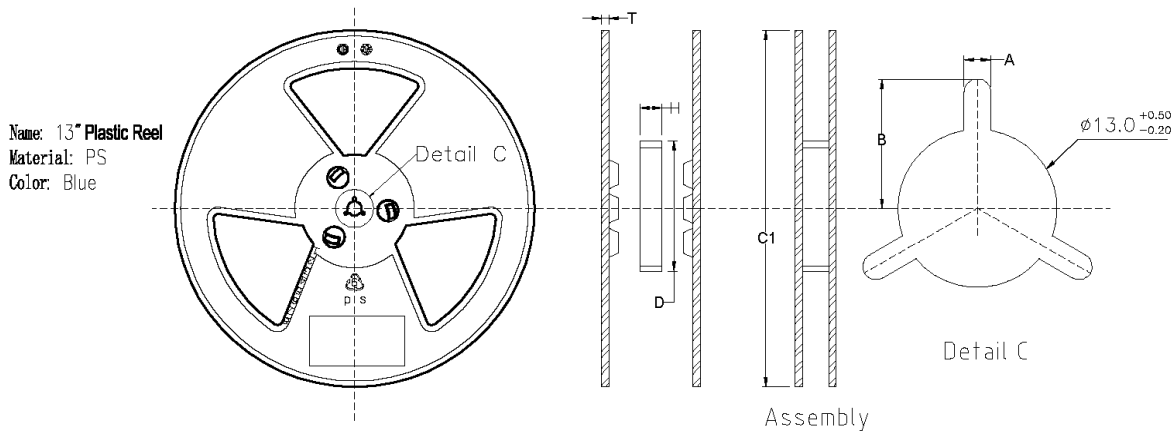

H+/-0.5	C1+/-1.0	A+/-0.2	C+0.5 -0.2	T+/-0.3	B+/-0.2	D+/-2.0
44.5	ø330	2.20	13.0	2.20	10.75	99.5

All dimensions are in mm.

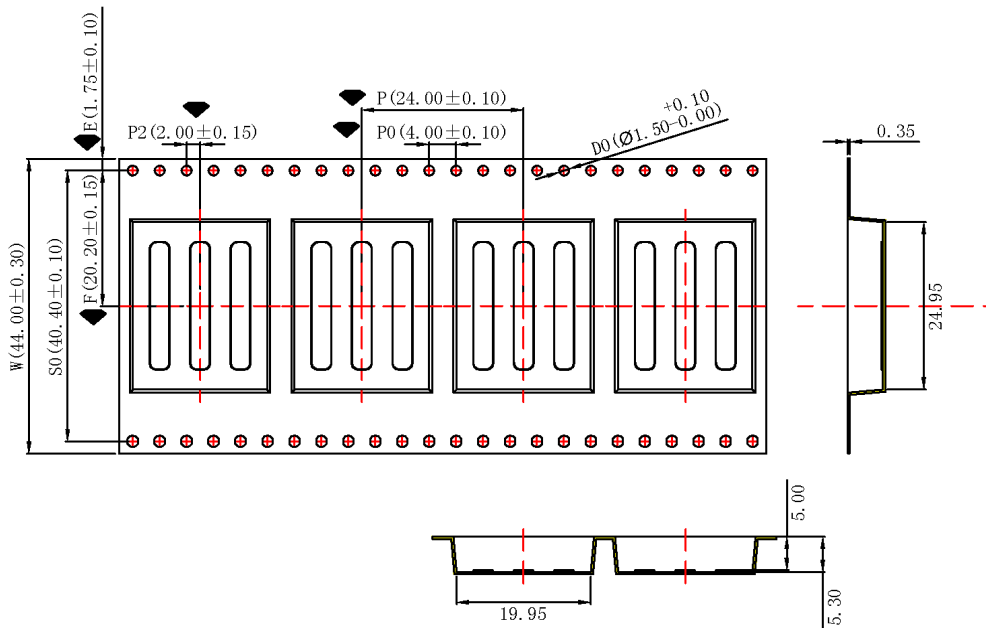

1. Sprocket hole pitch cumulative tolerance: +/-0.2mm.
2. Carrier camber not to exceed 1mm in 250mm.
3. All dimensions meet EIA-481-C requirements.
4. Thickness: 0.35mm +/- 0.05mm.
5. Packing length per reel: 12.6 meters.
6. Component load per reel: 500 pieces.

Agency Certifications

United States (FCC)

The Model SM220 modules comply with Part 15 of the FCC rules and regulations. Compliance with the labeling requirements, FCC notices, and antenna usage guidelines is required. In order to comply with FCC Certification requirements, the Original Equipment Manufacturer (OEM) must fulfill the following requirements.

1. The system integrator must place an exterior label on the outside of the final product housing the SM220 Modules. **FCC Label on page 16** below shows the contents that must be included on this label.
2. SM220 Modules may only be used with the antenna that has been tested and approved for use with the module. Please refer to the antenna table provided in this section.

OEM Labeling Requirements

NOTICE: The OEM must make sure that FCC labeling requirements are met. This includes a clearly visible exterior label on the outside of the final product housing that displays the contents shown in **FCC Label on page 16** below.

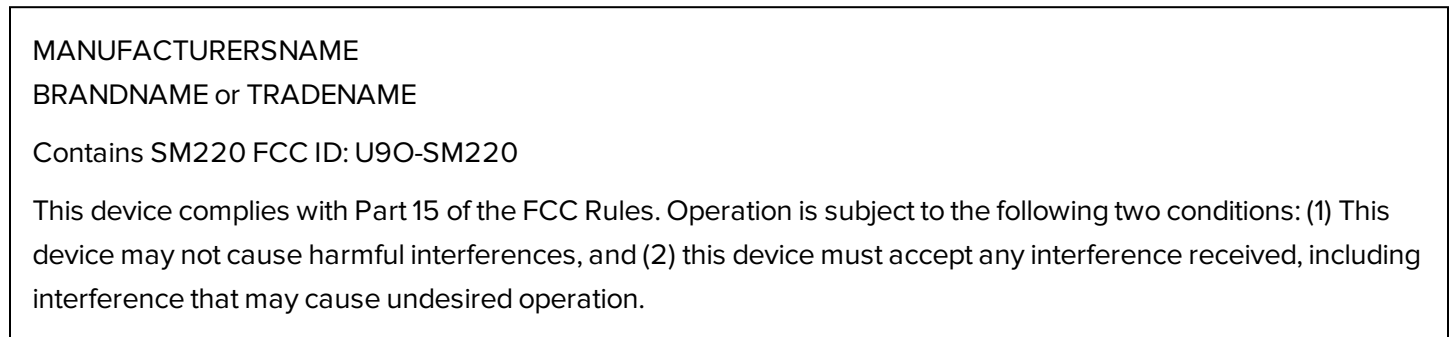

Figure 1.8: FCC Label

FCC Notices

WARNING: The SM220 modules have been tested by the FCC for use with other products without further certification (as per FCC Section 2.1091). Changes or modifications to this device not expressly approved by Synapse Wireless Inc. could void the user's authority to operate the equipment.

NOTICE: OEM's must certify final end product to comply with unintentional radiators (FCC Sections 15.107 and 15.109) before declaring compliance of their final product to Part 15 of the FCC Rules.

NOTICE: The SM220 modules have been certified for remote and base radio applications. If the module will be used for portable applications as defined by the FCC, the device must undergo SAR testing.

NOTE: This equipment has been tested and found to comply with the limits for a Class B digital device, pursuant to Part 15 of the FCC Rules. These limits are designed to provide reasonable protection against harmful interference in a residential installation. This equipment generates, uses, and can radiate radio frequency energy and, if not installed

and used in accordance with the instructions, may cause harmful interference to radio communications. However, there is no guarantee that interference will not occur in a particular installation. If this equipment does cause harmful interference to radio or television reception, which can be determined by turning the equipment off and on, the user is encouraged to try to correct the interference by one or more of the following measures:

- Reorient or relocate the receiving antenna.
- Increase the separation between the equipment and receiver.
- Connect the equipment into an outlet on a circuit different from that to which the receiver is connected.
- Consult the dealer or an experienced radio/TV technician for help.

This device complies with Industry Canada licence-exempt RSS standard(s). Operation is subject to the following two conditions: (1) this device may not cause interference, and (2) this device must accept any interference, including interference that may cause undesired operation of the device.

Le présent appareil est conforme aux CNR d'Industrie Canada applicables aux appareils radio exempts de licence. L'exploitation est autorisée aux deux conditions suivantes : (1) l'appareil ne doit pas produire de brouillage, et (2) l'utilisateur de l'appareil doit accepter tout brouillage radioélectrique subi, même si le brouillage est susceptible d'en compromettre le fonctionnement.

FCC Approved Antennas

The SM220 modules are FCC-approved for fixed base station and mobile applications.

Notice: To reduce potential radio interference to other users, the antenna type and its gain should be chosen so that the equivalent isotropically radiated power (EIRP) is not more than that permitted for successful communication. This module has been designed to operate with the antennas listed in **SM220 Approved FCC Antenna on page 17** and **SM220 Approved FCC Antennas on page 17** below. The required antenna impedance is 50 ohms.

Table 1.7: SM220 Approved FCC Antenna

Part Number	Type	Gain	Impedance	Application	Min. Separation
Compact F Antenna	PC Board Trace Antenna	0.0 dBi	50Ω	Fixed/Mobile	20 cm.

Table 1.8: SM220 Approved FCC Antennas

Part Number	Type	Gain	Impedance	Application	Min. Separation
Pulse W1027	Dipole (quarter-wave RPSMA)	3.2 dBi	50Ω	Fixed/Mobile	20 cm.
HyperLink HG2405RD-RSP	Dipole (quarter-wave RPSMA)	5.5 dBi	50Ω	Fixed/Mobile	20 cm.
ANT-OSC-8.0-1	Whip (RPSMA)	8 dBi	50Ω	Fixed/Mobile	20 cm.

Part Number	Type	Gain	Impedance	Application	Min. Separation
ANT-2.4-CW-RAH-RPS	Helical Whip (quarter-wave RPSMA)	1.6 dBi	50Ω	Fixed/Mobile	20 cm.
ANT-2.4-CW-RH-RPS	Helical Whip (quarter-wave RPSMA)	-0.9 dBi	50Ω	Fixed/Mobile	20 cm.

For more information on approved antennas, please consult the manufacturer's website.

WARNING: RF Exposure: This equipment complies with FCC radiation exposure limits set forth for an uncontrolled environment. This equipment should be installed and operated with minimum distance 20 cm between the radiator and your body. This transmitter must not be co-located or operating in conjunction with any other antenna or transmitter.

NOTICE: The preceding statement must be included as a CAUTION statement in OEM product manuals in order to alert users of FCC RF exposure compliance.

NOTE: Antenna and transmitters may be co-located or operated in conjunction with this device only if the transmitters do not simultaneously transmit. Otherwise, additional regulatory requirements will apply.

Canada (IC)

This device complies with Industry Canada license-exempt RSS standard(s). Operation is subject to the following two conditions: (1) this device may not cause interference, and (2) this device must accept any interference, including interference that may cause undesired operation of the device.

Le présent appareil est conforme aux CNR d'Industrie Canada applicables aux appareils radio exempts de licence. L'exploitation est autorisée aux deux conditions suivantes : (1) l'appareil ne doit pas produire de brouillage, et (2) l'utilisateur de l'appareil doit accepter tout brouillage radioélectrique subi, même si le brouillage est susceptible d'en compromettre le fonctionnement.

Under Industry Canada regulations, this radio transmitter may only operate using an antenna of a type and maximum (or lesser) gain approved for the transmitter by Industry Canada. To reduce potential radio interference to other users, the antenna type and its gain should be so chosen that the equivalent isotropically radiated power (EIRP) is not more than that necessary for successful communication.

Conformément à la réglementation d'Industrie Canada, le présent émetteur radio peut fonctionner avec une antenne d'un type et d'un gain maximal (ou inférieur) approuvé pour l'émetteur par Industrie Canada. Dans le but de réduire les risques de brouillage radioélectrique à l'intention des autres utilisateurs, il faut choisir le type d'antenne et son gain de sorte que la puissance isotrope rayonnée équivalente (p.i.r.e.) ne dépasse pas l'intensité nécessaire à l'établissement d'une communication satisfaisante.

This radio transmitter Model: SM220, IC: 7084A-SM220 has been approved by Industry Canada to operate with the antenna types listed below with the maximum permissible gain and required antenna impedance for each antenna type indicated. Antenna types not included in this list, having a gain greater than the maximum gain indicated for that type, are strictly prohibited for use with this device.

Le présent émetteur radio Model : SM220, IC : 7084A-SM220 a été approuvé par Industrie Canada pour fonctionner avec les types d'antenne énumérés ci-dessous et ayant un gain admissible maximal et l'impédance requise pour chaque type d'antenne. Les types d'antenne non inclus dans cette liste, ou dont le gain est supérieur au gain maximal indiqué, sont strictement interdits pour l'exploitation de l'émetteur.

Table 1.9: SM220 Approved IC Antenna

Part Number	Type	Gain	Application	Min. Separation
Compact F Antenna	PC Board Trace Antenna	0.0 dBi	Fixed/Mobile	20 cm.

Table 1.10: SM220 Approved IC Antennas

Part Number	Type	Gain	Application	Min. Separation
Pulse W1027	Dipole (quarter-wave RPSMA)	3.2 dBi	Fixed/Mobile	20 cm.
HyperLink HG2405RD-RSP	Dipole (quarter-wave RPSMA)	5.5 dBi	Fixed/Mobile	20 cm.
ANT-OSC-8.0-1	Whip (RPSMA)	8 dBi	Fixed/Mobile	20 cm.
ANT-2.4-CW-RAH-RPS	Helical Whip (quarter-wave RPSMA)	1.6 dBi	Fixed/Mobile	20 cm.
ANT-2.4-CW-RH-RPS	Helical Whip (quarter-wave RPSMA)	-0.9 dBi	Fixed/Mobile	20 cm.

IC OEM Labeling Requirements

Labeling requirements for Industry Canada are similar to those of the FCC. A clearly visible label on the outside of the final product housing must display the contents shown in **IC Label on page 19** below.

MANUFACTURERSNAME BRANDNAME or TRADENAME MODEL: Contains SM220 IC: 7084A-SM220

Figure 1.9: IC Label

NOTE: The OEM can choose to implement a single label combined for both FCC and IC labeling requirements. If a combined single label is chosen, there must be a clearly visible label on the outside of the final product housing displaying the contents shown in **Combined FCC and IC Label** on page 20 below.

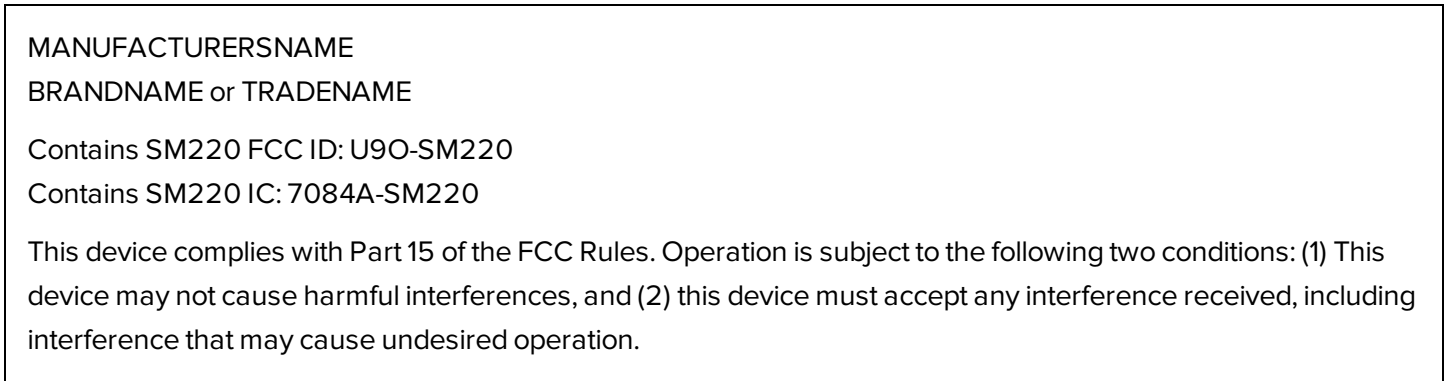

Figure 1.10: Combined FCC and IC Label

ESD Warnings

NOTE: The SM220UF1 modules are ESD sensitive devices.

During your manufacturing or assembly process, it is critical to have good ESD controls in place when handling the device or connecting an external antenna to the u.FL connector.

During field installation process, Synapse recommends the following practices when connecting an antenna or cable to the RP-SMA bulkhead:

NEEDED MATERIALS

· 50 OHM Terminator plug RP-SMA: Part Number 132360RP from Amphenol

ATTACHING THE TERMINATOR TO THE BULKHEAD

Make sure the power is off. Attach the 50 OHM Terminator to the RP-SMA bulkhead hand tight. Keep the 50 OHM Terminator on the bulkhead at all times, until the antenna replaces the 50 OHM Terminator. When installing the device, the technician must be grounded with a proper ground strap.

ATTACHING THE ANTENNA

When it is time to attach the antenna, touch a grounded surface, remove the 50 OHM Terminator and screw on the antenna tightly. Tighten a 1/4 turn with a pair of needle nose pliers. Do not overtighten or the RF pin in the bulkhead will crack, creating poor RF link quality.