

Manual actuated valves

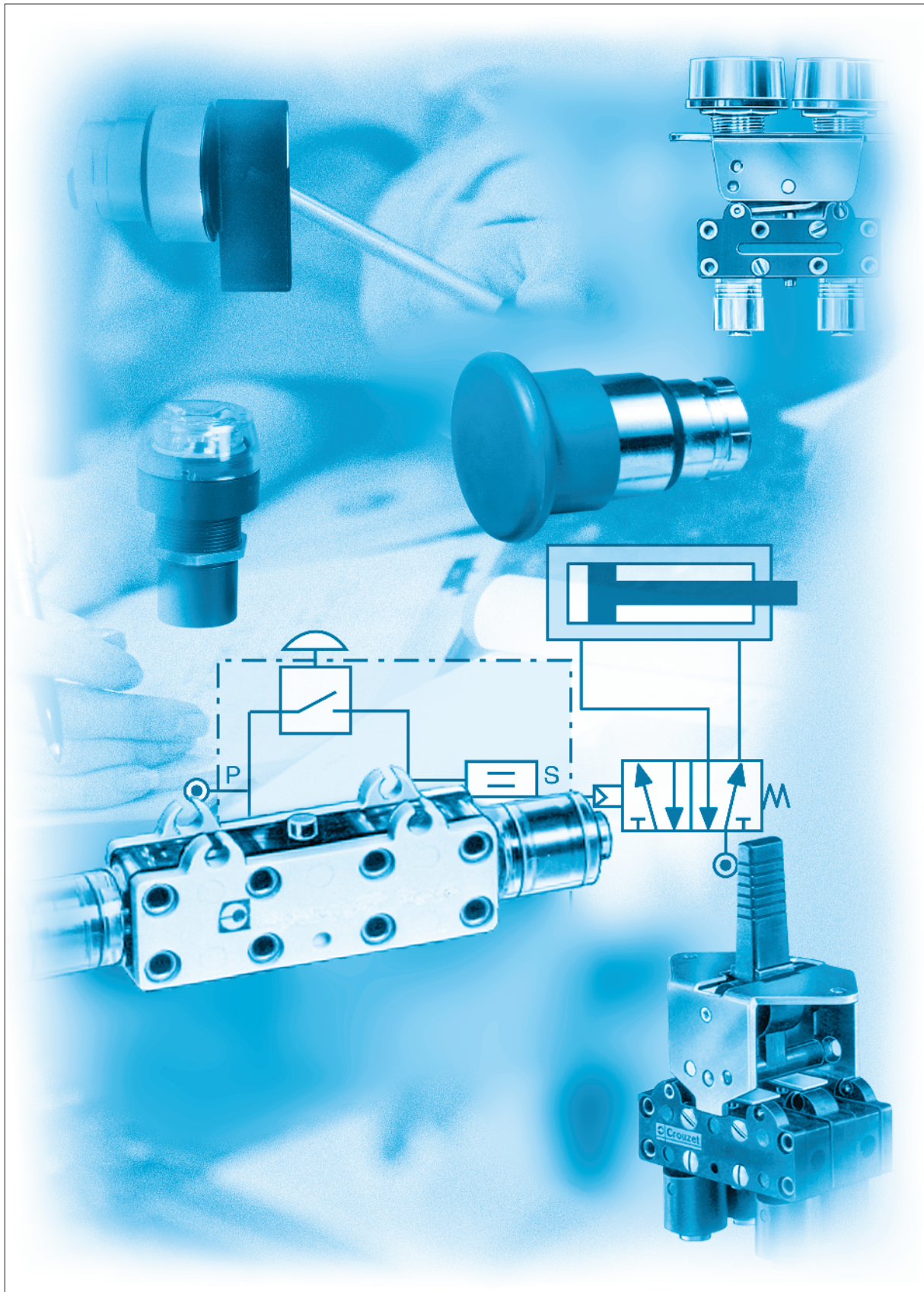

Push buttons diameter 12 and actuators

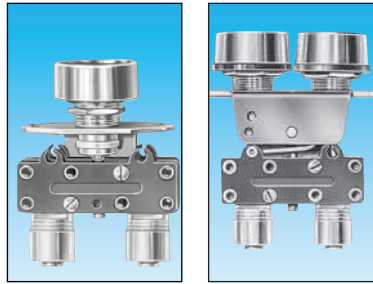

Features	Actuator color	Valve color	Push button round	Push button double round
Version	NC	black	81 735 511	—
		red	81 735 512	—
		black/red	—	81 733 511
Version	NO	black	81 735 011	—
		red	—	—
		black/red	—	—

Symbol

NC

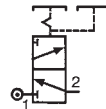
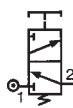

NO

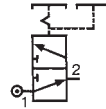
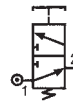

Characteristics

Operating pressure	bar	2 → 8	2 → 8
Orifice diameter	mm	2.7	2.7
Flow at 6 bars	NI/mn.	200	200
Valves	NC : black NO : grey	• •	• •
Operating forces (depending on actuator)	N	8 → 18	8 → 18
Effective travel	mm	1	1
Fluid: dry or lubricated air		•	•
Push-in connectors for semi-rigid tubing (NFE 49100)	mm	Ø 4	Ø 4
Operating temperature	°C	-5 → +50	-5 → +50
Mechanical life	operations	1.5 x 10 ⁶	1.5 x 10 ⁶
Weight	g	35	40

Dimensions

81 735

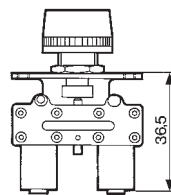

81 733

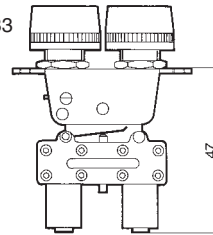

Threaded barrel

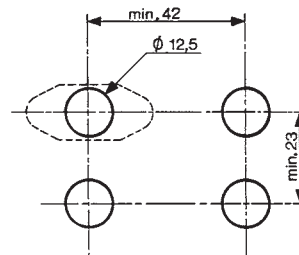

2 threaded barrels

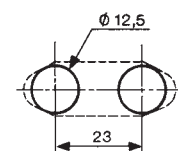

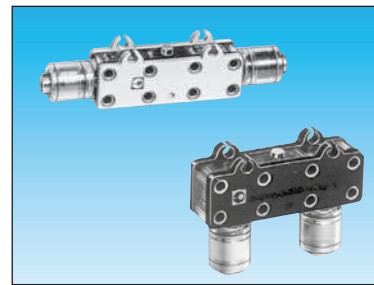
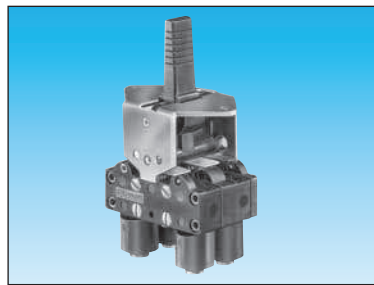
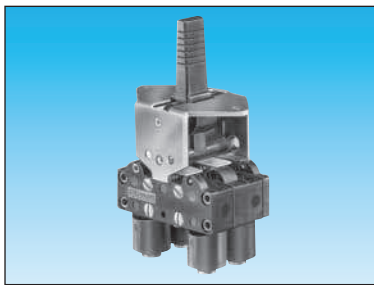

3-position lever
manual return

81 716 511
81 716 512

—
—
—
—

3-position lever
spring return

81 715 511
81 715 512

—
—
—
—

Horizontal outputs

81 280 510

—
81 280 010
—
—

Vertical outputs

81 281 510

—
81 281 010
—
—

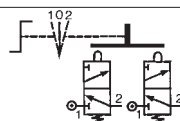
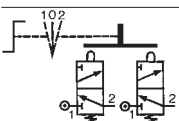

2 → 8
2.7
200

8 → 18
1

Ø 4

-5 → +50
1.5 x 10⁶
65

2 → 8
2.7
200

8 → 18
1

Ø 4

-5 → +50
1.5 x 10⁶
65

2 → 8
2.7
200

8 → 18
1

Ø 4

-5 → +50
1.5 x 10⁶
14

2 → 8
2.7
200

8 → 18
1

Ø 4

-5 → +50
1.5 x 10⁶
14

81 715 - 81 716

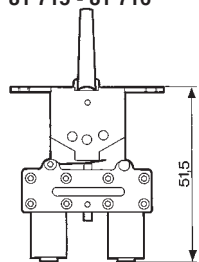

Square lever

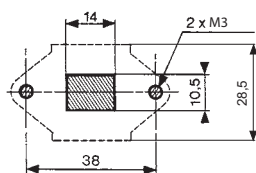

81 280 010 - 81 280 510

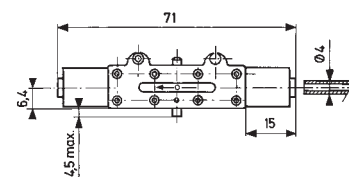

81 281 010 - 81 281 510

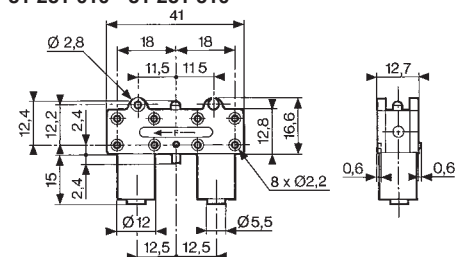

3/2 valves for manual actuators Ø 22 mm



3/2 valve supplied with screws for fixing the adaptor	Connection Ø4	89 543 501	89 543 101	—	—	—	—	—
	Gas 1/8	89 543 701	89 543 201	—	—	—	—	—
Valve(s) 3/2 fixed on adaptor (supplied with adaptor not assembled)	Connection Ø4	—	—	89 543 105	89 543 005	89 543 305	89 543 205	—
Adaptor for 3/2 valve on actuators Ø 22		—	—	—	—	—	—	24 679 702
Version		NC	NO	NC	NO	NC + NO	NC + NC	

Symbol

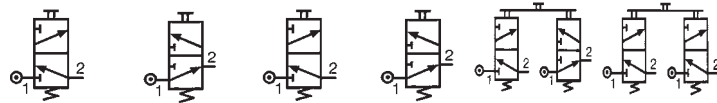

Characteristics

Operating pressure	bar	0 → 8	0 → 8	0 → 8	0 → 8	0 → 8	0 → 8	—
Orifice diameter	mm	2	2	2	2	2	2	—
Flow at 6 bars	NI/min	112	112	112	112	112	112	—
Control force	N	12.6	12.6	12.6	12.6	12.6	12.6	—
Operating temperature in dry air	°C	-5 → +60	-5 → +60	-5 → +60	-5 → +60	-5 → +60	-5 → +60	—
Life	operations	1.5 x 10 ⁶	1.5 x 10 ⁶	1.5 x 10 ⁶	1.5 x 10 ⁶	1.5 x 10 ⁶	1.5 x 10 ⁶	—
Non-connectable exhaust		●	●	●	●	●	●	—
Weight	g	50	50	60	60	110	110	40

Principle of operation

NC version

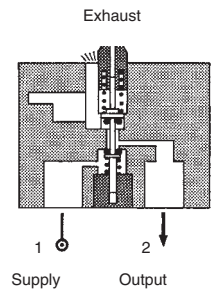

Dimensions

89 543 001 - 89 543 201
89 543 501 - 89 543 701

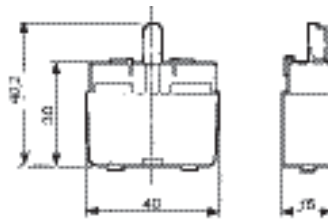

Ø 22 series

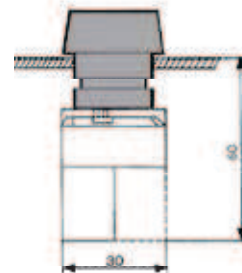

Holes drilled in panel for actuators Ø 22

EN 50007

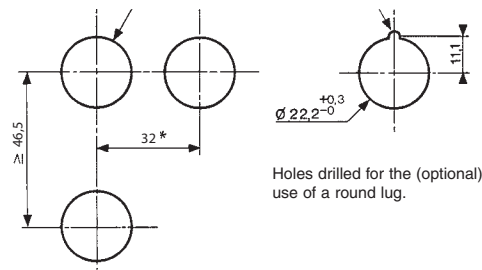



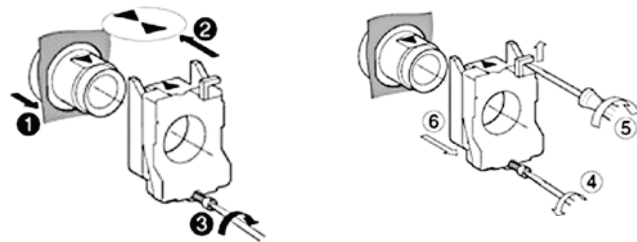

Holes drilled for the (optional) use of a round lug.

* > 40 Ø 40 push-buttons
* > 45 for lever type rotary switches

Installation



Actuators Ø 22 mm for manually operated valves

						
Push buttons	Red Green Black	24 678 129 24 678 128 24 678 127	24 678 173 — 24 678 172	24 678 171 — —	— — —	— — —
2-positions rotary switches		—	—	—	24 678 174	24 678 175
3-positions rotary switches		—	—	—	—	—
Function		Flush push contact	Emergency stop plastic Ø 40	Emergency stop Ø 40 mm push-turn	Black symmetrical actuator	Long lever Black

Symbol



Position

						
Weight	g	30	45	45	45	45

Dimensions







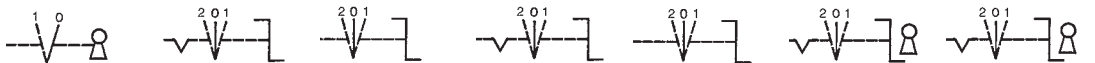

2-positions rotary switches	24 678 180	—	24 678 176	24 678 178	24 678 177	24 678 179	24 678 182	24 678 181
3-positions rotary switches	—	—	—	—	—	—	—	—
Function	RONIS key 455 removable in position 0	Black symmetrical actuator	Black symmetrical actuator with return	Long lever Black	Black Long lever, spring to center	RONIS key 455 remov. in pos. 0 3 positions with spring to center	RONIS key 455 removable in position 0 3 fixed positions	

Symbol



Position

							
Weight	70	45	45	16	45	70	70

Dimensions

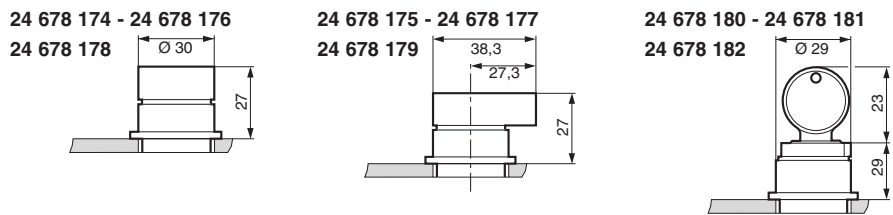

Pneumatic 2-hand control

Conforms to the Machinery Directive



Definition (conforming to EN 574 +A1)

A pneumatic 2-hand control device is used with dangerous machinery and requires the simultaneous use of both hands to trigger and maintain machine operation. Such a device must be located outside the dangerous zone, so that the operator cannot enter this zone before the machine has come to a complete standstill.

A pneumatic 2-hand control device is composed of 2 parts :

- 2 manual pushbuttons which require the simultaneous use of both hands.
- A pneumatic relay.

Types of 2-hand control devices

Requirements	Type				
	I	II	III		
			A	B	C
Use of both hands (simultaneous actuation)	●	●	●	●	●
Relationship between input signals and output signal	●	●	●	●	●
Cessation of the output signal	●	●	●	●	●
Prevention of accidental operation	●	●	●	●	●
Prevention of defeat	●	●	●	●	●
Reinitiation of the output signal		●	●	●	●
Synchronous actuation			●	●	●
Use of category 1 (EN 954-1)	●		●		
Use of category 3 (EN 954-1)		●		●	
Use of category 4 (EN 954-1)					●

Category 1 (EN ISO 13849) : the system should use well tried components and principles.

Category 3 (EN ISO 13849) : the system must be designed so that a single fault will not cause the loss of the safety function.

Category 4 (EN ISO 13849): the system must be designed so that an accumulation of faults must not lead to a loss of the safety function.

Synchronous action

An output signal is only generated if both control actuating devices are actuated within 500 ms.

Resetting the output signal

The release of a single control device interrupts the output signal, but a reset is only possible once both control devices have been released.

Pneumatic relay for two-hand control

- 100% pneumatic
- Complies with Machinery Directive and the standard EN 574 +A1
- CE Certification type-IIIA and IIIB

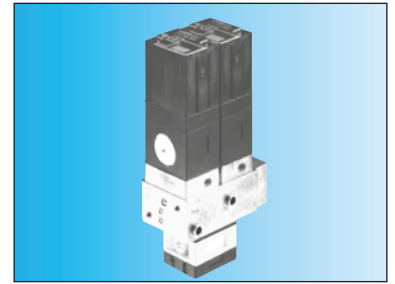
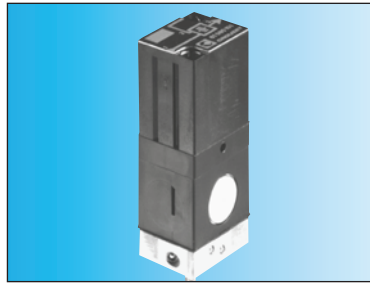

Pneumatic relay for two-hand control
EN 574 +A1 classification

81 580 101
III A

81 580 202
III B

Symbol

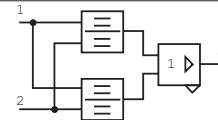

Characteristics

Operating pressure	bar	2 → 8	2 → 8
Orifice diameter	mm	2.5	2.5
Max. delay between input signals	s	0.2 max.	0.2 max.
Connection		Sub-base 81 532 001	Semi-rigid tubing Ø 4 (NFE 49100)
Operating temperature	°C	-5 → +50	-5 → +50
Mechanical life	operations	10 ⁷	10 ⁷
Weight	g	90	320

Principle of operation

81 580 101

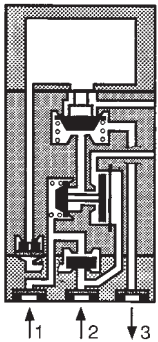

To obtain an output signal it is necessary to give simultaneous input signals 'a' and 'b' with a max. delay of 0.45. The output signal 's' is lost if one or both of the inputs are removed.

Connections (Typical application with double-acting cylinder)

81 580 101

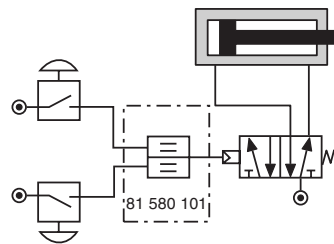

Components follow current standards

81 580 202

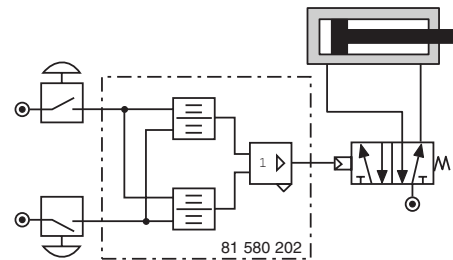

Dimensions

81 580 101

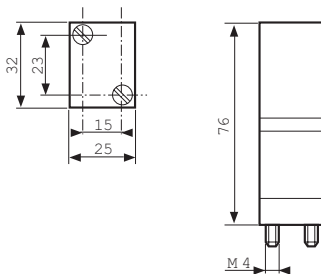

Mounted on sub-base 81 532 001
(See page 55 of Pneumatic catalogue)

81 580 202

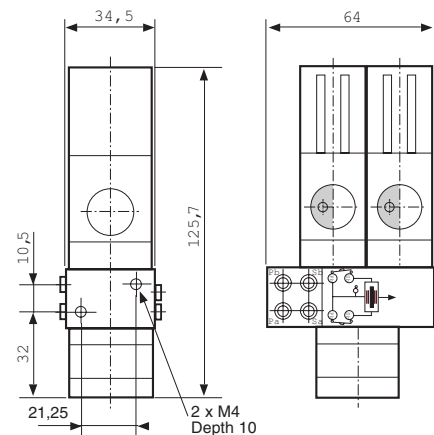

Two-hand pneumatic safety start module

- Conforms to the Machinery Directive and standard EN 574
- Including pneumatic relay to classification IIIA or IIIB depending on version

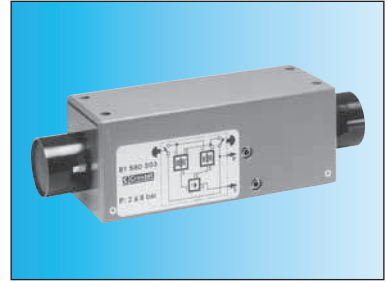
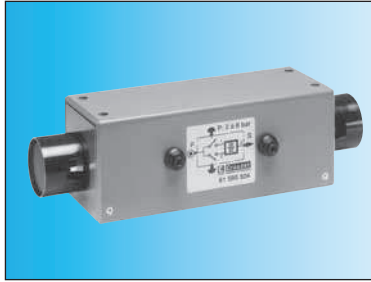

Two-hand pneumatic safety start module
Pneumatic relay (to EN 574)

81 580 504
Type III A

81 580 503
Type III B

Symbol

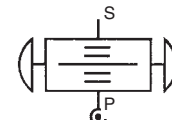
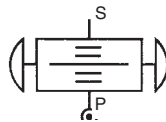

Characteristics

Operating pressure	bar	2 → 8	2 → 8
Orifice diameter	mm	2.5	2.5
Max. delay between input signals	s	0.2 max.	0.2 max.
Connection		Semi-rigid tubing Ø 4 (NFE 49100)	Semi-rigid tubing Ø 4 (NFE 49100)
Operating temperature	°C	-5 → +50	-5 → +50
Mechanical life	operations	1.5 x 10 ⁶	1.5 x 10 ⁶
Weight	g	1000	1410

Connections (Typical application with double-acting cylinder)
81 580 504

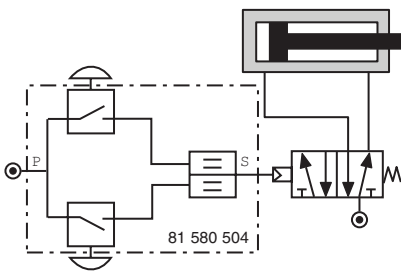

81 580 503

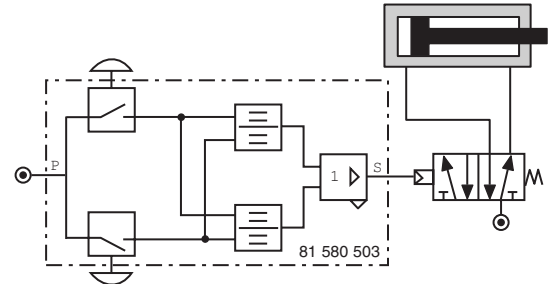

Components follow current standards

Dimensions

81 580 503 - 81 580 504

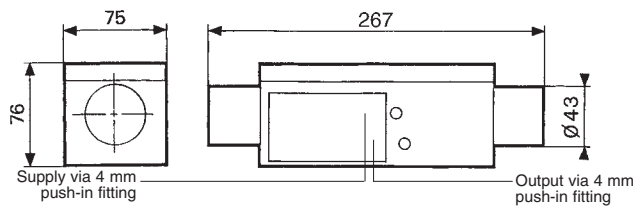

Fixing viewed from below

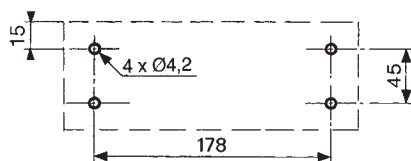

Pneumatic impulse counters

- 4, 5, 6 digits with or without reset
- With or without pre-selection

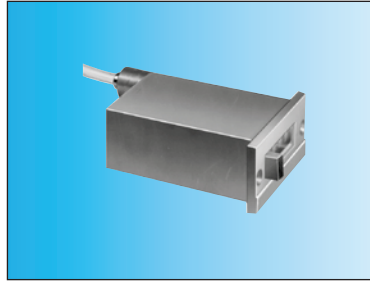

Totalizer	99 766 001	99 766 002	89 538 201
Preselection counter	—	—	—
Version	6 digits no reset to zero	4 digits with manual zero reset	5 digits with manual or pneumatic zero reset

Symbol



Characteristics

Supply pressure	bar	2 → 8	2 → 8	2 → 8
Pressure to break	bar	> 0.3	> 0.3	> 0.15
Pressure to make	bar	> 1.4	> 1.4	> 0.8
Reset :				
Minimum pressure	bar	—	—	2
Reset time	ms	—	—	150
Circuit pressure	bar	—	—	2 → 8
bar		—	—	•
Signal emitted when preset is reached		0 → +60	0 → +60	0 → +60
Operating temperature	°C	150	150	136
Weight	g			

Connection

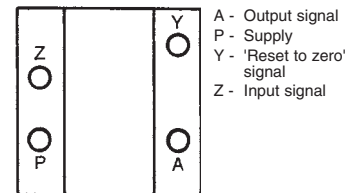

Note : the count pulse must be removed before the reset pulse is applied. The pre-set value can be changed during operation without the counter resetting to zero.

Dimensions

Connectors for semi-rigid tubing Ø 4 (NFE 49100)

99 766 002

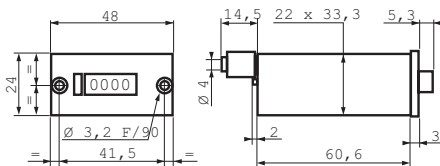

99 766 001

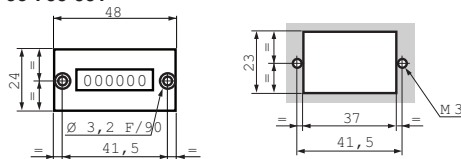

89 538 201

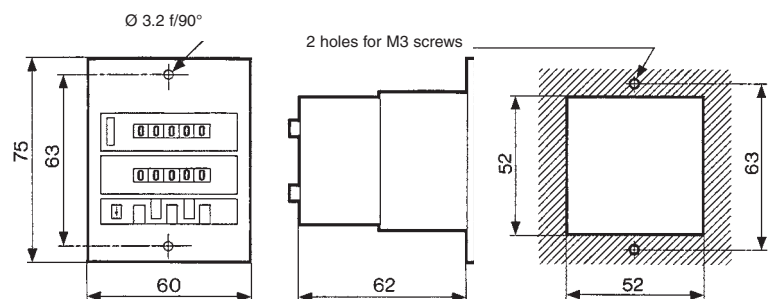

Indicators and pedal valves

Ergonomics



Also available in **ATEX** version for use in potentially explosive atmospheres in accordance with 94/9/EC Directive

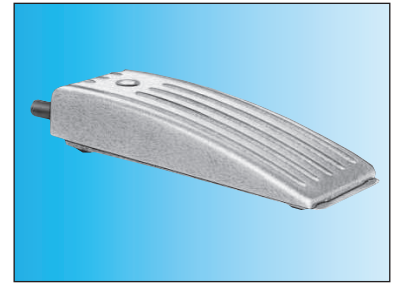

Pneumatic indicators Ø 22	Red	84 150 201	—
	Green	84 150 202	—
	Yellow	84 150 203	—
	Blue	84 150 204	—
Pedal valve - Version NC		—	81 999 501

Symbol

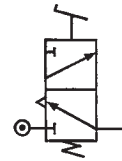

Characteristics

Operating pressure	bar	2 → 8	—
Push-in connection for semi-rigid tubing (NFE 49100)	mm	Ø4	Ø4
Operating temperature	°C	-5 → +50	-5 → +50
Mechanical life	operations	10 ⁷	1.5 x 10 ⁶
Weight	g	34	290

Dimensions

84 150 201 - 84 150 202
84 150 203 - 84 150 204

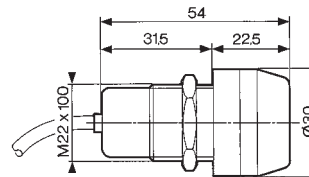

81 999 501

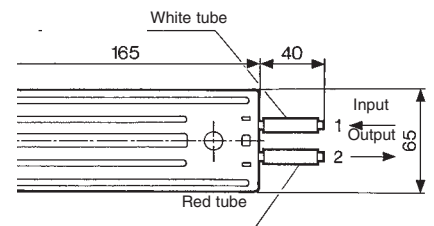

Holes drilled for indicators

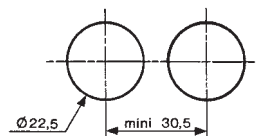

ATEX version products are available in the following catalogues: **Pneumatic products for explosive atmospheres** or on our website www.crouzet.com

Mouser Electronics

Authorized Distributor

Click to View Pricing, Inventory, Delivery & Lifecycle Information:

Crouzet:

[81580101](#) [99766001](#) [84150201](#) [81735512](#) [89543105](#) [81735011](#) [99766002](#) [81580202](#) [81281010](#) [24678175](#)
[81281510](#) [81735012](#) [81735511](#) [81580503](#) [81733511](#) [81716512](#) [81715511](#) [81716511](#) [81580504](#)