



TAOGLAS®



Datasheet

4G LTE Roadmarker

Part No:
RG.02.02.3000W

Description:

Roadmarker Low Profile 4G LTE Cellular Antenna
with CAB.820 cable assembly

Features:

Low Profile
4G LTE Cellular Antenna
UV and Vandal Resistant PP Enclosure
IP67 Rated Enclosure
Diameter: 101.4mm
Height: 17.6mm
RoHS & Reach Compliant

1. Introduction	3
2. Specifications	4
3. Antenna Characteristics	7
4. Radiation Patterns	10
5. Mechanical Drawing – Roadmarker	29
6. Mechanical Drawing – Cable Assembly	30
7. Packaging	31
<hr/>	
Changelog	32

Taoglas makes no warranties based on the accuracy or completeness of the contents of this document and reserves the right to make changes to specifications and product descriptions at any time without notice. Taoglas reserves all rights to this document and the information contained herein. Reproduction, use or disclosure to third parties without express permission is strictly prohibited.



1. Introduction



The Roadmarker RG.02 has been designed to be used inside standard raised non-reflective roadmarkers. These are designed for, and installed inside, the low profile “Bott’s dots” that can to be mounted directly on the pavement and therefore the roads.

The Roadmarker uses a high efficiency 4G LTE antenna that can also operate at 3G/2G and NB-IoT/Cat-M bands, if fallback is required.

These antennas exhibit relatively high efficiencies in such small packages and reside in a very low-profile enclosure. They are designed to be mounted directly on the road and pavement just like a standard roadmarker.

Typical Applications Include:

- Smart Metering
- Remote Monitoring
- Security

These antennas have been potted with the epoxy that is traditionally used to secure the roadmarker itself to the ground. There are no air gaps whatsoever inside the new type approved roadmarker with antenna, in order to maintain the mechanical integrity. It is presumed that the standard black epoxy will also be used to install the roadmarker in its final resting place on the ground.

The cable and connector are fully customizable, for further information please contact your regional Taoglas customer support team.

2. Specifications

Electrical								
Band	Frequency (MHz)		Efficiency(%)	Average Gain(dB)	Peak Gain (dBi)	Impedance	Max Input Power	Radiation Pattern
4G/3G Band 12,13,14,17,28,29	698~806	With Cable Assembly	28	-5.7	2.1	50Ω	10W	Omnidirectional
		Without Cable Assembly	37	-4.4	3.2			
4G/3G/NB-IoT/Cat M Band 5,8,18,19,20,26,27	824~960	With Cable Assembly	33	-4.8	1.2			
		Without Cable Assembly	42	-3.8	2.4			
4G/3G Band 1,2,3,4,9,23,25,35,39,66	1710~2200	With Cable Assembly	21	-7.0	-0.9			
		Without Cable Assembly	27	-5.8	0.8			
4G/3G Band 7,30,38,40,41	2300~2690	With Cable Assembly	27	-5.7	0.0			
		Without Cable Assembly	39	-4.1	1.7			
Mechanical								
Dimensions (mm)	Height = 17.6 mm and Diameter = 101.4 mm							
Cable	WY-100 Coaxial Cable							
Connector	SMA(M)ST							
Casing	UV Resistant PP							
Sealant	Potting							

Environmental	
Protection	IP67
Corrosion	5% NaCl for 96hrs
Temperature Range	-40°C to +85°C
Thermal Shock	100 cycles -40°C to +85°C
Humidity	Non-condensing 65°C 95% RH
Shock (Drop Test)	1m drop on concrete 6 axes
Cable Pull	8 Kgf

Tested with 1.5m of cable and with the additional 1.5m cable assembly.

5G/4G Bands			
Band Number	5GNR / FR1 / LTE / LTE-Advanced / WCDMA / HSPA / HSPA+ / TD-SCDMA		
	Uplink	Downlink	Covered
1	UL: 1920 to 1980	DL: 2110 to 2170	✓
2	UL: 1850 to 1910	DL: 1930 to 1990	✓
3	UL: 1710 to 1785	DL: 1805 to 1880	✓
4	UL: 1710 to 1755	DL: 2110 to 2155	✓
5	UL: 824 to 849	DL: 869 to 894	✓
7	UL: 2500 to 2570	DL: 2620 to 2690	✓
8	UL: 880 to 915	DL: 925 to 960	✓
9	UL: 1749.9 to 1784.9	DL: 1844.9 to 1879.9	✓
11	UL: 1427.9 to 1447.9	DL: 1475.9 to 1495.9	✓
12	UL: 699 to 716	DL: 729 to 746	✓
13	UL: 777 to 787	DL: 746 to 756	✓
14	UL: 788 to 798	DL: 758 to 768	✓
17	UL: 704 to 716	DL: 734 to 746	✓
18	UL: 815 to 830	DL: 860 to 875	✓
19	UL: 830 to 845	DL: 875 to 890	✓
20	UL: 832 to 862	DL: 791 to 821	✓
21	UL: 1447.9 to 1462.9	DL: 1495.9 to 1510.9	✓
22	UL: 3410 to 3490	DL: 3510 to 3590	✓
23	UL: 2000 to 2020	DL: 2180 to 2200	✓
24	UL: 1625.5 to 1660.5	DL: 1525 to 1559	✓
25	UL: 1850 to 1915	DL: 1930 to 1995	✓
26	UL: 814 to 849	DL: 859 to 894	✓
27	UL: 807 to 824	DL: 852 to 869	✓
28	UL: 703 to 748	DL: 758 to 803	✓
29	UL: -	DL: 717 to 728	✓
30	UL: 2305 to 2315	DL: 2350 to 2360	✓
31	UL: 452.5 to 457.5	DL: 462.5 to 467.5	✗
32	UL: -	DL: 1452 – 1496	✓
35		1850 to 1910	✓
38		2570 to 2620	✓
39		1880 to 1920	✓
40		2300 to 2400	✓
41		2496 to 2690	✓
42		3400 to 3600	✗
43		3600 to 3800	✗
48		3550 to 3700	✗
66	UL: 1710-1780	DL: 2110-2200	✗
71		617 to 698	✗
74/75/76		1427 to 1518	✓
77		3300 to 4200	✗
78		3300 to 3800	✗
79		4400 to 5000	✗

3. Antenna Characteristics

3.1 Return Loss

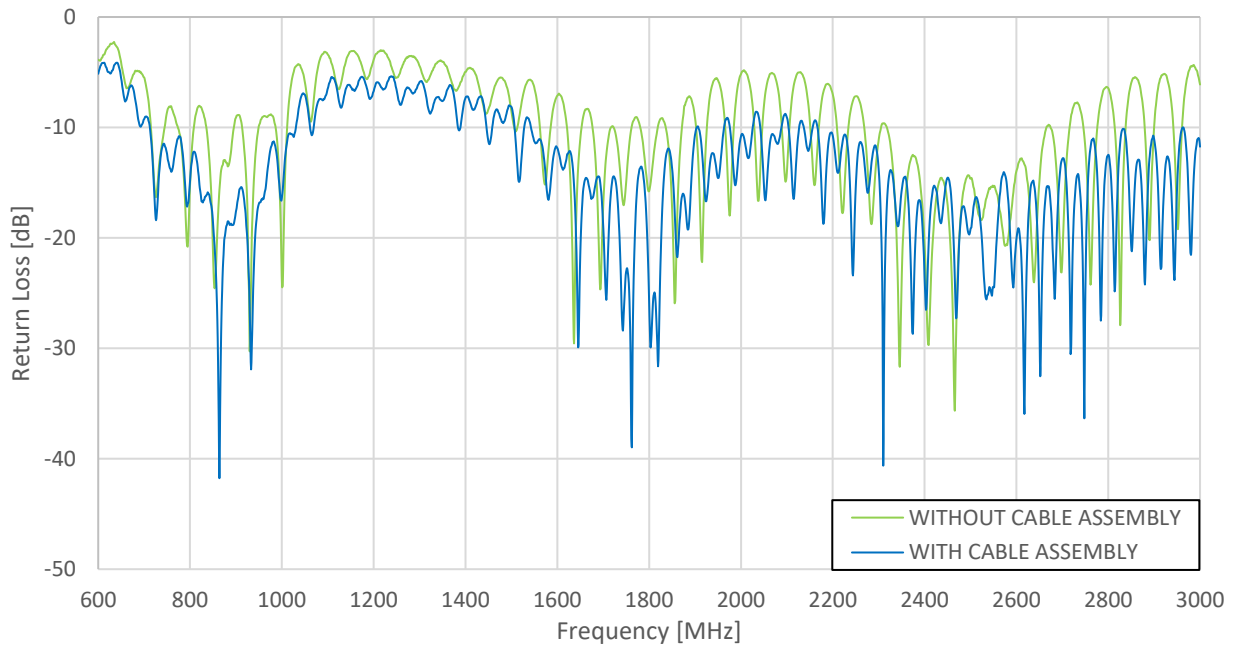

3.2 VSWR

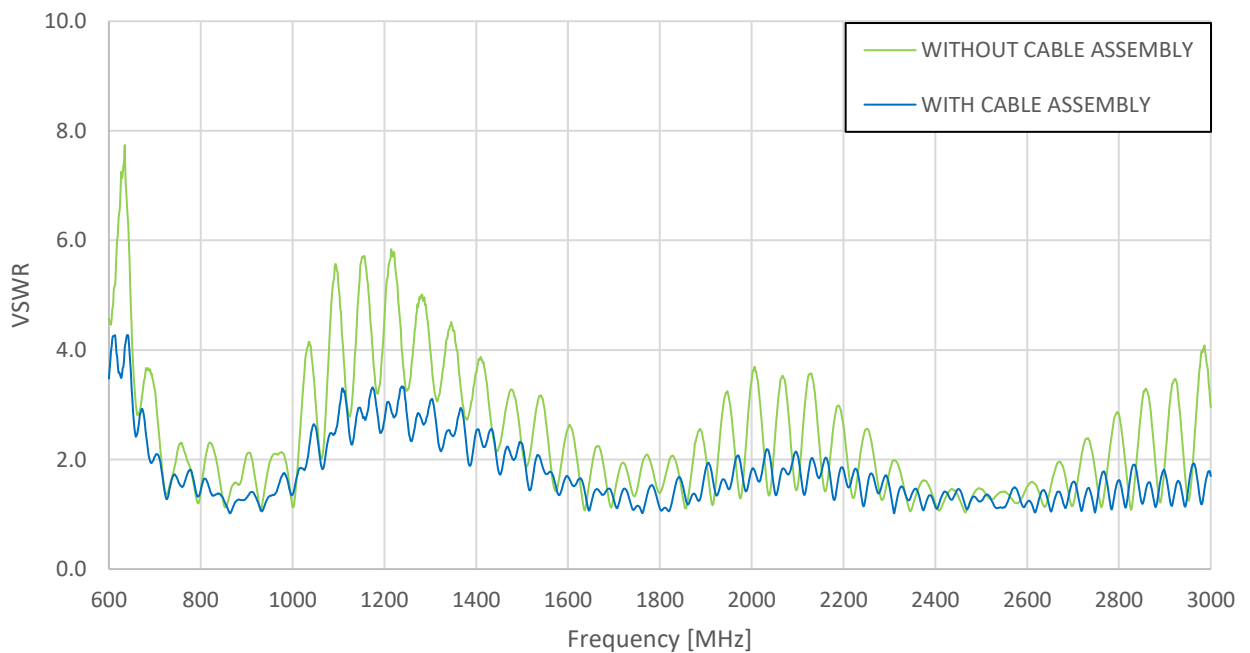

3.3 Efficiency

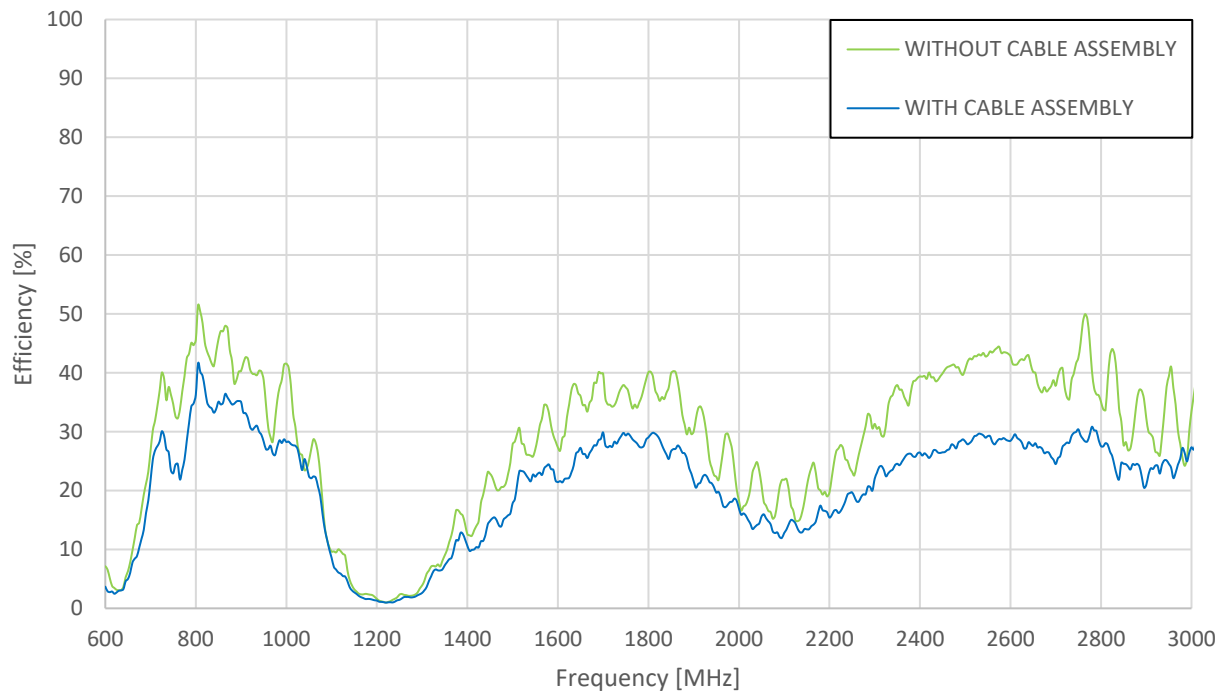

3.4 Peak Gain

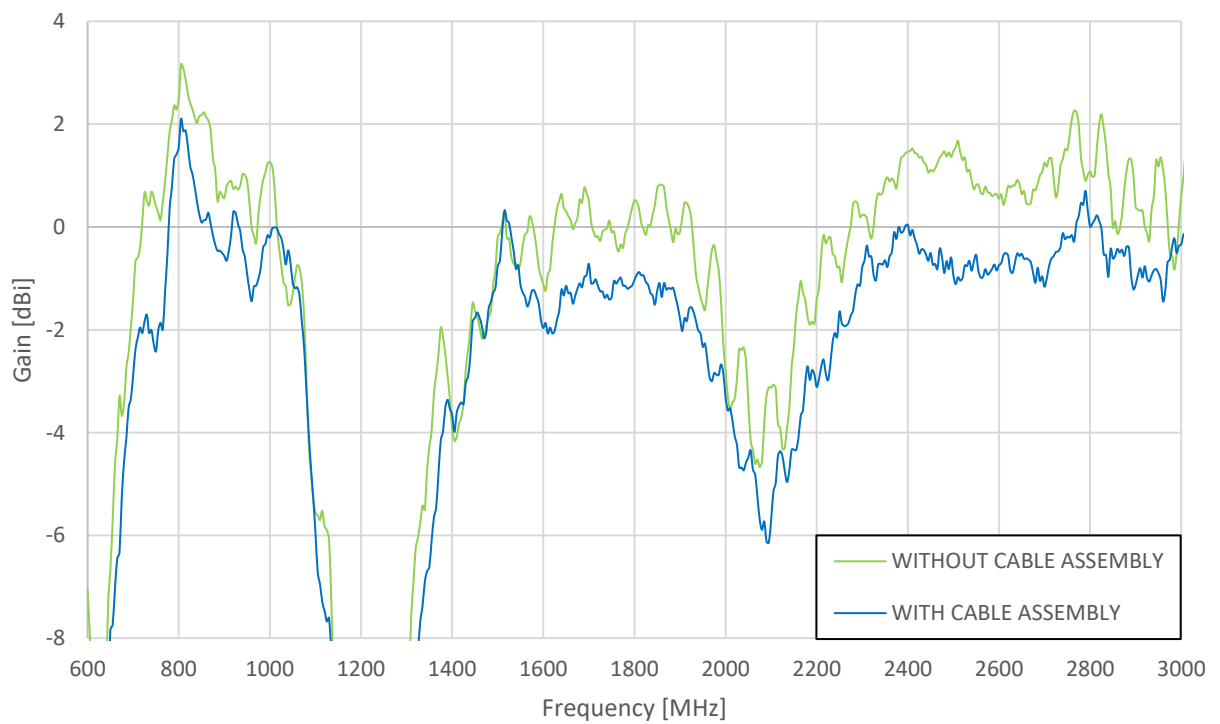

3.5 Average Gain

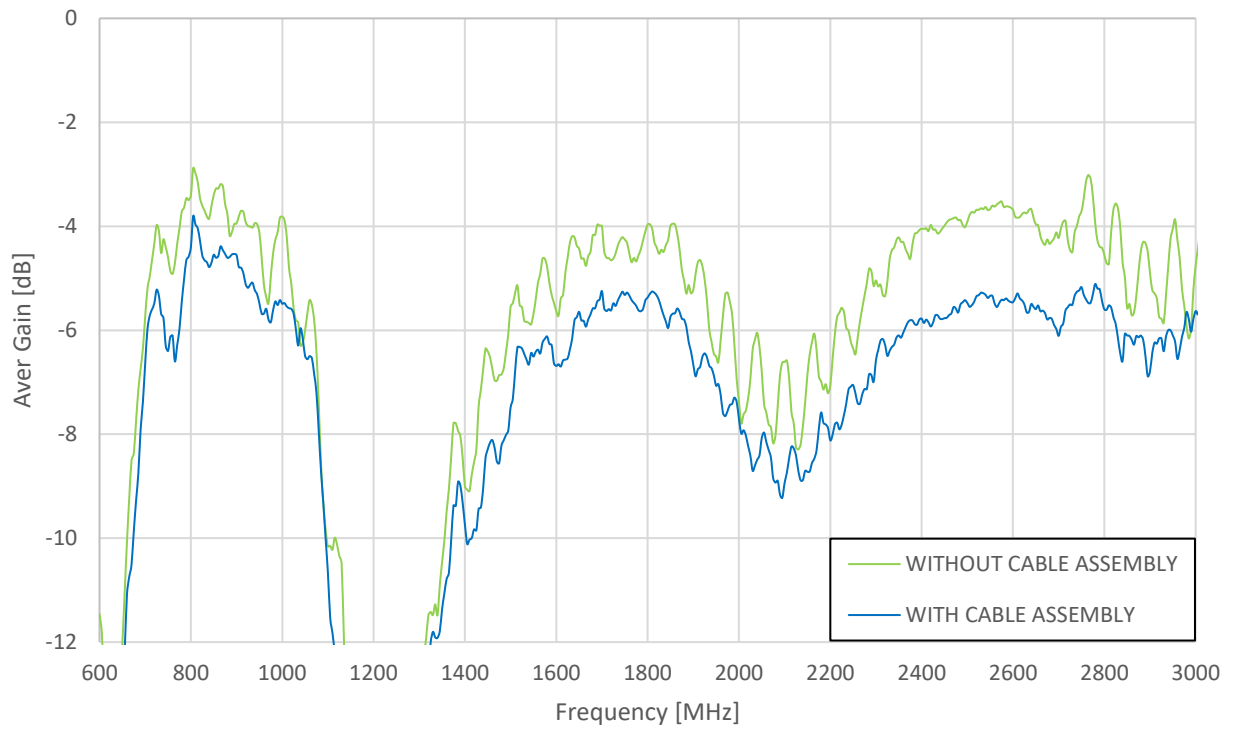

4. Radiation Patterns

4.1 Test Setup



Chamber Set up

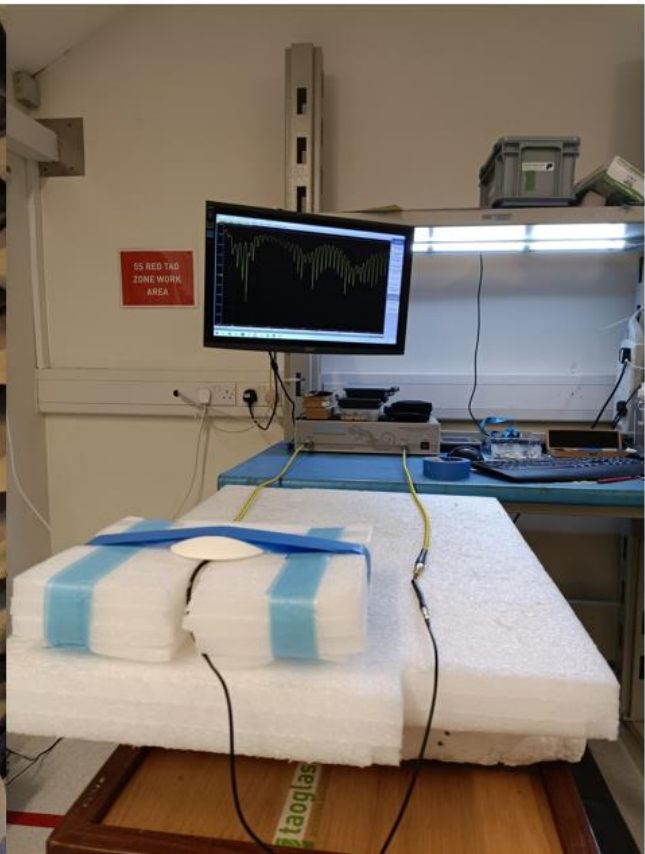

VNA Set up

4.2 700MHz 3D and 2D Radiation Patterns (Without Cable Assembly)

Azimuth = 0.0
Elevation = 0.0
Roll = -35.0

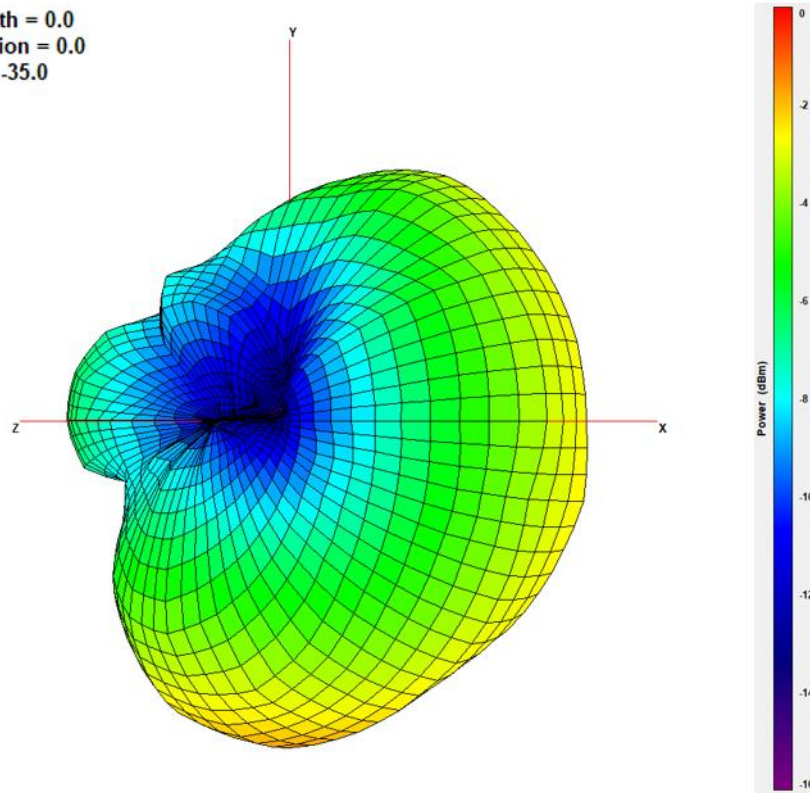

XY Plane XZ Plane YZ Plane

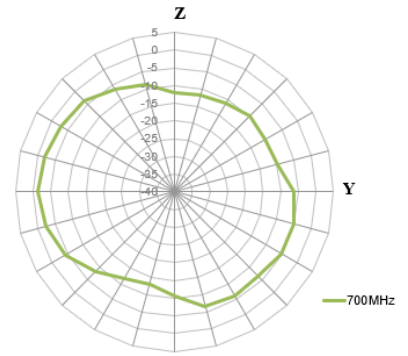
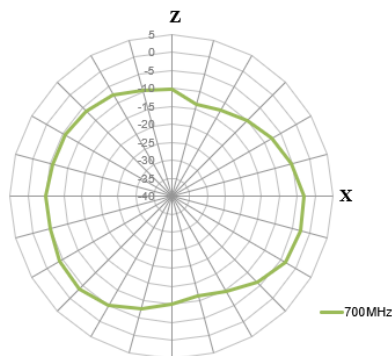
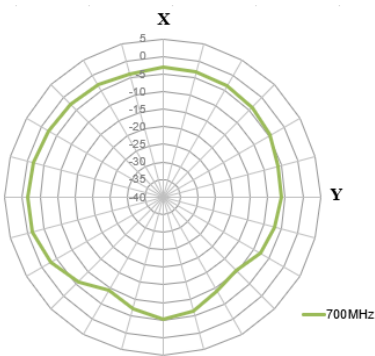

850MHz

Azimuth = 0.0
Elevation = 0.0
Roll = -35.0

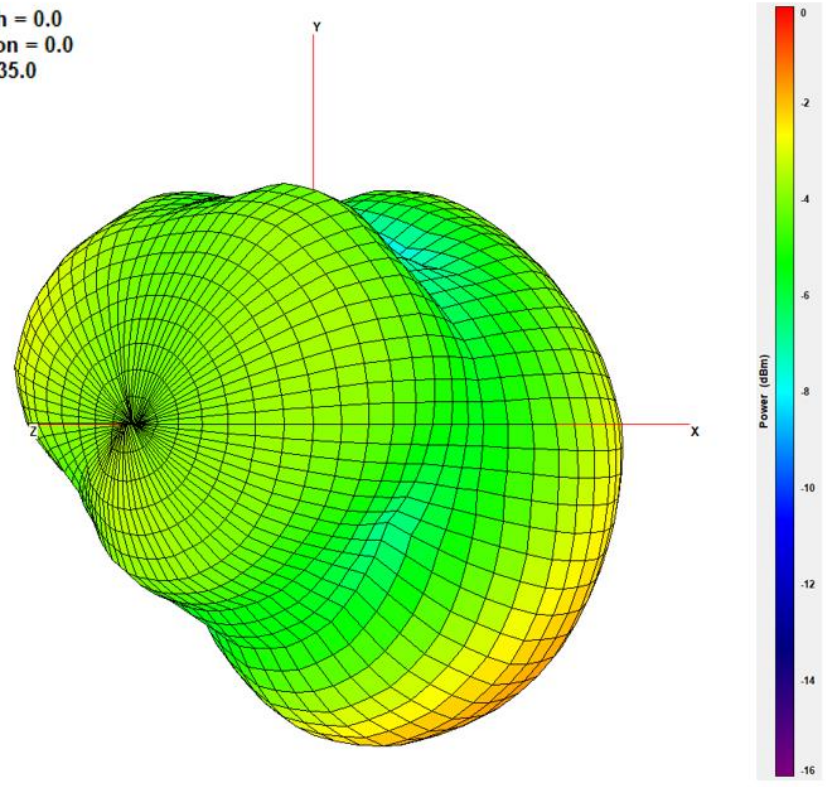

XY Plane

XZ Plane

YZ Plane

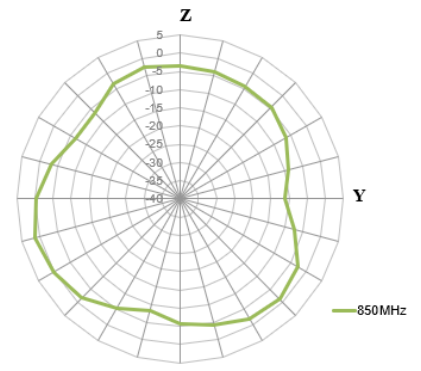
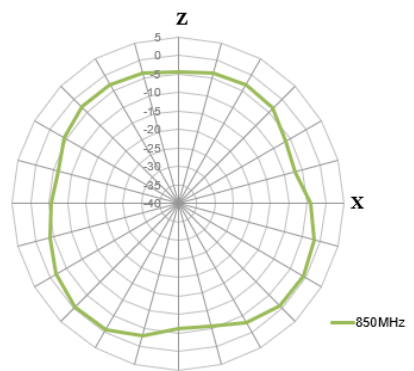
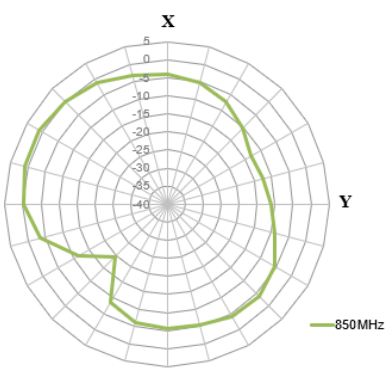

900MHz

Azimuth = 0.0
Elevation = 0.0
Roll = -35.0

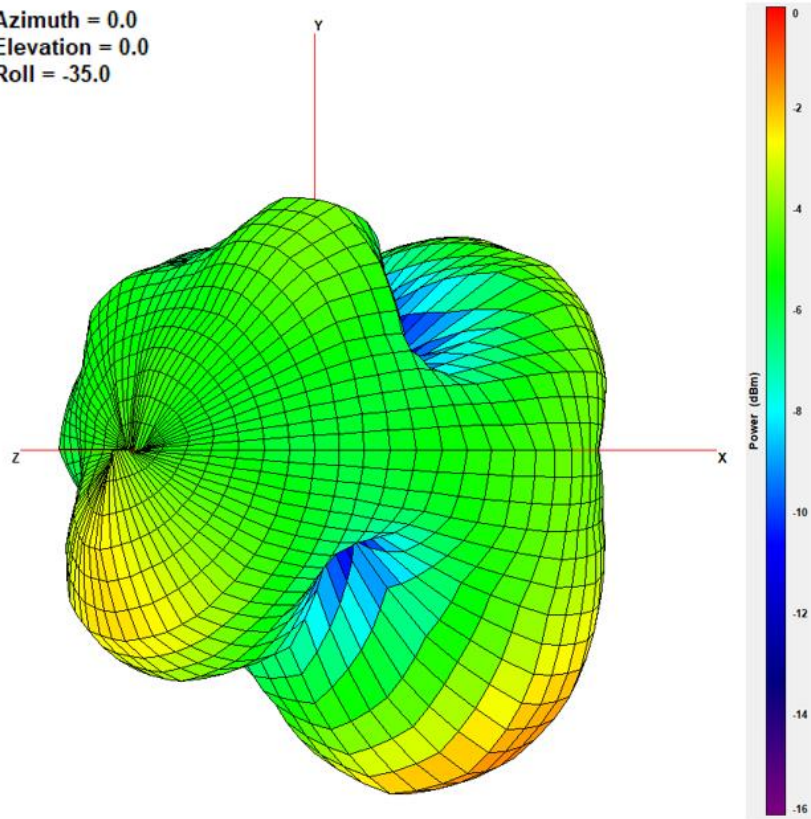

XY Plane

XZ Plane

YZ Plane

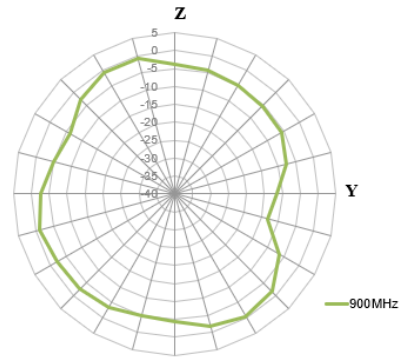
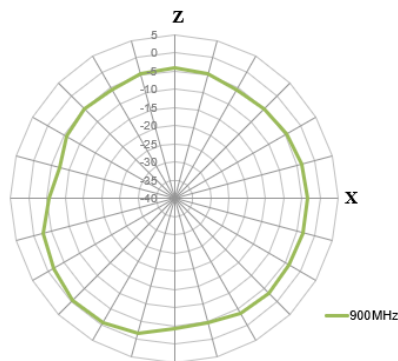
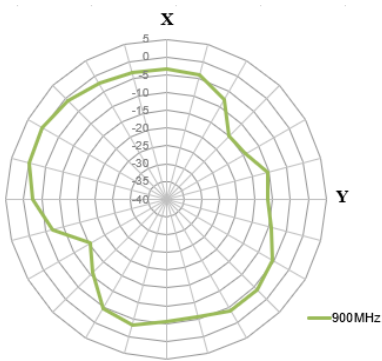

1710MHz

Azimuth = 0.0
Elevation = 0.0
Roll = -35.0

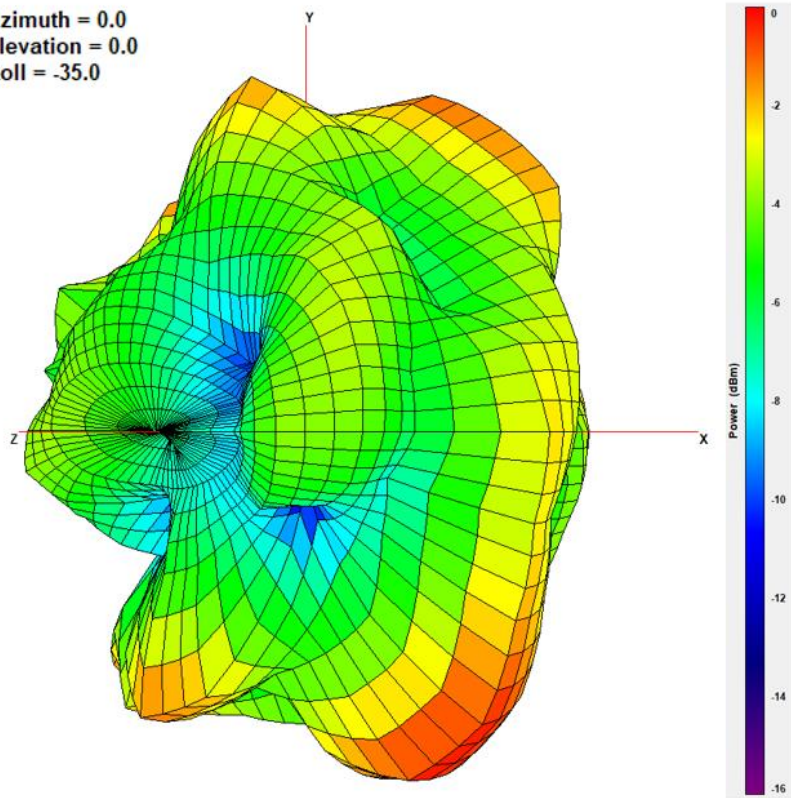

XY Plane

XZ Plane

YZ Plane

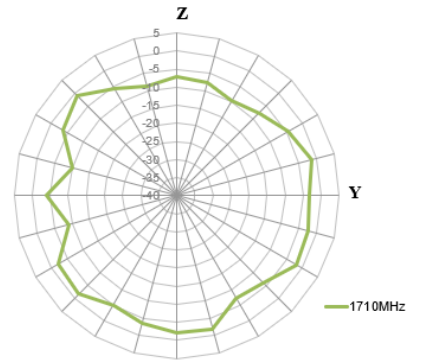
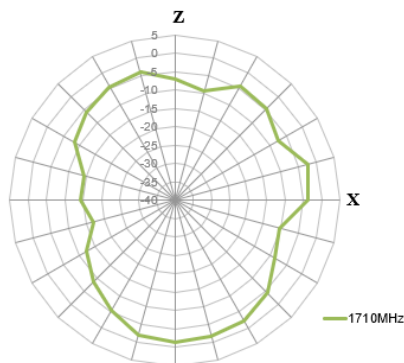
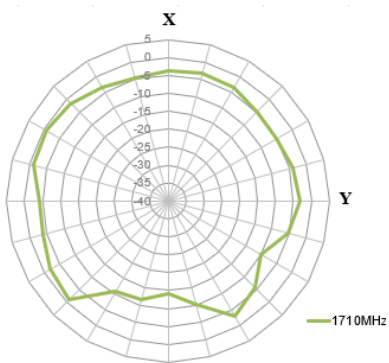

1800MHz

Azimuth = 0.0
Elevation = 0.0
Roll = -35.0

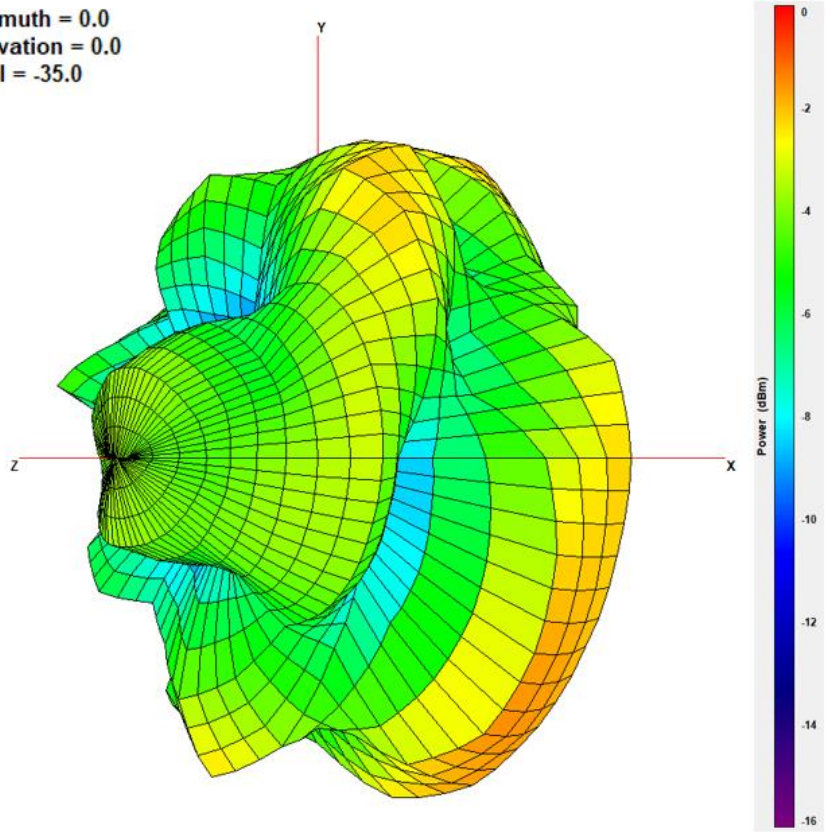

XY Plane

XZ Plane

YZ Plane

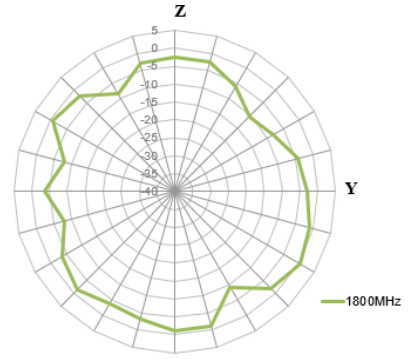
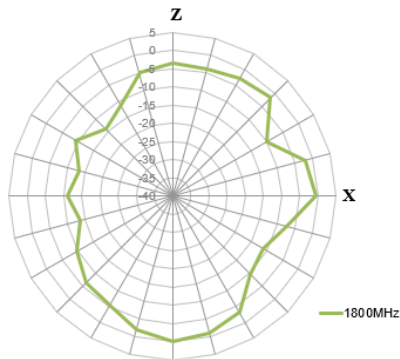
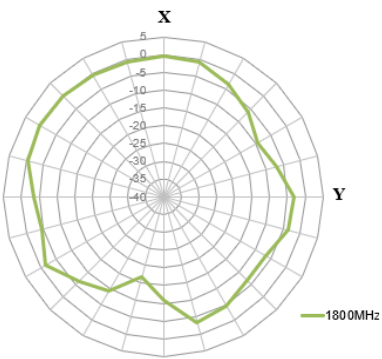

1910MHz

Azimuth = 0.0
Elevation = 0.0
Roll = -35.0

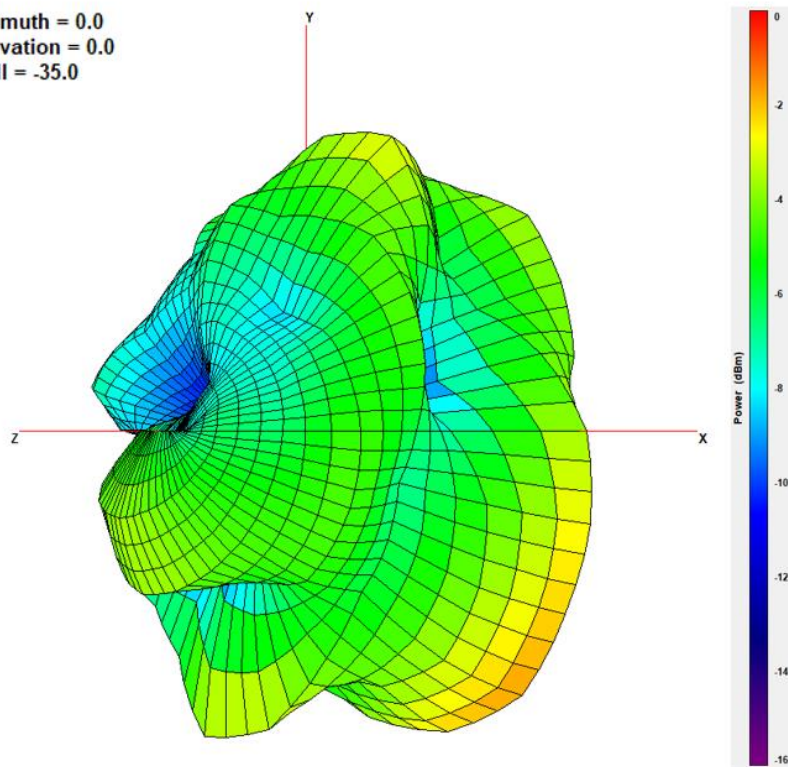

XY Plane

XZ Plane

YZ Plane

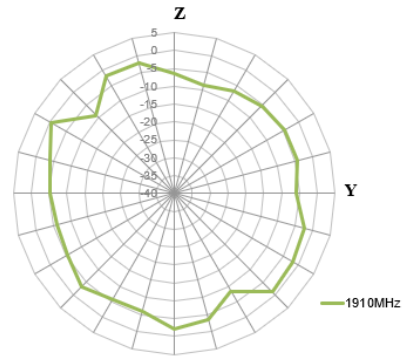
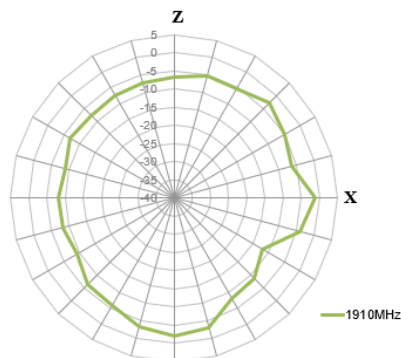
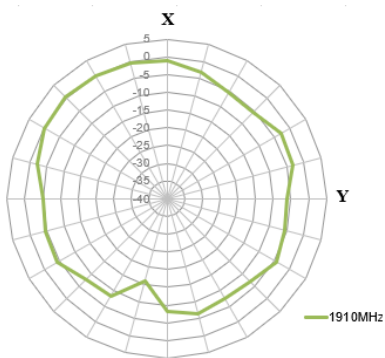

2450MHz

Azimuth = 0.0
Elevation = 0.0
Roll = -35.0

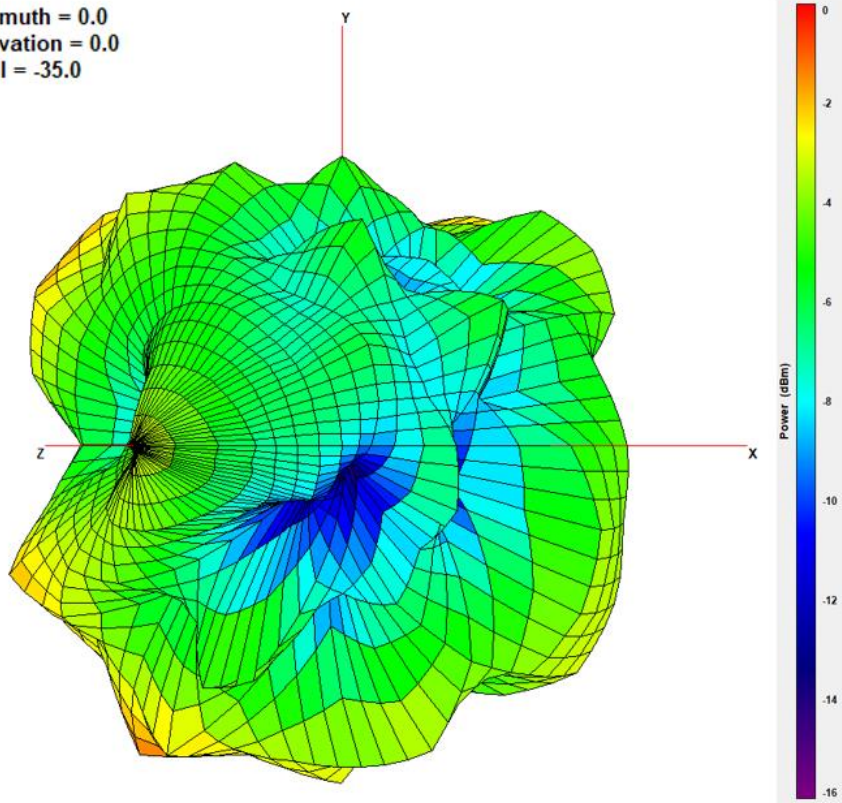

XY Plane

XZ Plane

YZ Plane

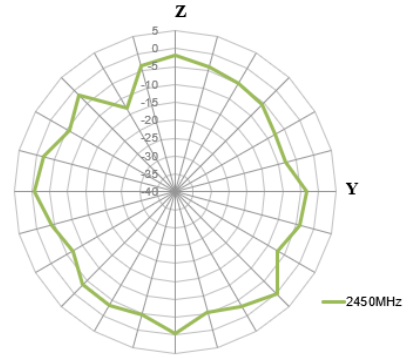
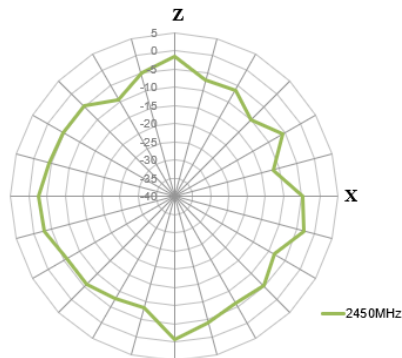
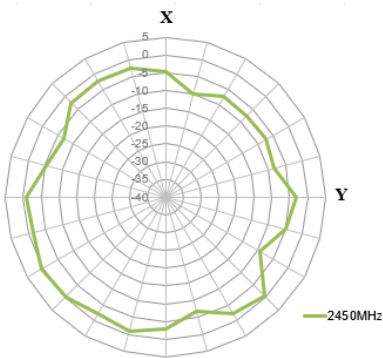

2500MHz

Azimuth = 0.0
 Elevation = 0.0
 Roll = -35.0

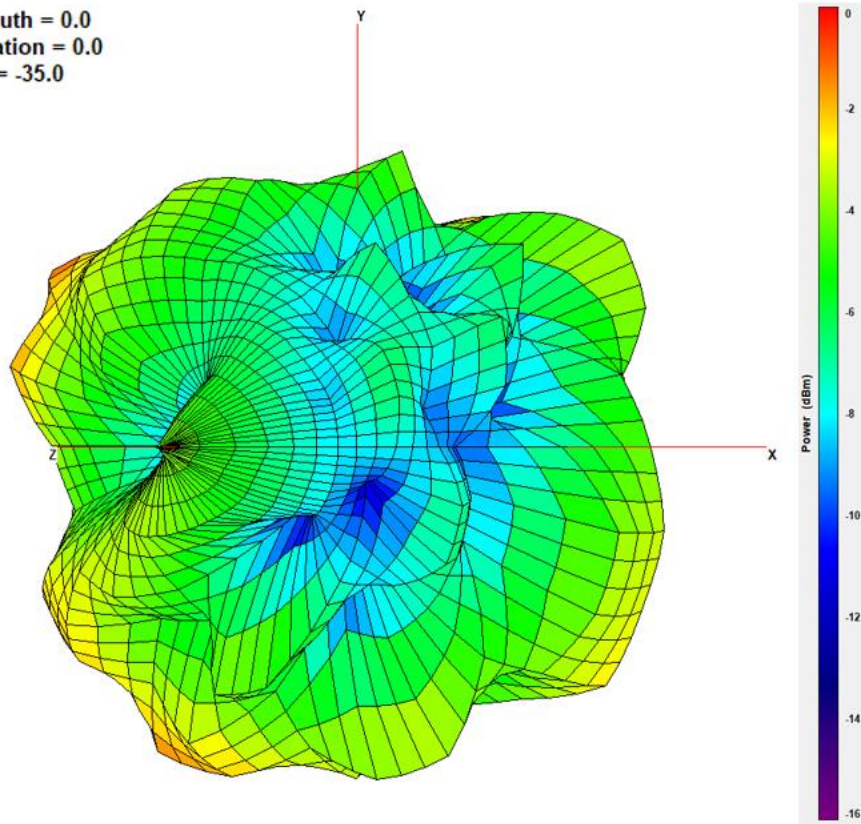

XY Plane

XZ Plane

YZ Plane

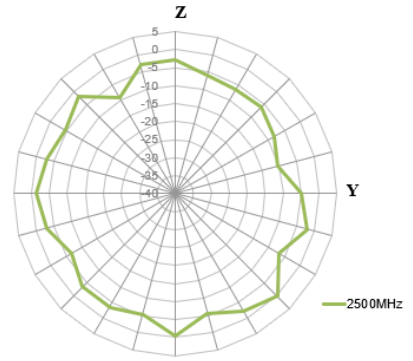
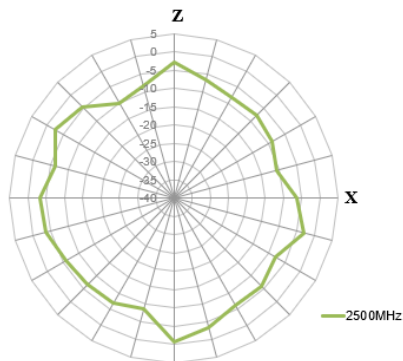
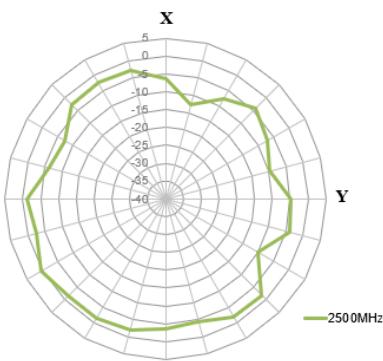

2600MHz

Azimuth = 0.0
Elevation = 0.0
Roll = -35.0

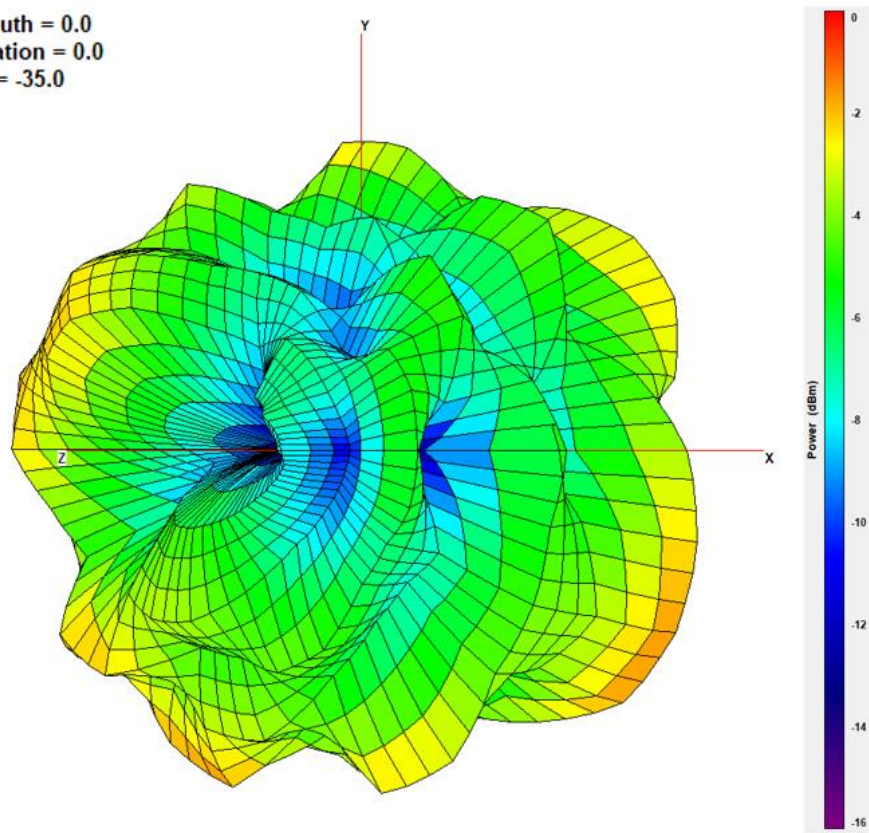

XY Plane

XZ Plane

YZ Plane

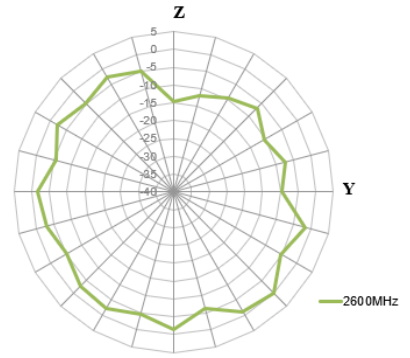
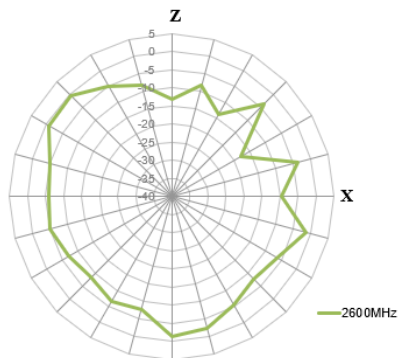
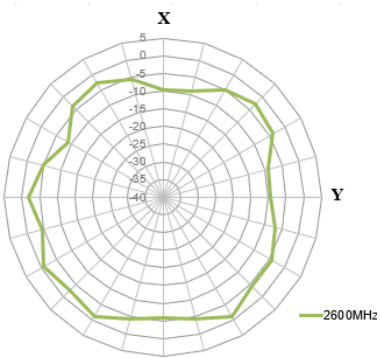

4.3 700MHz 3D and 2D Radiation Patterns (With Cable Assembly)

Azimuth = 0.0
 Elevation = 0.0
 Roll = -35.0

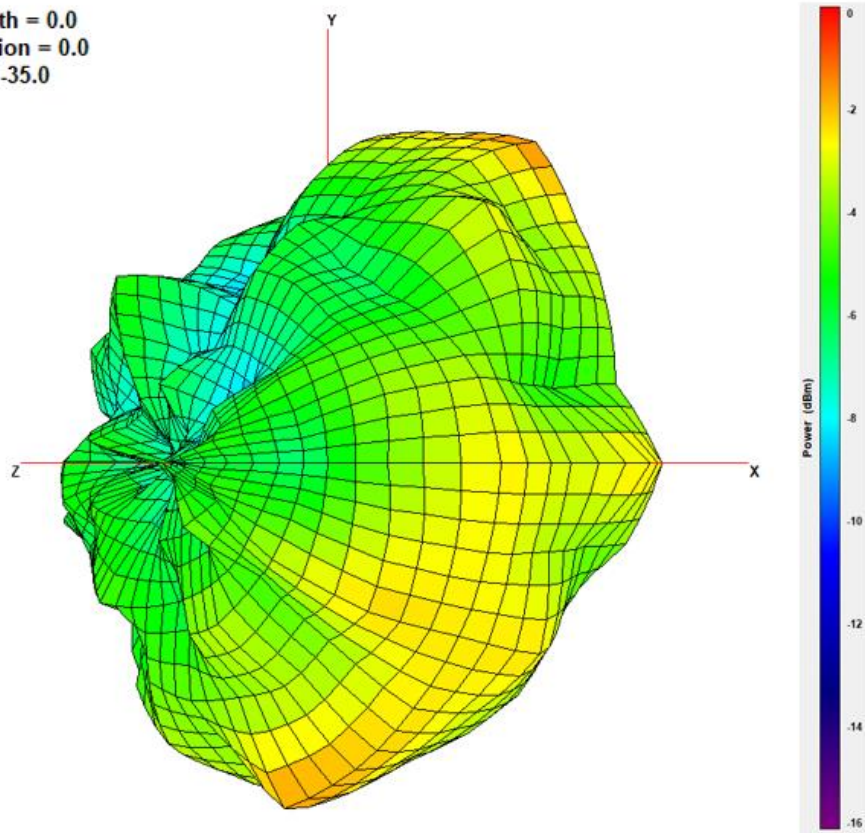

XY Plane

XZ Plane

YZ Plane

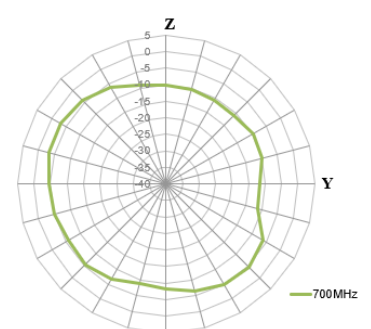
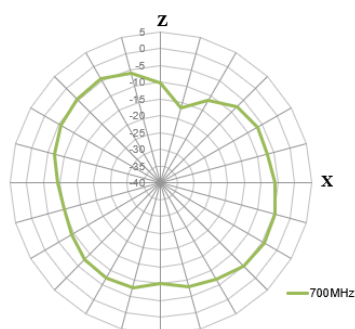
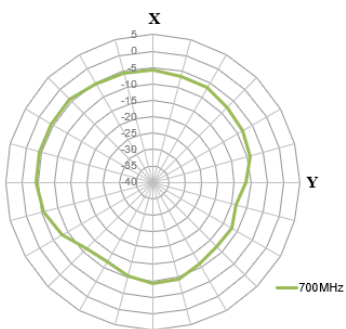

850MHz

Azimuth = 0.0
Elevation = 0.0
Roll = -35.0

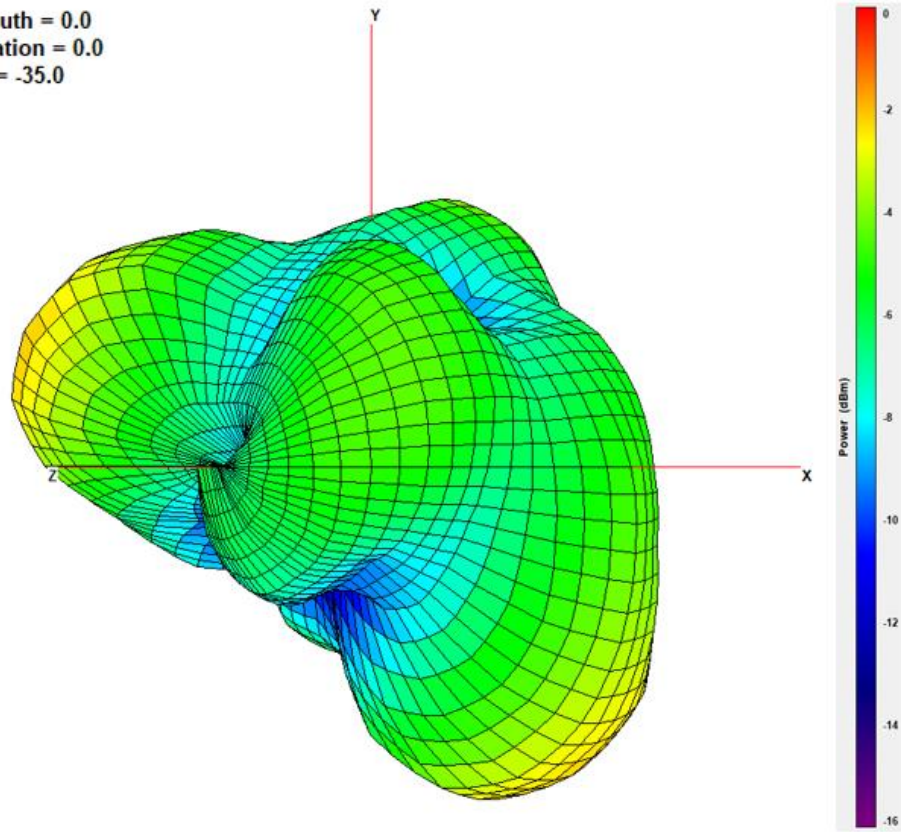

XY Plane

XZ Plane

YZ Plane

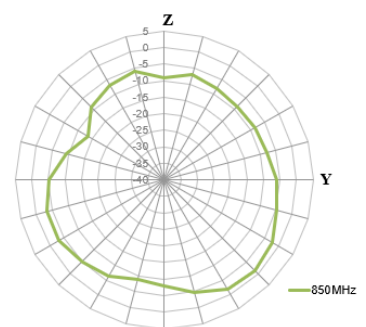
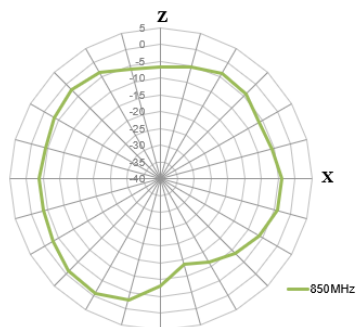
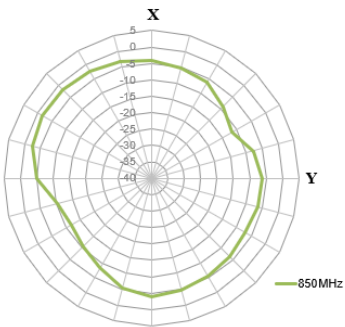

900MHz

Azimuth = 0.0
Elevation = 0.0
Roll = -35.0

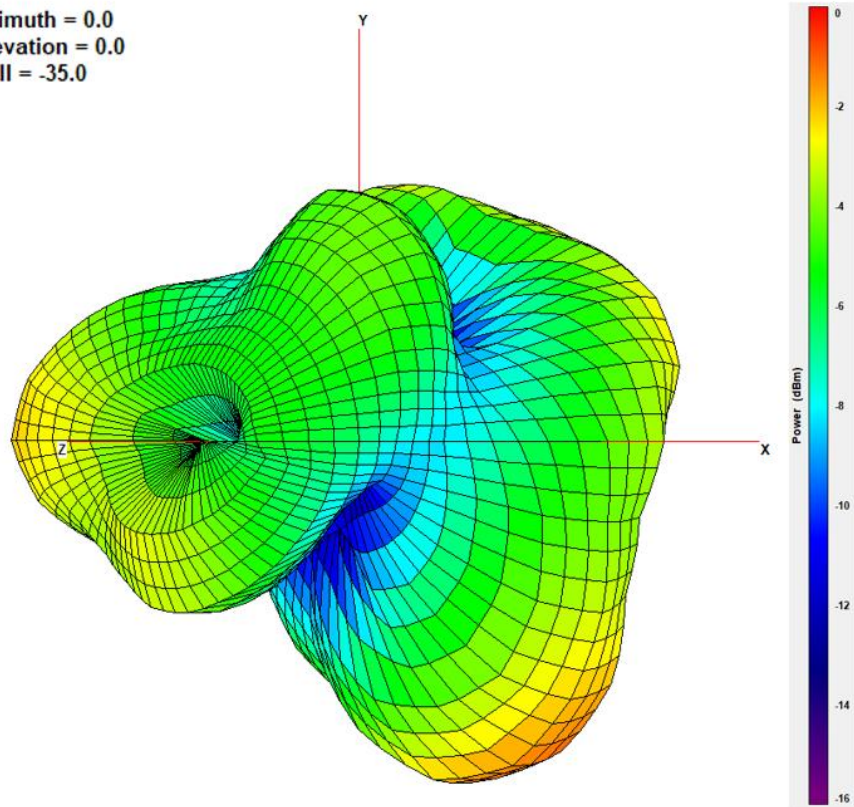

XY Plane

XZ Plane

YZ Plane

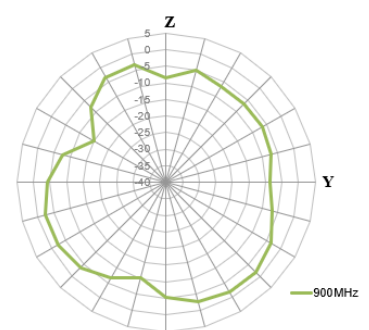
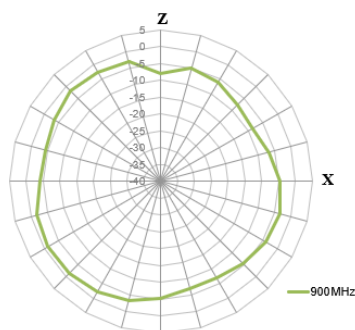
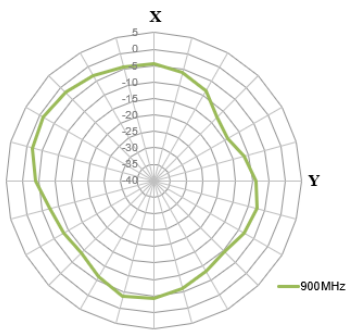

1710MHz

Azimuth = 0.0
 Elevation = 0.0
 Roll = -35.0

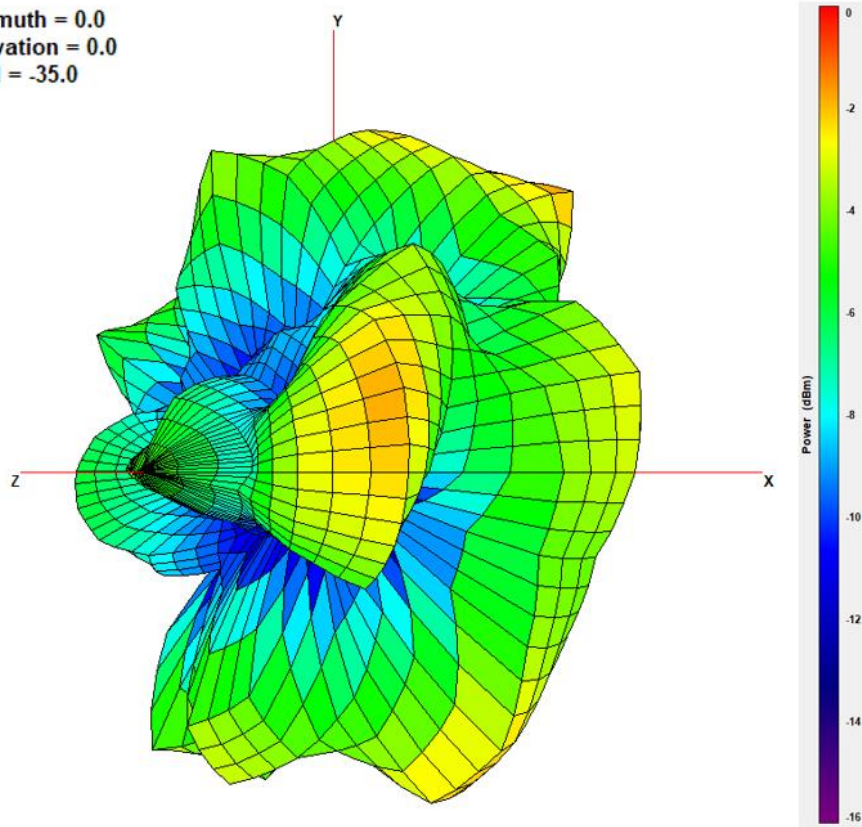

XY Plane

XZ Plane

YZ Plane

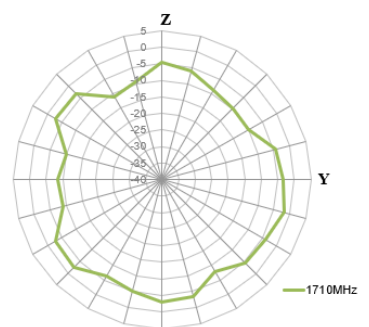
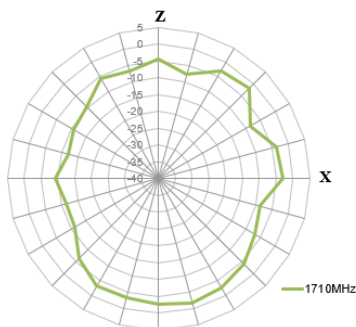
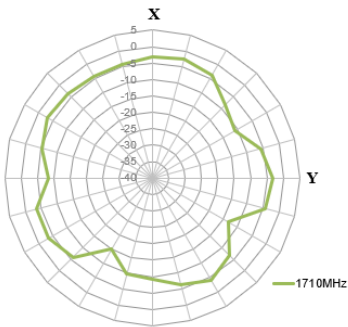

1800MHz

Azimuth = 0.0
Elevation = 0.0
Roll = -35.0

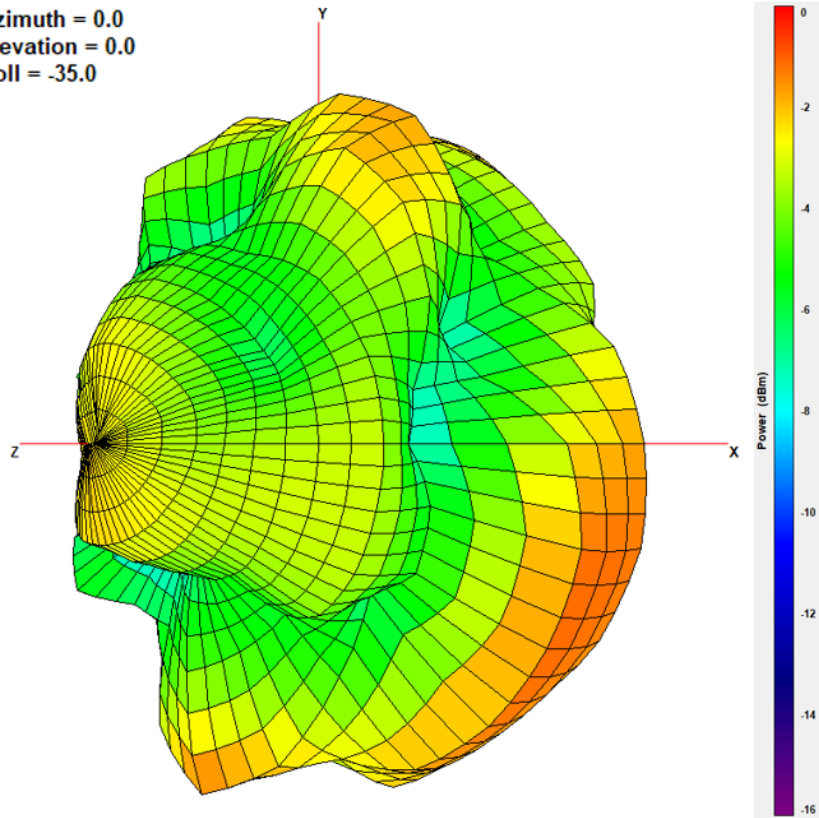

XY Plane

XZ Plane

YZ Plane

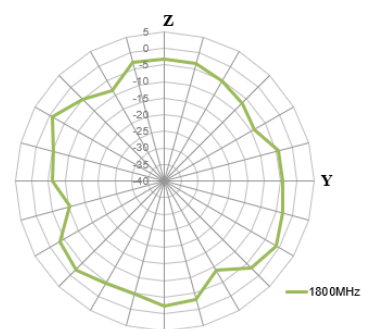
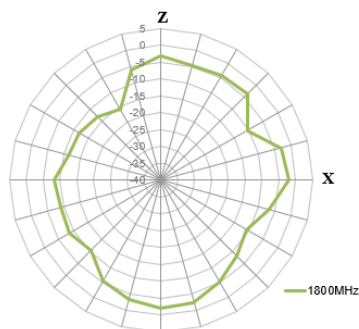
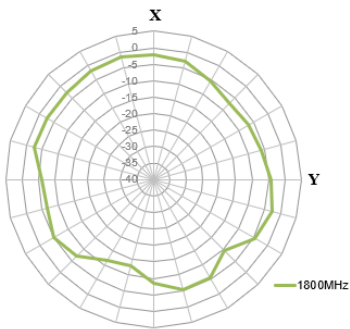

1910MHz

Azimuth = 0.0
 Elevation = 0.0
 Roll = -35.0

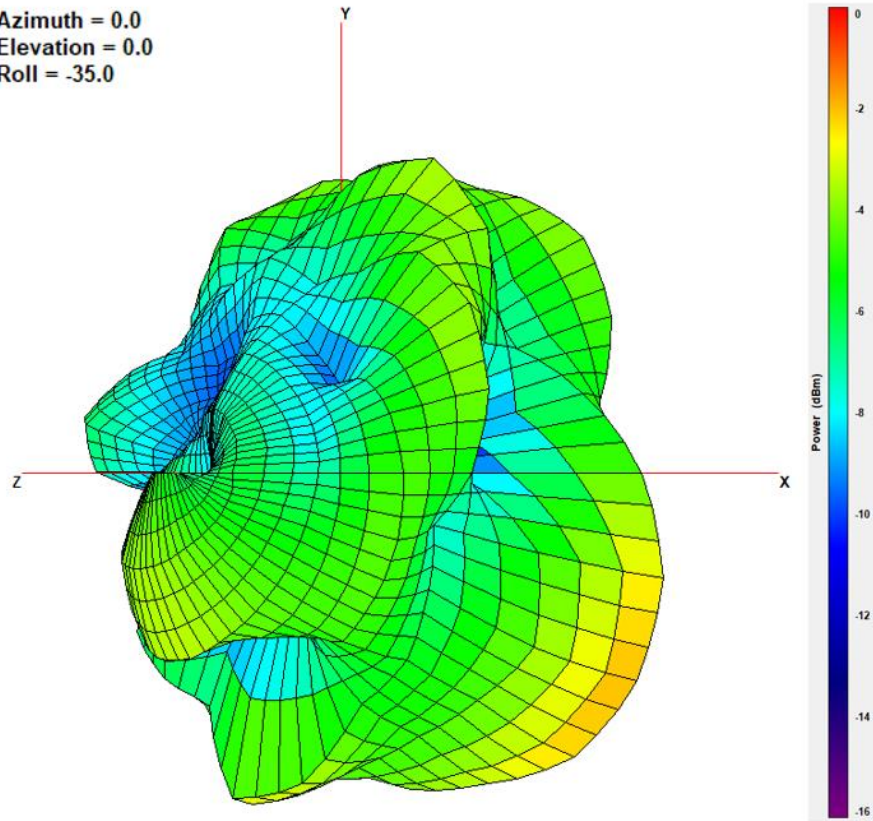

XY Plane

XZ Plane

YZ Plane

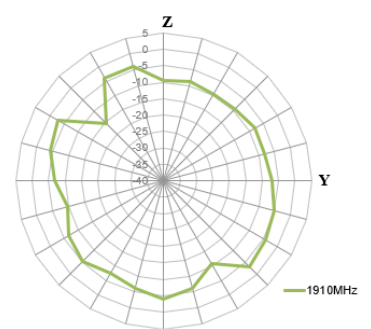
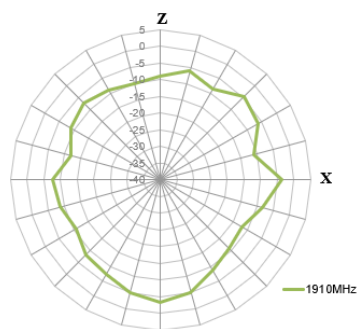
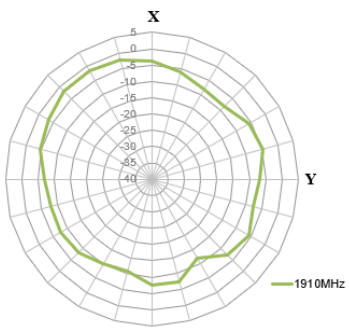

2450MHz

Azimuth = 0.0
Elevation = 0.0
Roll = -35.0

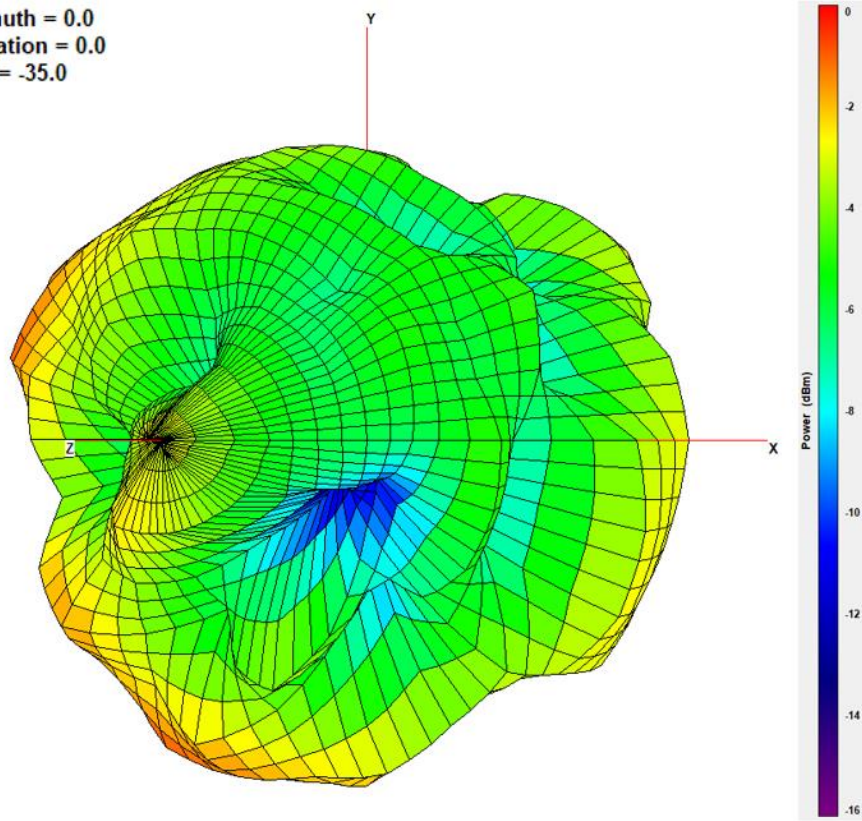

XY Plane

XZ Plane

YZ Plane

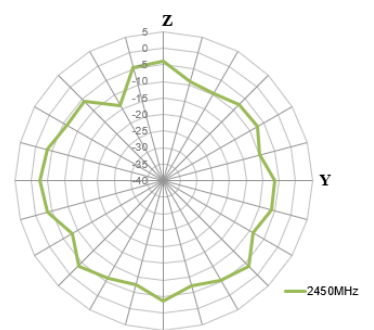
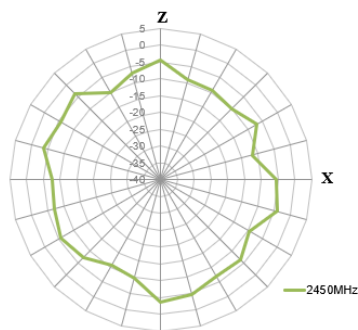
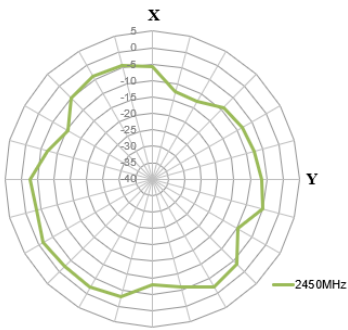

2500MHz

Azimuth = 0.0
 Elevation = 0.0
 Roll = -35.0

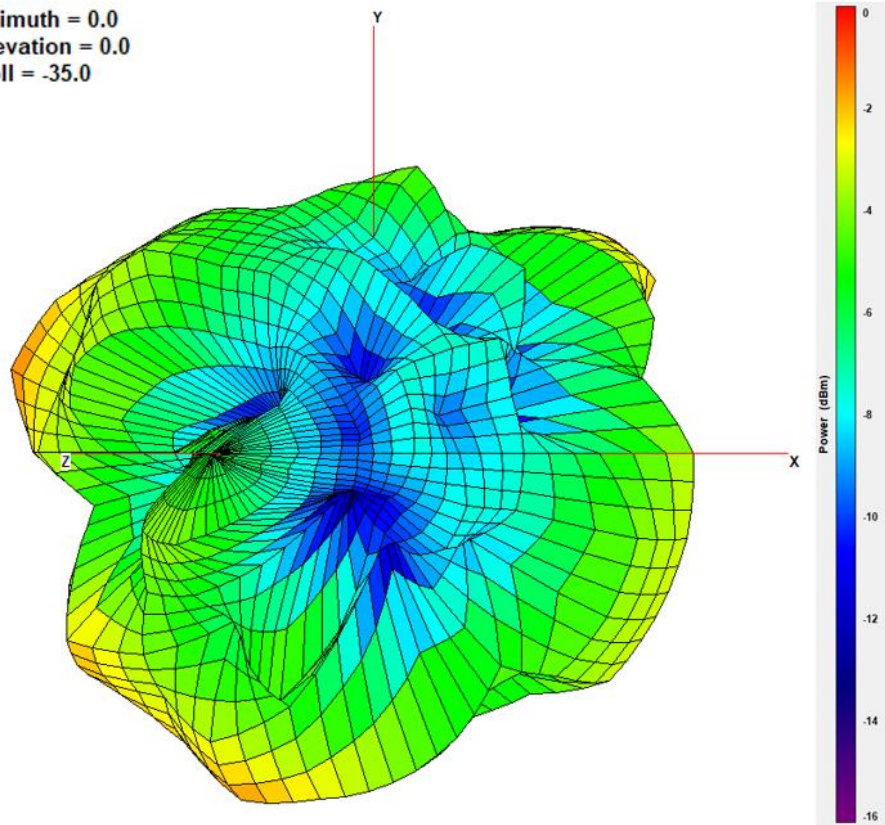

XY Plane

XZ Plane

YZ Plane

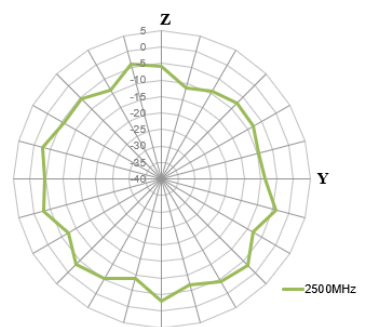
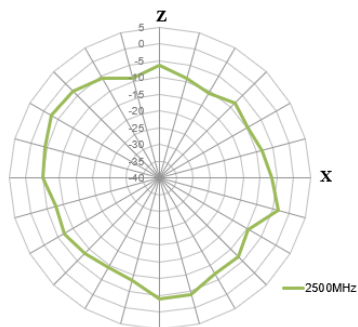
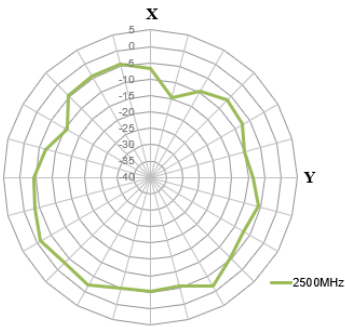

2600MHz

Azimuth = 0.0
Elevation = 0.0
Roll = -35.0

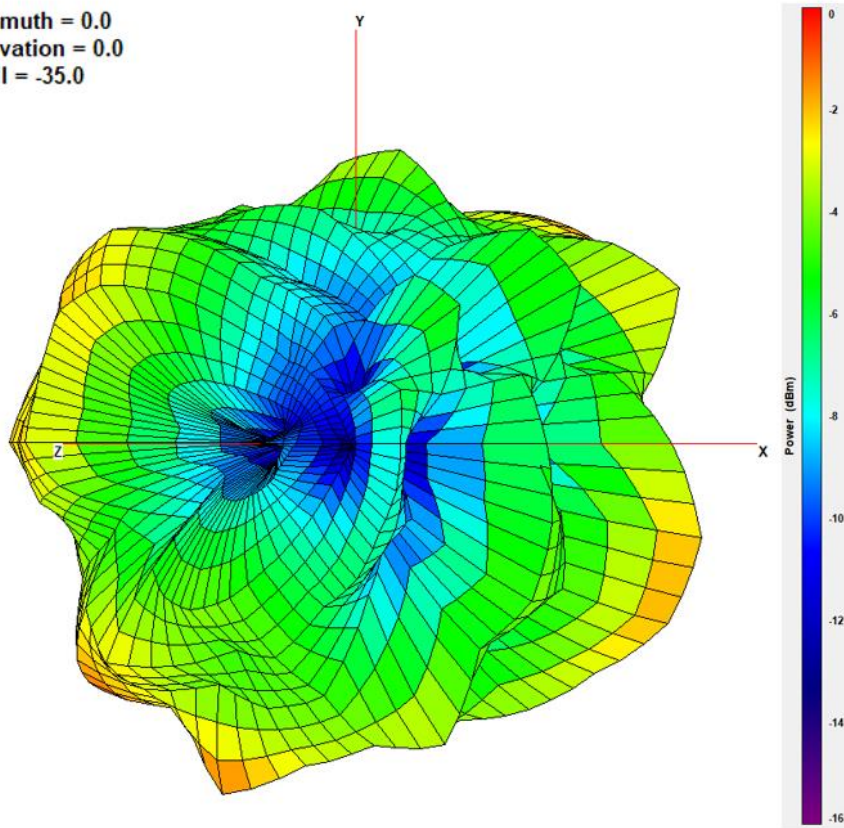

XY Plane

XZ Plane

YZ Plane

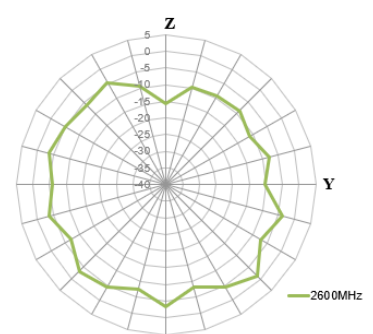
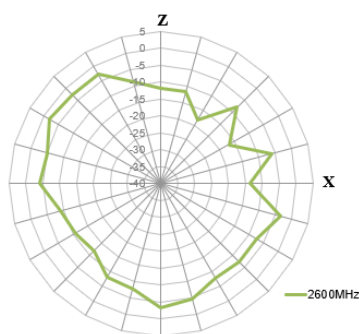
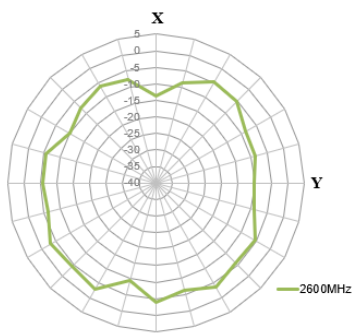

5. Mechanical Drawing – Roadmarker

Top View

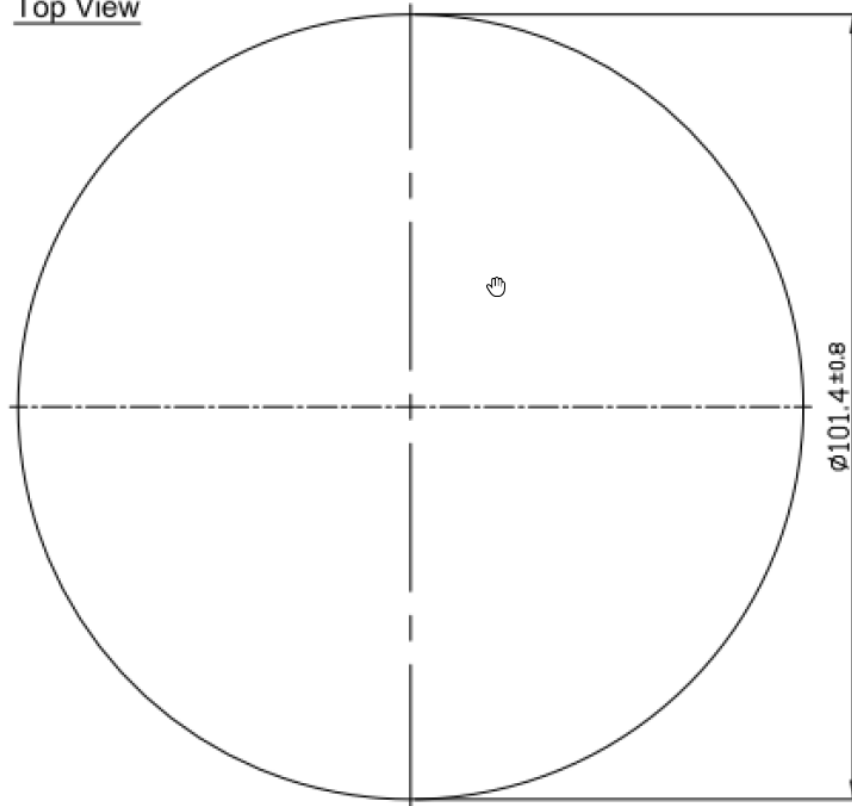

Front View

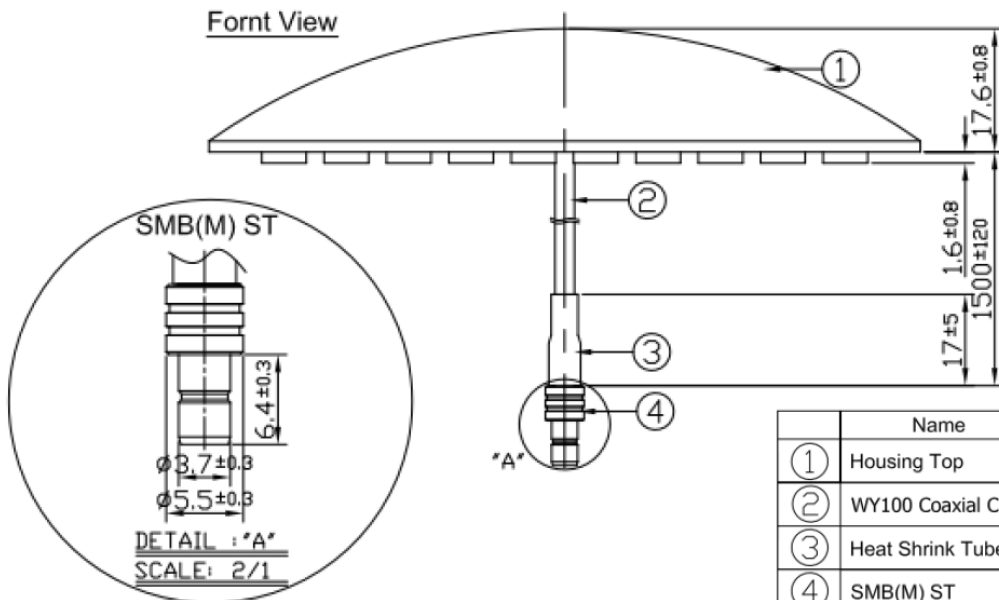

	Name	Material	Finish	QTY
①	Housing Top	PP	White	1
②	WY100 Coaxial Cable	PVC	Black	1
③	Heat Shrink Tube	PE	Black	1
④	SMB(M) ST	Brass	Gold	1

6. Mechanical Drawing – Cable Assembly

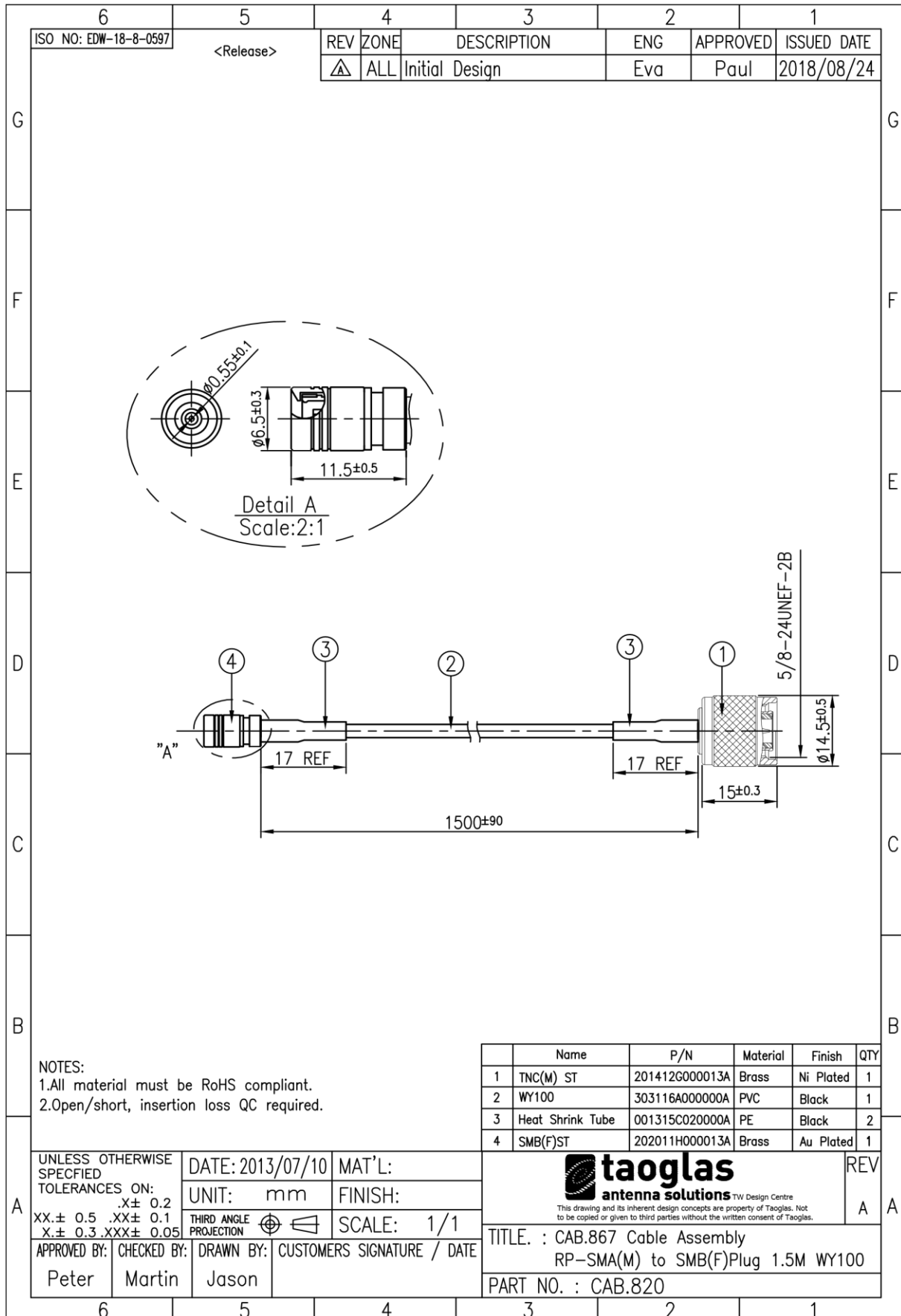

7. Packaging

1pcs RG.02.02.3000W per carton
 Dimensions - 350*340*47mm
 Weight - 92g

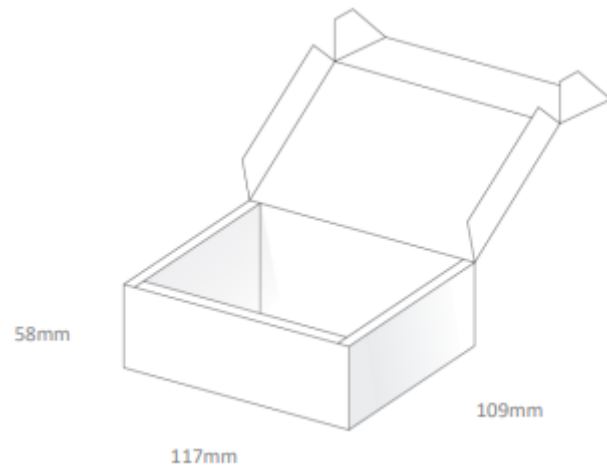

24pcs RG.02.02.3000W per carton
 Dimensions - 589*296*135mm
 Weight - 2.4Kg

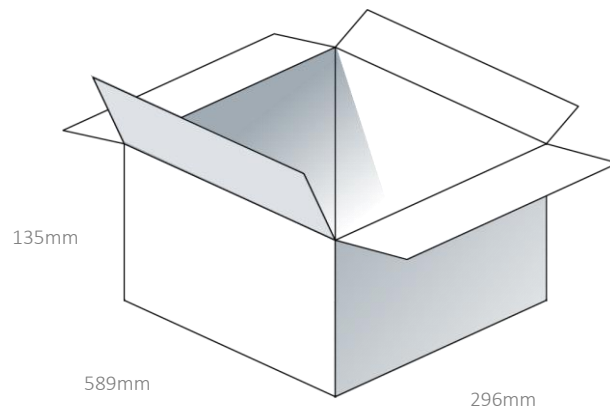

Changelog for the datasheet

SPE-14-8-038 – RG.02.02.3000W

Revision: F (Current Version)

Date:	2022-01-24
Changes:	Updated data.
Changes Made by:	Gary West

Previous Revisions

Revision: E

Date:	2020-01-23
Changes:	Updated data to show 4G
Changes Made by:	Jack Conroy

Revision: D

Date:	2017-01-08
Changes:	Updated to remove reference to manhole covers as per request by KB. Also added disclaimer
Changes Made by:	Andy Mahoney

Revision: C

Date:	2014-05-16
Changes:	
Changes Made by:	Aine Doyle

Revision: B

Date:	2014-04-23
Changes:	
Changes Made by:	Aine Doyle

Revision: A (Original First Release)

Date:	2014-08-17
Notes:	
Author:	Aine Doyle



TAOGLAS®

www.taoglas.com

