

Electro-pneumatic control valves

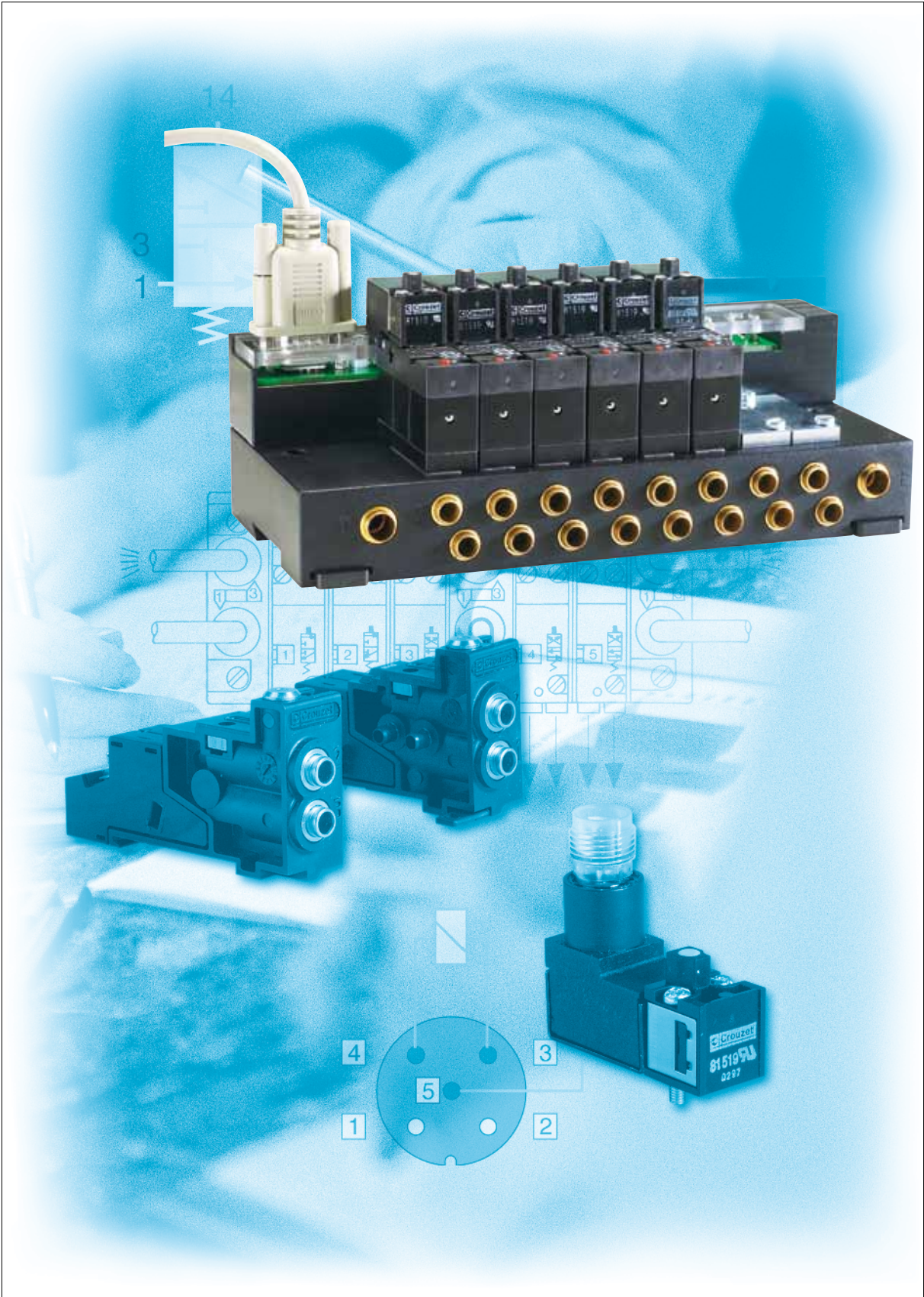

Miniature solenoid valves for alternating current

- Conform to the Low Voltage Directive
- For mounting on sub-base or footprint in accordance with CNOMO recommendation E-06-36-120N

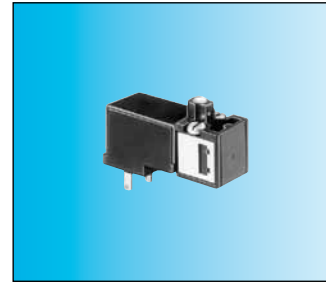

Part numbers (and voltages)

| Consumption | Voltage | 81 519 080 | 81 519 380 | 81 519 680 |
|-------------|-------------------------|-------------------------|---------------------------------|---|
| 2.5 VA | 24 V ~ 50-60 Hz | — | 81 519 381 | — |
| 2.5 VA | 48 V ~ 50-60 Hz* | — | 81 519 378 | 81 519 678 |
| 2.5 VA | 110 V ~ 50-60 Hz | — | 81 519 379 | 81 519 679 |
| 2.5 VA | 220 V- 230 V ~ 50-60 Hz | — | — | — |
| Function | | 3/2 NC | 3/2 NC | 3/2 NC |
| Version | | Without manual override | With manual override by impulse | With manual override by latching (1/4 turn) |

Characteristics

| | | | | |
|---|---------|-------------------|-------------------|-------------------|
| Operating pressure | bar | 1 → 8 | 1 → 8 | 1 → 8 |
| Orifice diameter | mm | 0.5 | 0.5 | 0.5 |
| Flow at 6 bars | NI/min | 12 | 12 | 12 |
| kV | | 0.12 | 0.12 | 0.12 |
| Switching time | ms | 5 → 15 | 5 → 15 | 5 → 15 |
| Mechanical life (operations) | | 5 10 ⁷ | 5 10 ⁷ | 5 10 ⁷ |
| Operating temperature | °C | -10 → +50 | -10 → +50 | -10 → +50 |
| Compressed air or inert gas - oil-free air filtered to 50 µ | | ● | ● | ● |
| Duty factor | | 100 % ED | 100 % ED | 100 % ED |
| Insulation class | IEC 85 | F | F | F |
| Weight | | 35 | 35 | 35 |
| Rotatable connector 4 positions in 90° steps | | ● | ● | ● |
| Degree of protection with sub-base (page 62) | IEC 529 | IP 20 | IP 20 | IP 20 |
| Degree of protection with connector 81 516 082 (page 65) | IEC 529 | IP 65 | IP 65 | IP 65 |
| UL and cUL approval | | MH 15085 | MH 15085 | MH 15085 |

15x15 mm footprint

according to CNOMO E 06-36-120N

Dimensions 81 519 0

81 519 3
81 519 6

Manual override

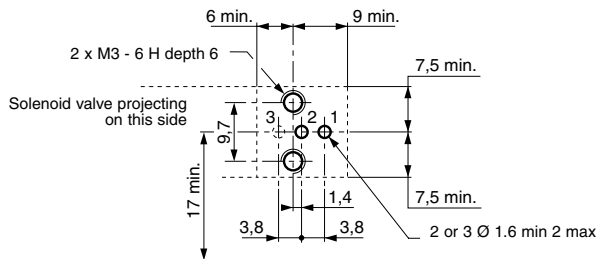

Adjacent side of footprint when valves mounted in bank

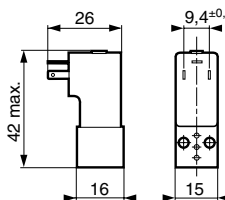

- 1 - Supply
- 2 - Output
- 3 - Exhaust

Miniature solenoid valves for direct current

- Conform to the Low Voltage Directive
- For mounting on sub-base or footprint in accordance with CNOMO recommendation E-06-36-120N



Also available in ATEX version for use in potentially explosive atmospheres in accordance with 94/9/EC Directive

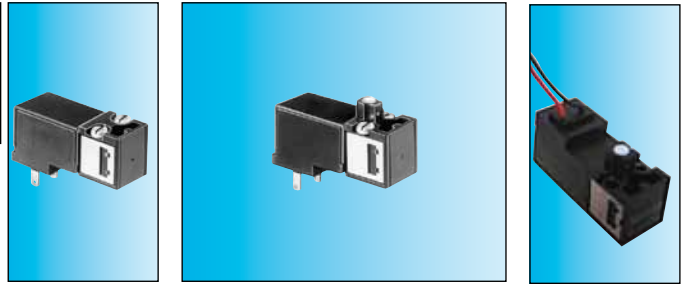

Part numbers (and voltages)

| | Consumption | Voltage | 81 519 032 | 81 519 332 | 81 519 632 | 81 519 340 |
|----------|-------------|-----------------------------|-------------------------|---------------------------------|---------------------------------|---------------------------------|
| Function | 1 W | 24 V $\overline{\text{DC}}$ | 3/2 NC | 3/2 NC | 3/2 NC | 3/2 NF |
| Version | | | Without manual override | With manual override by impulse | With maintained manual override | With maintained manual override |

Characteristics

| | | | | | |
|---|---------|-------------------|-------------------|-------------------|-------------------|
| Operating pressure | bar | 1 → 8 | 1 → 8 | 1 → 8 | 1 → 8 |
| Orifice diameter | mm | 0.8 | 0.8 | 0.8 | 0.8 |
| Flow at 6 bars | NI/min | 25 | 25 | 25 | 25 |
| kV | | 0.3 | 0.3 | 0.3 | 0.3 |
| Switching time | ms | 5 → 15 | 5 → 15 | 5 → 15 | 5 → 15 |
| Mechanical life (operations) | | 5 10 ⁷ | 5 10 ⁷ | 5 10 ⁷ | 5 10 ⁷ |
| Operating temperature | °C | -10 → +50 | -10 → +50 | -10 → +50 | -10 → +50 |
| Compressed air or inert gas - oil-free air filtered to 50 μ | | ● | ● | ● | ● |
| Duty factor | | 100 % ED | 100 % ED | 100 % ED | 100 % ED |
| Insulation class | IEC 85 | F | F | F | F |
| Weight | | 35 | 35 | 35 | 35 |
| Rotatable connector 4 positions in 90° steps | | ● | ● | ● | ● |
| Degree of protection with M12 5-pin connector | IEC 529 | — | — | — | — |
| Degree of protection with connector 81 516 082 | IEC 529 | IP 65 | IP 65 | IP 65 | IP 65 |
| UL and cUL approval | | MH 15085 | MH 15085 | MH 15085 | MH 15085 |

15x15 mm footprint

according to CNOMO E 06-36-120N

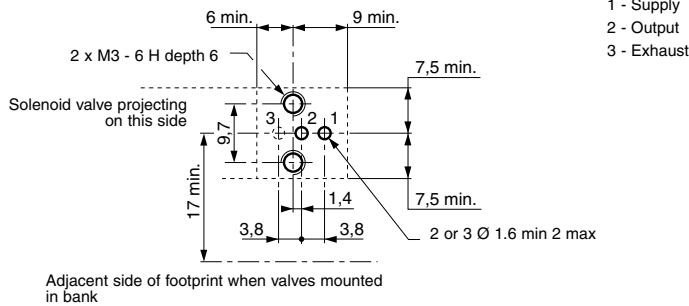

Encombrement 81 519 0

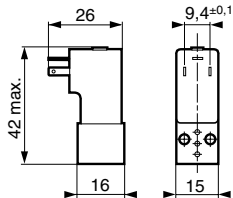

81 519 3 81 519 6

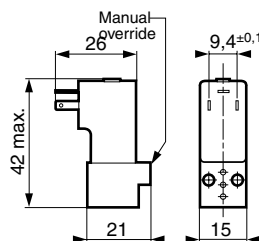

81 519 3

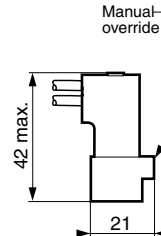

ATEX version products are available in the following catalogues: **Pneumatic products for explosive atmospheres** or on our website www.crouzet.com

Sub-bases for miniature solenoid valves



Also available in **ATEX** version for use in potentially explosive atmospheres in accordance with 94/9/EC Directive

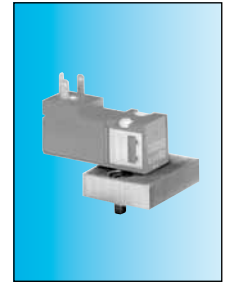
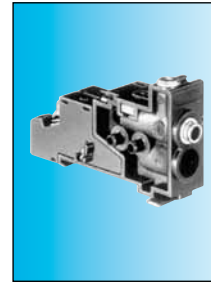
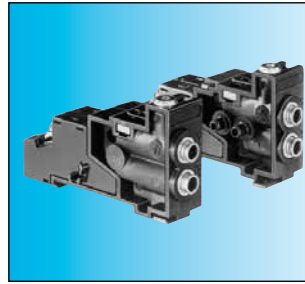

Part numbers

| | | | |
|---|-------------------|-------------------|-------------------|
| Pair of end bases | 81 514 101 | — | — |
| Intermediate sub-base | — | 81 514 161 | — |
| Adaptor sub-base for CNOMO 06-05-80 / NFE 49066 footprint | — | — | 79 453 569 |

Characteristics

| | | | | |
|--|-----------------|----------------|----------------|---------------------|
| Pneumatic indicator on output | — | • | • | — |
| Common supply | — | • | • | — |
| Common exhaust | — | • | • | — |
| Torque capacity | mm ² | 3 | 3 | — |
| Push-in connection for semi-rigid tubing Ø 4 mm (NFE 49100) | mm | • | • | — |
| Mounting | | DIN rail 35 mm | DIN rail 35 mm | 2 screws M4 x 10 |
| UL and cUL approval | g | MH 15085 | MH 15085 | — |
| Weight | | 65 | 30 | 50 |

Connection

Pneumatic

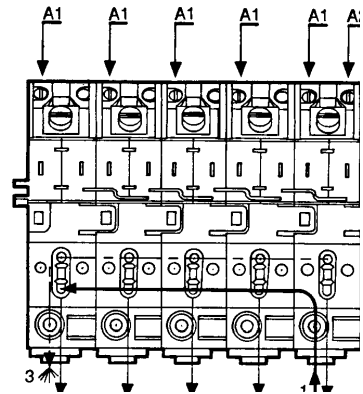

- 1 - Supply
- 2 - Output
- 3 - Exhaust

Electrical

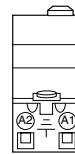

- A1 - Pilot signal
- A2 - Common
- ⊥ - Earth

Dimensions with miniature solenoid valve (page 58)

81 514 101 - 81 514 161

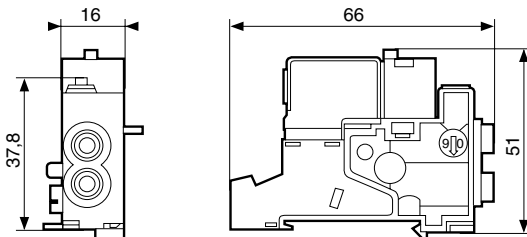

79 453 569

Connector ref 81 516 082
(rotatable in 90° steps)
see page 65

Miniature solenoid valve 81 519 ...
see page 58

CNOMO footprint
E 06-36-120N for mounting
miniature solenoid valve 81 519

Mounting on CNOMO 06-05-80/
NFE 49066 footprint

Fixing on CNOMO 06-05-80/
NFE 49-066 footprint by
2 cap screws M4x10
(NFE 25-127)

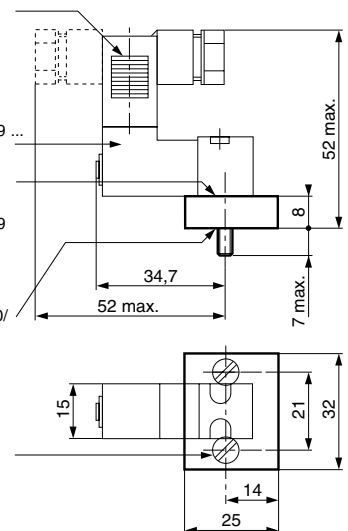

ATEX version products are available in the following catalogues: **Pneumatic products for explosive atmospheres** or on our website www.crouzet.com

Electro-pneumatic miniature control valves

Mounting

Miniature solenoid valves

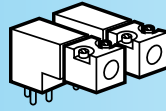

Indicators

- LED seals
- LED

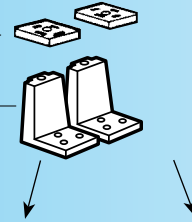

Valve modules

- Poppet
 - 3/2 monostable (17.5 mm)
 - 4/2 monostable (17.5 mm)
- Slide valve
 - 4/2 bistable (35 mm)
 - 4/2 monostable spring-return (35 mm)

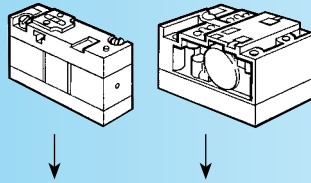

Sub-bases

For miniature solenoid valves

For valve modules

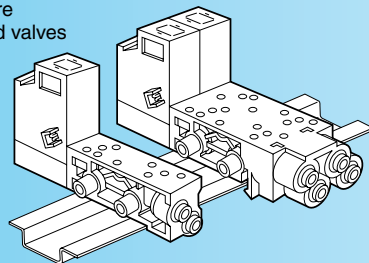

Single

Double

Complete product

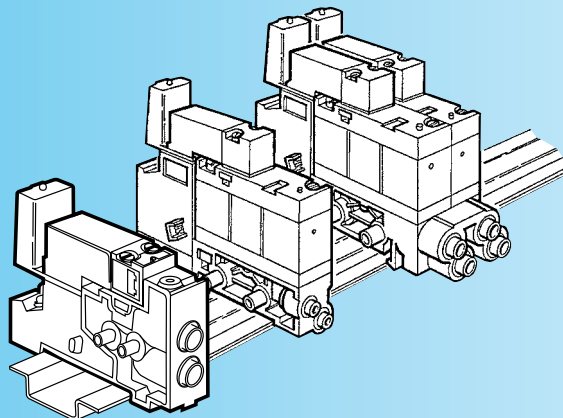

Valve modules

- Monostable, bistable
- 3/2, 4/2



Also available in **ATEX** version for use in potentially explosive atmospheres in accordance with 94/9/EC Directive



81 513 100



81 513 600



81 513 200



81 516 200

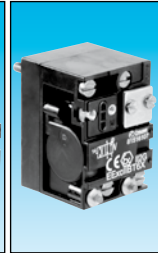

81 516 100

Function

3/2 NC monostable 3/2 NO monostable 4/2 monostable 4/2 bistable 4/2 monostable

Symbol

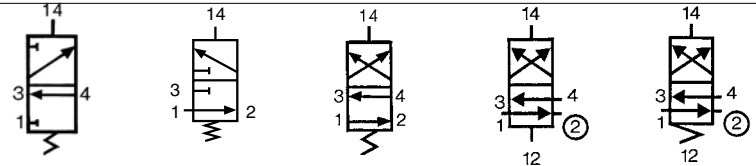

Characteristics

| | | | | | | |
|-----------------------------------|--------------------------------|-----------------------|-----------------------|-----------------------|-----------------|-----------------|
| Width | mm | 17.5 | 17.5 | 17.5 | 35 | 35 |
| Working pressure | bars | 3→8 | 3→8 | 3→8 | 2→8 | 3.5→8 |
| Orifice diameter | mm | 3 | 3 | 3 | 4 | 4 |
| Flow at 6 bars | with Ø 4 mm sub-base (page 63) | 200 | 200 | 200 | 300 | 300 |
| | with Ø 6 mm sub-base (page 63) | Nl/min 300 | 300 | 300 | 400 | 400 |
| Flow Rate | with Ø 4 mm sub-base (page 63) | kV 2.2 | 2.2 | 2.2 | 4 | 4 |
| | with Ø 6 mm sub-base (page 63) | 2.5 | 2.5 | 4 | 5 | 5 |
| Operating temperature | ° C | -10 → +50 | -10 → +50 | -10 → +50 | -10 → +50 | -10 → +50 |
| Switching time for the valve only | ms | 15 | 15 | 15 | 50 | 50 |
| Mechanical life | operations | 1.5 x 10 ⁷ | 1.5 x 10 ⁷ | 1.5 x 10 ⁷ | 10 ⁷ | 10 ⁷ |
| Weight | g | 38 | 38 | 38 | 106 | 106 |

Dimensions

81 513

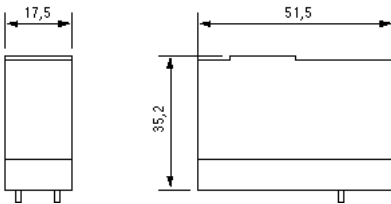

81 516

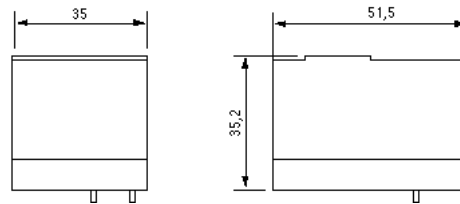

ATEX version products are available in the following catalogues: **Pneumatic products for explosive atmospheres** or on our website www.crouzet.com

Sub-bases and end bases for miniature control valves



Also available in **ATEX** version for use in potentially explosive atmospheres in accordance with 94/9/EC Directive

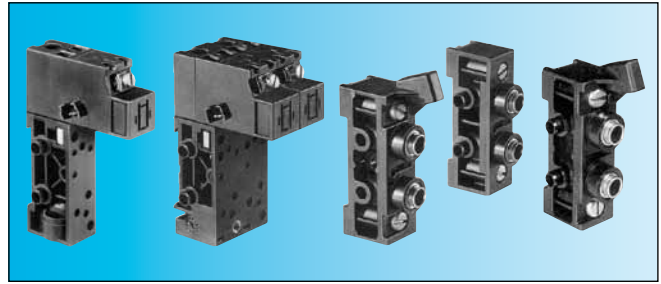

Part numbers

| Mounting | | | Cabinet | Cabinet | Cabinet | Cabinet |
|--|----------------------------|--------|-------------------|-------------------|-------------------|-------------------|
| Version | | | 17.5 mm | 35 mm | — | — |
| Push-in connection for semi-rigid tubing (NFE 49100) | Sub-bases | Ø 4 mm | 81 513 060 | 81 517 101 | — | — |
| | | Ø 6 mm | 81 513 065 | 81 517 201 | — | — |
| | End bases (pair) | Ø 6 mm | — | — | 81 513 011 | — |
| | Intermediate supply module | Ø 6 mm | — | — | — | 81 513 001 |

Characteristics

| | | | | | |
|---------------------|-----|----------------|----------------|----------------|----------------|
| Torque capacity | mm² | 3 | 3 | — | — |
| UL and cUL approval | | MM15085 | MM15085 | — | — |
| Mounting | | DIN rail 35 mm | DIN rail 35 mm | DIN rail 35 mm | DIN rail 35 mm |
| Weight | g | 55 | 110 | 86 | 44 |

Connections Pneumatic



- 2 - Pneumatic output 4/2 (NO)
- 4 - Pneumatic output 3/2 or 4/2 (NC)

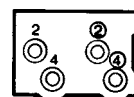

- ② Output at rest (NO)
- ② Output at rest *
- ④ Output at rest *
- ④ Output operating (NC)

81 513 011 - 81 513 001

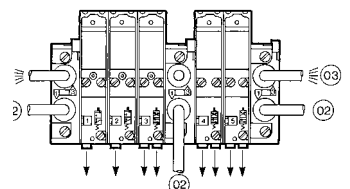

Note :

- Each sub-base can accept
- sub-base 81 513 060-065 : 1 relay 3/2 or 4/2, width 17.5 mm
- sub-base 81 517 101-201 : 1 bistable relay 4/2 (width 35 mm) or 2 relays 3/2 or 4/2 (width 17.5 mm)

② 2 Supply ports

③ 2 Exhaust ports

Integral push-in connections Ø 6 mm

Electrical

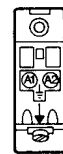

- A1 - Pilot signal
- A2 - Common

Earth

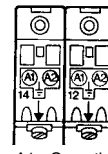

- A1 - Operating control signal (14)
- A2 - Common
- A1 - Rest control signal (12)
- A2 - Common

Earth

Degree of protection : IP20 when assembled.

Dimensions with miniature control valves (page 62) + miniature solenoid valves (page 58) + indicators (page 65)

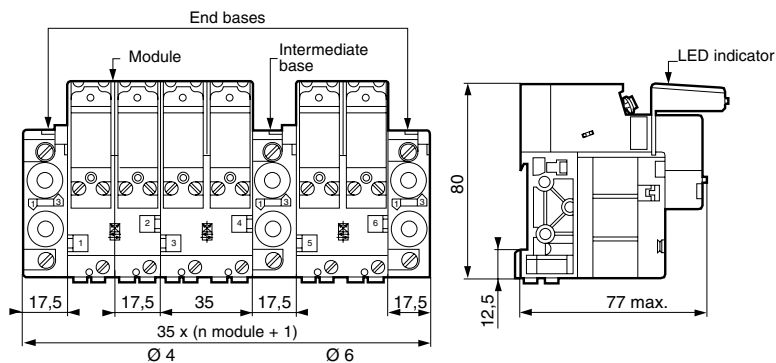

ATEX version products are available in the following catalogues: **Pneumatic products for explosive atmospheres** or on our website www.crouzet.com

Valves and solenoids valves assembled

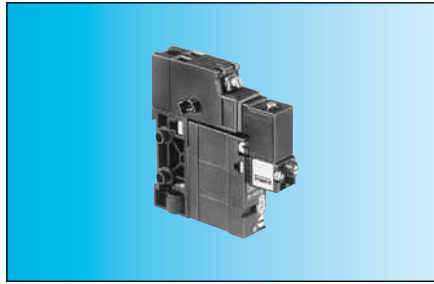

**Contact us for
Other versions**

Part numbers

| | | |
|--|--|--|
| Function | 3/2 NC | 4/2 monostable |
| Sub-base with push-in connection for semi-rigid tubing (NFE 49100) | Ø 4 ext. | Ø 4 ext. |
| Version | Solenoid valve with manual override by impulse | Solenoid valve with manual override by impulse |
| Voltage | 24 VDC (+10% -15%) | 81 513 103 |
| | | 81 513 203 |

Symbol



Characteristics

| | | | |
|--|--------|-----------------------|-----------------------|
| Operating pressure | bar | 3→8 | 3→8 |
| Orifice diameter | mm | 3 | 3 |
| Flow at 6 bars | NL/min | 200 | 200 |
| KV | | 2.2 | 2.2 |
| Operating temperature | °C | -10 → +50 | -10 → +50 |
| Switching time of the assembly | ms | 20 | 20 |
| Mechanical life (operations) at 4 bars | | 1.5 x 10 ⁷ | 1.5 x 10 ⁷ |
| Valve position will be maintained in the event of pressure loss and/or electrical current loss | | — | — |
| Mounting | | DIN rail 35 mm | DIN rail 35 mm |
| Weight | g | 130 | 130 |
| UL and cUL approval | | MH15085 | MH15085 |

Principle of operation

Dimensions

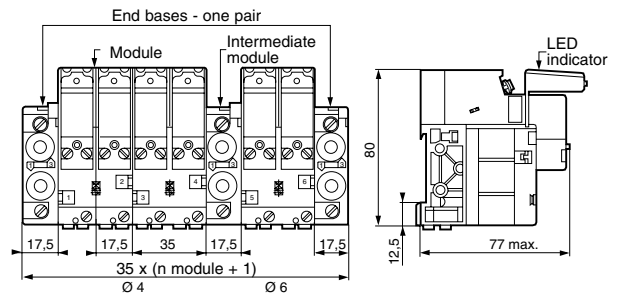
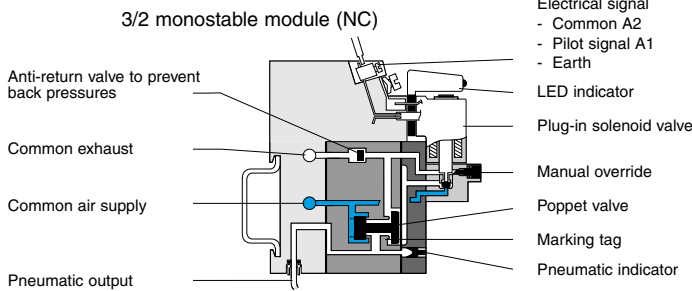

4/2 monostable module

4/2 bistable module

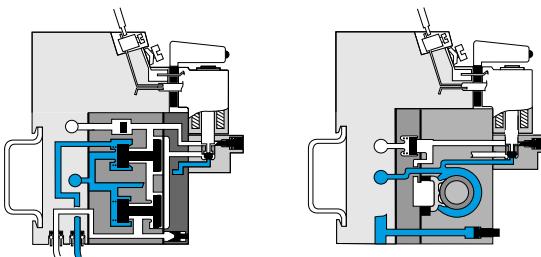

End bases not supplied (page 63)
Intermediate bases not supplied (page 63)
Indicators not supplied (page 65)

5

Solenoid valves

- Reduced "dimensions"
- Mounted on sub-base

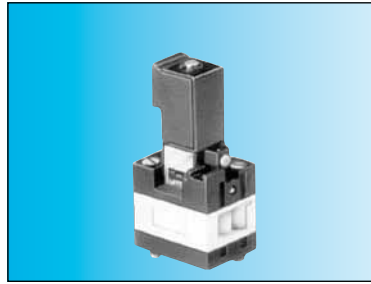

Part numbers and voltages

| | | | |
|-----------------|------------------------------------|-------------------|--|
| Function | | 3/2 NC | |
| Mounting | | On sub-base (54) | |
| Solenoid valves | 24 V (+10% -15%) | 81 519 732 | |
| with | 24 V - 50/60 Hz (+10% -15%) | 81 519 774 | |
| manual | 48V - 50/60 Hz (+10% -15%) | 81 519 775 | |
| override | 110 V - 50/60 Hz (+10% -15%) | 81 519 776 | |
| by impulse | 220 - 230 V - 50/60 Hz (+10% -15%) | 81 519 777 | |

Symbol

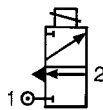

Characteristics

| | | | |
|---|------------|-----------------------|--|
| Operating pressure | bar | 2 → 8 | |
| Orifice diameter | mm | 2.7 | |
| Flow at 6 bars | NI/min | 170 | |
| Rotatable coil 4 positions in 90° steps | | ● | |
| Degree of protection (with connector 81 516 082 not supplied) (see page 65) | IEC 529 | IP 65 | |
| Mechanical life | operations | 1.5 x 10 ⁷ | |
| Consumption | W | 1 | |
| | VA | 2.5 | |
| Operating temperature | °C | -5 → +50 | |
| Weight | g | 70 | |
| UL and cUL approval | | MH15085 | |

Principle of operation

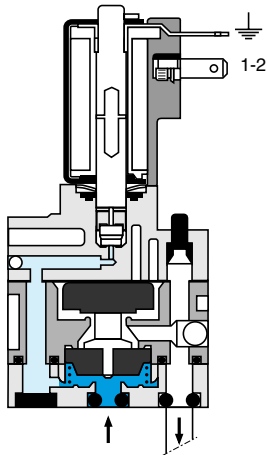

Connections

- Pneumatic { 1 - Supply
2 - Output
- Electrical { 1 - 2 - Pilot signal
⊥ Earth

Electrical connection by connector 81 516 062 (see page 65)

Dimensions

81 519

On separate sub-base

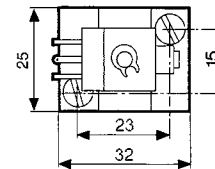
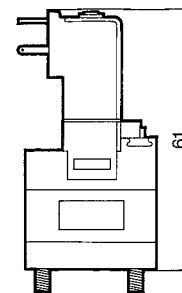

5

► Specific islands "for integrators" (supplied in packs of 20)

► Versions with interfaces 300 NL / mm



Configuration

- 1 - Specify the number and type of interfaces (3 / 2 mono - 4 / 2 mono - 4 / 2 bistable) see page 62.
- 2 - Specify the voltage, the type and method of the control valve connections, see page: 58-59 (Example: 24 V DC with manual switch maintained, exit leads).
- 3 - Please send us your application specifying your requirements and quantities per year, and we will respond as soon as possible.

► Versions with interfaces 30 NL / mm



Configuration

- 1 - Specify the voltage, the type and method of the control valve connections, see page: 58-59 (Example: 24 V DC with manual switch maintained, exit leads).
- 2 - Please send us your application specifying your requirements and quantities per year, and we will respond as soon as possible.

► Develop customised versions to specifications



Crouzet analyses your needs and offers a customised solution.

Mouser Electronics

Authorized Distributor

Click to View Pricing, Inventory, Delivery & Lifecycle Information:

Crouzet:

[81513100](#) [81513200](#) [81513600](#) [81513203](#) [81513052](#) [81519380](#) [81516093](#) [81519348](#) [81513058](#) [81519332](#)
[81513064](#) [81519774](#) [81516200](#) [79453569](#) [81519777](#) [81519048](#) [81519034](#) [81519632](#) [81519678](#) [81516107](#)
[81519335](#) [81519379](#) [81519776](#) [81519331](#) [81517106](#) [81519732](#) [81519132](#) [81516208](#) [81519832](#) [81512401](#)
[81513065](#) [81519035](#) [81514161](#) [81519738](#) [81519635](#) [81519680](#) [81519648](#) [81517201](#) [81513055](#) [81516082](#)
[81513001](#) [81513059](#) [81516081](#) [81517101](#) [81519378](#) [81514101](#) [81513011](#) [81519347](#) [81519037](#) [81516085](#)
[81519032](#) [81513060](#) [81519334](#)