

PLEASE CHECK WWW.MOLEX.COM FOR LATEST PART INFORMATION

Part Number: [0011402222](#)
Status: **Active**
Overview: [Application Tooling](#)
Description: Terminator Die

Documents:

[RoHS Certificate of Compliance \(PDF\)](#)

General

Product Family	Application Tooling
Series	207122
Function	Crimp
Geographic Area	Global
Level of Automation	Semi-Automatic
More Detailed Tech Information	applicationtooling@molex.com
Overview	Application Tooling
Product Name	N/A
Taxonomy	Applicators and Crimp Modules
Tool Type	Terminator Die
UPC	800753906747
Warranty Disclaimer	CAUTION: Molex tooling crimp specifications are valid only when used with Molex terminals and tooling manufactured by Molex and sold by Molex or authorized distributors ("Molex Tooling"). When using tooling other than Molex Tooling with Molex specific connector systems listed in our ATS documents, the Molex tooling qualification does not apply and the responsibility for full qualification of the connector system is that of the customer. Molex accepts no liability for connector performance or tooling support where tooling other than Molex Tooling is used or where Molex Tooling is modified.

Material Info

Engineering Number T8398B

Reference - Drawing Numbers

Application Tooling Documents
T8398B-001, TM-638000029-001,
TM-638000029CN-001, TM-638000029DE-001,
TM-638000029FR-001, TM-638000029IT-001,
TM-638000029JP-001, TM-638000029KR-001,
TM-638000029MY-001, TM-638000029PL-001,
TM-638000029RU-001, TM-638000029SK-001,
TM-638000029SP-001, TM-638000029TH-001,
TM-638000029TW-001, TM-638000029VN-001,
TM-638500090-001, TM-638500090SP-001

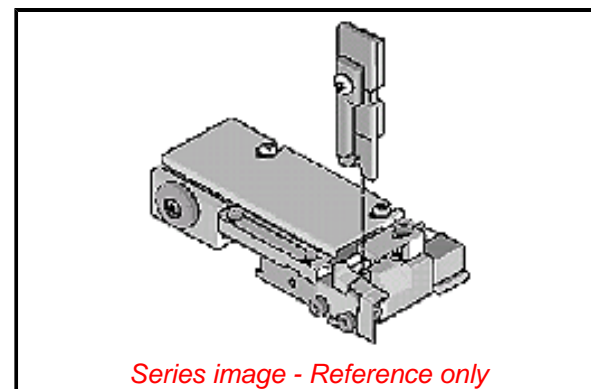

EU ELV

Not Reviewed

EU RoHS

Not Reviewed

REACH SVHC

Not Reviewed

Halogen-Free

Status

Not Reviewed

For more information, please visit [Contact US](#)

China ROHS

Not Reviewed

ELV

Not Reviewed

RoHS Phthalates

Not Reviewed

Search Parts in this Series

[207122 Series](#)

Use With

Molex TM-42 Press [690025001](#) and Base Unit [11193001](#) for the 3BF Press