

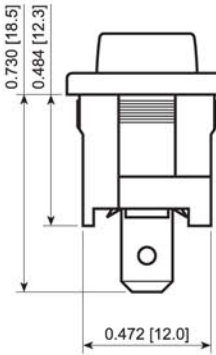

ROCKER

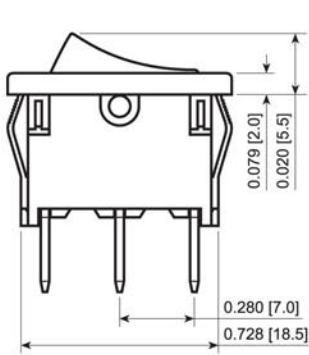

Actuator Options

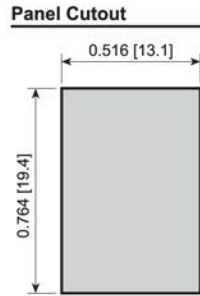
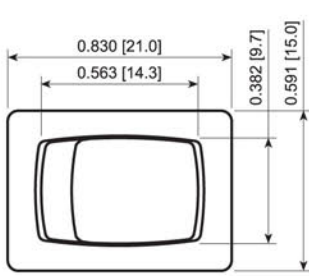
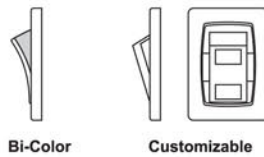

Terminal Options

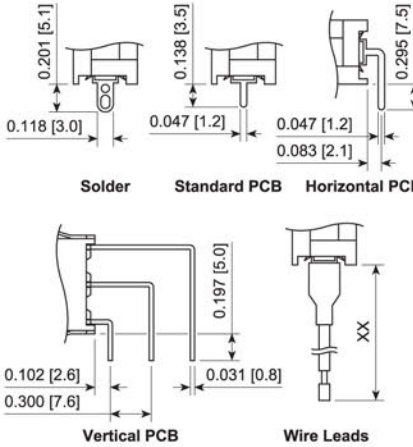

FEATURES:

- High Rating
- Snap in with Multiple terminal options
- Many Functions Available
- PVC Cap for Dust and Water Protection

SPECIFICATIONS:

RATING: RATING OPTION C:
 16A 125VAC [cURus]
 10(6)A 250V- 1E4 T85 [ENEC]
 6(4)A 250V- 5E4 T85 [ENEC]

Rating Option 3:
 11A 125VAC [cURus]
 5.5A 250VAC [cURus]
 4A 250V- 1E4 T55 [ENEC]

Ratings of Illuminated Switches May Vary

TEMPERATURE: -20°C to 55°C Min.
ELECTRICAL LIFE: 10,000 Cycles
CONTACT RESISTANCE: 30mΩ Max.
INSULATION RESISTANCE: 500MΩ Min. at 500VDC
DIELECTRIC STRENGTH: 1,000VAC for 1 Minute
INGRESS PROTECTION: IP54 with PVC Cap

MATERIALS:

BODY: Polyamide 6/6, UL94 V-2
ACTUATOR: Polyamide 6/6, UL94 V-2
 Polycarbonate, UL94 V-2
CONTACTS: Silver Alloy
TERMINALS: Silver Plated Copper

Water Protection Option

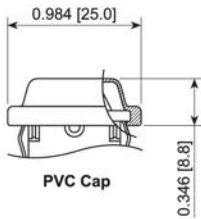

Illumination Options

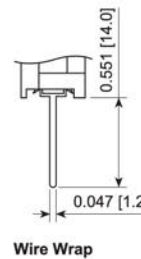
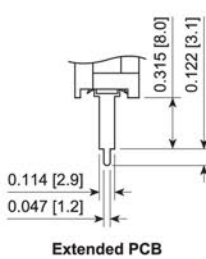
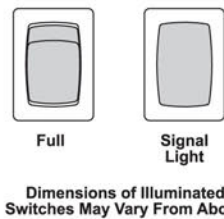

RA111C1A00



RA111C1021-116



RA113C1100 ACC-P01

RA111C1213

Series	Terminal	Function	Rating	Body Color	Actuator Color	Marking Color	Marking Type	Lens Style	Lens Color	Lamp Voltage
RA1 - Curved Actuator	0 - Blank	0 - Signal / Blank	0 - Signal / Blank	1 - Black	0 - Illuminated	0 - None	0 - None	1 - Full / Signal	0 - Clear	3 - 6V
RA1C - Customizable Actuator	1 - 4.8mm Tab (*)	1 - Off-On (*)	3 - 11A 125V	2 - White	1 - Black	1 - Black	1 - I/O Vert.	0 - Clear	1 - Red	4 - 12V
	2 - Solder (*)	3 - On-On	C - 16A 125V	3 - Almond	2 - White	2 - White	2 - ON/OFF/ON Vert.	2 - Amber	3 - Green	6 - 125V
	3 - PCB Pin	4 - Off-(On)		4 - Grey	3 - Almond	8 - Red	3 - ON/OFF Vert.	4 - Blue	4 - Blue	7 - 250V
	H - Horiz. PCB	5 - On-Off-On		9 - Red	4 - Grey		4 - ON/OFF Horiz.	5 - Yellow		
	V - Vert. PCB	A - On-(Off)			5 - Orange		5 - I/O/II Horiz.			
	A14 - Wire Wrap	C - On-Off-(On)			7 - Blue		S - I/O/III Vert.			
	E08 - Ext. PCB	D - (On)-Off-(On)			8 - Green		R - I/O Horiz.			
	Wxx - Wire Leads (xx in Inches)				9 - Red					

Notes:
 Not All Combinations are Available, Please Check with Sales.
 * = Options Available with Illuminated Switches

Custom Colors and Markings Available Upon Request

For Illuminated Switches Only

EXAMPLE PART NUMBERS:

- RA11131100 1P Off-On Black Body/Actuator, No Marking
- RA11131121 1P Off-On Black Body/Actuator, I/O Vert.
- RA111C1100 1P Off-On Black Body/Actuator, No Marking
- RA111C1121 1P Off-On Black Body/Actuator, I/O Vert.
- RA111C1021-116 1P Off-On Red Illum. Actuator, Black Body, I/O Vert.
- RA11331100 1P On-On Black Body/Actuator, No Marking
- RA11531100 1P On-Off-On Black Body/Actuator, No Marking
- RA11531122 1P On-Off-On Black Body/Actuator, ON/OFF/ON Vert.
- RA13131100 1P Off-On Black Body/Actuator, PCB Pins, No Marking
- RA1H331100 1P On-On Black Body/Actuator, Right Angle PCB Pins

Mouser Electronics

Authorized Distributor

Click to View Pricing, Inventory, Delivery & Lifecycle Information:

E-Switch:

[RA1066AFX](#) [RA1066AFH](#) [RA1066AFK](#) [RA1066AFF](#) [RA1066AFC](#) [RA1066ASA](#) [RA1066CSH](#) [RA1066AFA](#)
[RA111C1021-117](#) [RA111C1021-116](#) [RA111C1023-117](#) [RA12001000-137](#) [RA111C1021-136](#)