

KEIL SOFTWARE

Project-Version: MCB11U10-Vers10
 Date / Time: 04.04.2011 02:56:46
 Sheet: 1/3

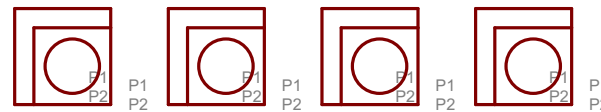
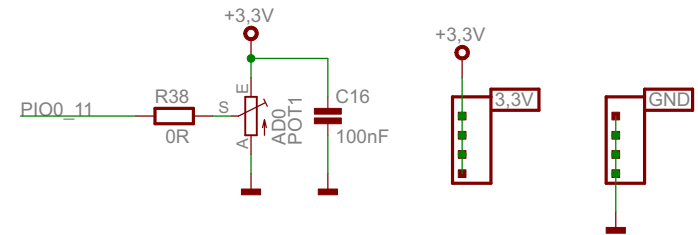
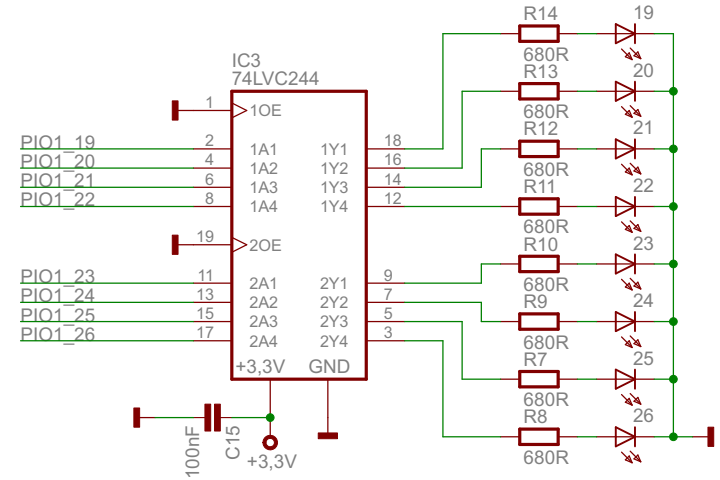
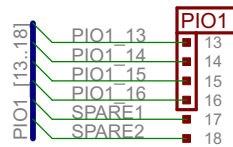
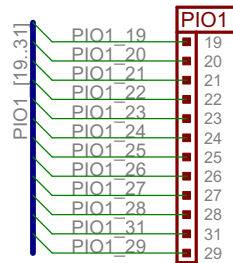
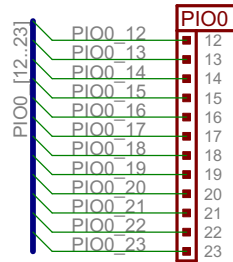
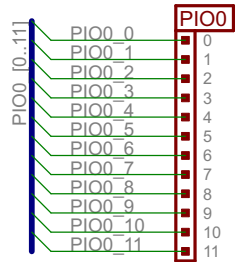

KEIL SOFTWARE	
Project-Version:	MCB11U10-Vers10
Date / Time:	04.04.2011 02:56:46
Sheet:	3/3

Mouser Electronics

Authorized Distributor

Click to View Pricing, Inventory, Delivery & Lifecycle Information:

[NXP:](#)

[OM13018,598](#)