

ISL8225MEVAL3Z

User's Manual: Evaluation Board

Industrial Analog and Power

All information contained in these materials, including products and product specifications, represents information on the product at the time of publication and is subject to change by Renesas Electronics Corp. without notice. Please review the latest information published by Renesas Electronics Corp. through various means, including the Renesas Electronics Corp. website (<http://www.renesas.com>).

ISL8225MEVAL3Z

Evaluation Board

The [ISL8225M](#) is a complete, dual step-down switching mode DC/DC module. The dual outputs can easily be paralleled for single-output, high-current use. It is easy to apply this high-power, current-sharing DC/DC power module to power-hungry datacom, telecom, and FPGA applications. All that is needed in order to have a complete, 30A design ready for use are the ISL8225M, a few passive components, and V_{OUT} setting resistors.

The ease of use virtually eliminates design and manufacturing risks while dramatically improving time to market.

The simplicity of the ISL8225M is its off-the-shelf, unassisted implementation. The module structure allows for higher power density and better efficiency than competing solutions. The current sharing in multiphase operation greatly reduces ripple currents, BOM costs, and complexity.

The ISL8225MEVAL3Z evaluation board enables a single output by paralleling two phases to deliver 30A continuous load current. The ISL8225M supports input voltages from 4.5V to 20V and output voltages from 0.6V to 7.5V. With the single resistor modification, the output voltage can be easily adjusted to different voltages.

Key Features

- Up to 100W output
- Single 30A output
- 4.5V to 20V input range
- 0.6V to 7.5V output range
- 1.5% output voltage accuracy
- Up to 95% conversion efficiency
- Lower output ripple and input ripple due to 180° phase shift

Specifications

This board is configured and optimized for the following operating conditions:

- $V_{IN} = 4.5V$ to 20V, $V_O = 1.2V$
- $I_O = 30A$
- $f_{SW} = 500kHz$
- 180° phase shift between phases

Ordering Information

Part Number	Description
ISL8225MEVAL3Z	30A, Single Output Evaluation Board

Related Literature

For a full list of related documents, visit our website:

- [ISL8225M](#) device page

Related Resources

- Evaluation Board [Video](#)

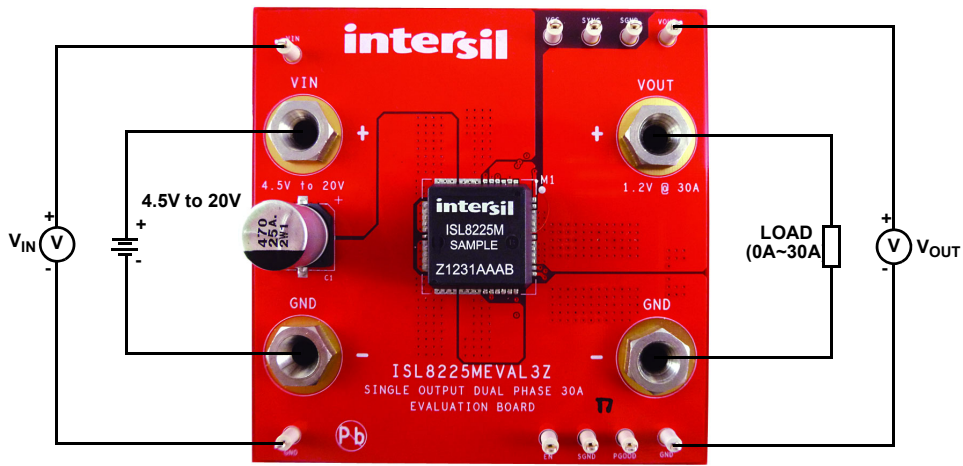

Figure 1. ISL8225MEVAL3Z Board

1. Functional Description

1.1 Recommended Equipment

- 0V to 20V power supply with at least 10A source current capability
- Electronic load capable of sinking current up to 30A
- Digital Multimeters (DMMs)
- 100MHz quad-trace oscilloscope

1.2 High Output Voltage Operation

The evaluation board is designed for output voltage below 5.5V. For output voltage higher than 6V, capacitors with 10V rating must be used for C10 to C14. See the “ISL8225M Design Guide Matrix” table in the [ISL8225M](#) datasheet for selections of output capacitors, input capacitors, and switching frequency. The maximum load capability is 20A for 6.5V output and 14A for 7.5V output.

1.3 Quick Start

The inputs are J1 (VIN) and J2 (GND). The outputs are J3 (VOUT) and J4 (GND). See [Figure 1 on page 3](#) for connections.

1. Connect a power supply capable of sourcing at least 10A to the ISL8225MEVAL3Z's input (VIN J1 and GND J2), with a voltage between 4.5V to 20V. Connect an electronic load or the device to be powered to the board's output (VOUT J3 and GND J4). All connections, especially the low voltage, high current V_{OUT} lines, should be able to carry the desired load current and should be made as short as possible.
2. Turn on the power supply. Measure the output voltage, V_{OUT}, which should be at 1.2V if the board is working properly.
3. The ISL8225MEVAL3Z is manufactured with a default V_{OUT} value of 1.2V. If different output voltages are needed, board resistors can be exchanged to provide the required V_{OUT}. See the table printed on the backside of the evaluation board or [Table 1](#) for R_{VSET} resistor values, which can be used to produce different output voltages.

For 12V V_{IN}, and V_{OUT} more than 1.5V, the switching frequency needs to be adjusted, as shown in [Table 1](#); no frequency adjustments are necessary for V_{OUT} below 1.5V. For 5V V_{IN}, the frequency does not need to be adjusted and the module default frequency can be used at any allowed V_{OUT}. If the output voltage is set to more than 1.8V, the output current needs to be derated to allow for safe operation at elevated ambient temperatures. See the derating curves in the [ISL8225M](#) datasheet.

For V_{IN} < 5.5V, tie VIN directly to VCC for best efficiency. Also, Renesas recommends that the EN/FF voltage is over 1.5V to achieve better stability.

Table 1. Resistance Setting for Different Output Voltages and Operating Frequency (R₃ = 1k)

V _{OUT} (V)	R _{VSET} (Ω)	Frequency (kHz)	R _{FSET} (Ω) (V _{IN} = 12V)
1.0	1500	Default	Default
1.2	Default	Default	Default
1.5	665	Default	Default
2.5	316	650	249k
3.3	221	800	124k
5.0	137	950	82.5k
5.5	121	950	82.5k
6.5	102	750	147k
7.5	86.6	750	147k

2. PCB Layout Guidelines

The evaluation board size is 3 inch x 3 inch. It is a 4-layer board, containing 2-ounce copper on the top and bottom layers and 1-ounce copper on all internal layers. The board can be used as a 30A reference design. See [“Layout” on page 8](#). The board is made up of FR4 material and all components, including the solder attachment, are Pb-free.

2.1 Thermal Considerations and Current Derating

For high current applications, board layout is very critical to make the module operate safely and deliver maximum allowable power. To carry large currents, the board layout needs to be carefully designed to maximize thermal performance. To achieve this, select enough trace width, copper weight, and the proper connectors.

The ISL8225MEVAL3Z is designed for running 30A at 1.2V at room temperature without additional cooling systems needed. However, if the output voltage is increased or the board is operated at elevated temperatures, then the available current is derated. See the derated current curves in the [ISL8225M](#) datasheet to determine the output current available.

For layout of designs using the ISL8225M, the thermal performance can be improved by adhering to the following design tips:

- Use the top and bottom layers to carry the large current. VOUT1, VOUT2, Phase 1, Phase 2, PGND, VIN1, and VIN2 should have large, solid planes. Place enough thermal vias to connect the power planes in different layers under and around the module.
- The Phase 1 and Phase 2 pads are switching nodes that generate switching noise. Keep these pads under the module. For noise-sensitive applications, Renesas recommends keeping the phase pads only on the top and inner layers of the PCB; do not place the phase pads exposed to the outside on the bottom layer of the PCB. To improve the thermal performance, the phase pads can be extended in the inner layer, as shown in Phase 1 and Phase 2 pads on Layer 3 (see [Figure 6](#)) for this 30A evaluation board. Make sure that Layer 2 and Layer 4 have the GND layers cover the extended areas of phase pads at Layer 3 to avoid noise coupling.
- To avoid noise coupling, Renesas recommends adding 470pF capacitors on all the COMP pins of each module for multiple module operations.
- If the ambient temperature is high or the board space is limited, airflow is needed to dissipate more heat from the modules. A heat sink can also be applied to the top side of the module to further improve the thermal performance (heat sink recommendation: Aavid Thermalloy, part number 375424B00034G, www.aavid.com).

2.2 ISL8225MEVAL3Z Board Schematic

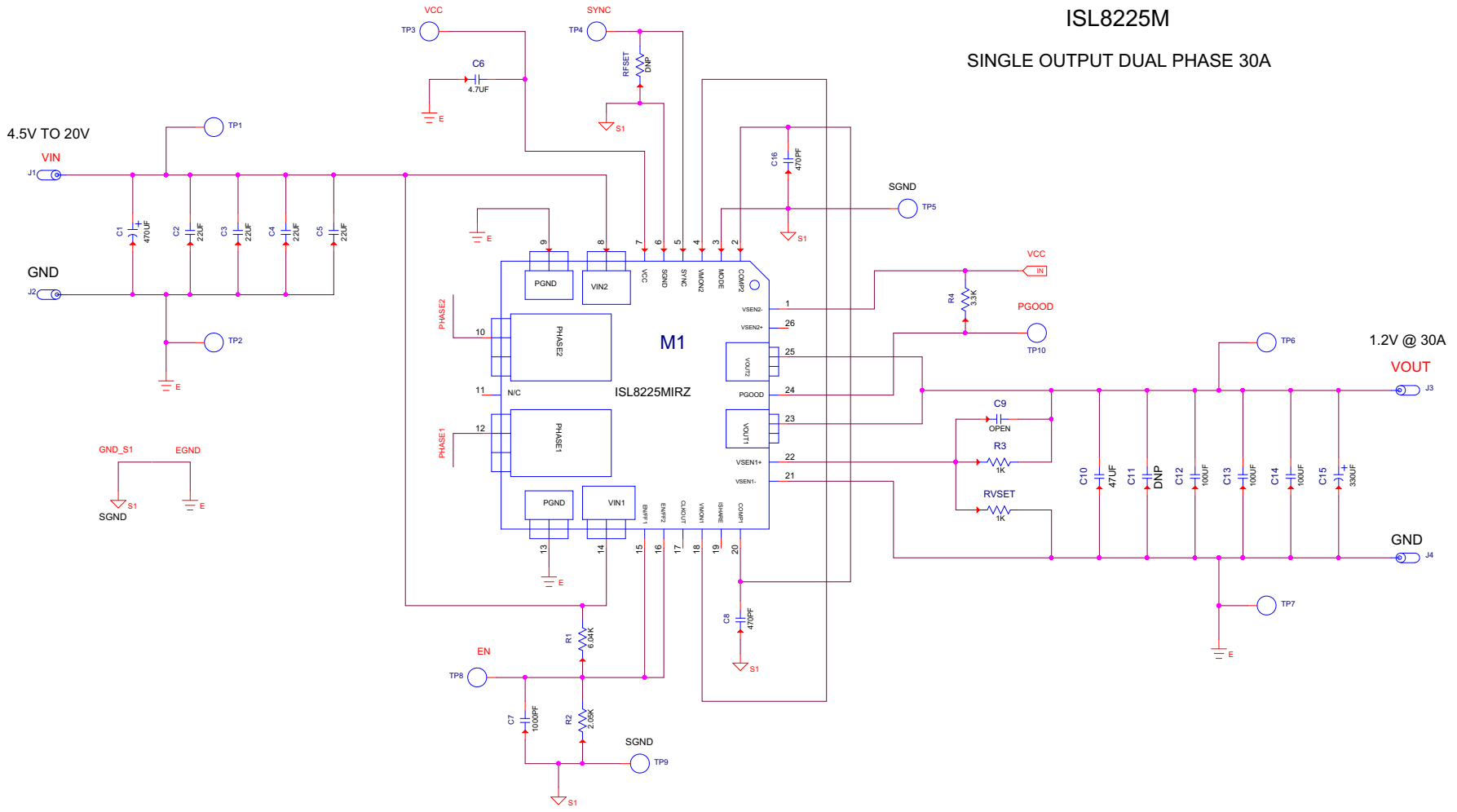

Figure 2. ISL8225MEVAL3Z Board Schematic

2.3 Bill of Materials

Part Number	Ref Des	Qty.	Value	Tol.	Voltage	Power	Package Type	Jedec Type	Manufacturer	Description
108-0740-001	J1-J4	4					CONN	BAN-JACK	Johnson Components	Standard type banana jack
10TPB330M	C15	1	330 μ F	20%	10V		SMD	CAP_7343_149	SANYO-POSCAP	Standard solid electrolytic chip tantalum SMD capacitor
5002	TP1-TP10	10					THOLE	MTP500X	Keystone	Miniature white test point 0.100 pad 0.040 Thole
EEE1EA471P	C1	1	470 μ F	20%	25V		SMD	CAPAE_393X402	Panasonic	Aluminum electrolytic S series type V capacitor (RoHS compliant)
GRM32ER71E226KE15L	C2-C5	4	22 μ F	10%	25V		1210	CAP_1210	Murata	Ceramic chip capacitor
H1045-00102-50V10-T	C7	1	1000pF	10%	50V		603	CAP_0603	Generic	Multilayer capacitor
H1045-00471-50V10	C8, C16	2	470pF	10%	50V		603	CAP_0603	Generic	Multilayer capacitor
H1045-00475-6R3V10-T	C6	1	4.7 μ F	10%	6.3V		603	CAP_0603	Generic	Multilayer capacitor
H1045-OPEN	C9	1	OPEN	5%	OPEN		603	CAP_0603	Generic	Multilayer capacitor
H1046-00476-6R3V20-T	C10	1	47 μ F	20%	6.3V		805	CAP_0805	Generic	Multilayer capacitor
H1065-00107-6R3V20-T	C12-C14	3	100 μ F	20%	6.3V		1206	CAP_1206	Generic	Multilayer capacitor
H1065-OPEN	C11	1	OPEN	5%	OPEN		1206	CAP_1206	Generic	Multilayer capacitor
H2505-DNP-DNP-1	RFSET	1	DNP	1%		DNP	603	RES_0603	Generic	Metal film chip resistor (do not populate)
H2511-02051-1/10W1-T	R2	1	2.05k Ω	1%		1/10W	603	RES_0603	Generic	Thick filmchip resistor
H2511-01001-1/16W1	R3, RVSET	2	1k Ω	1%		1/16W	603	RES_0603	Generic	Thick filmchip resistor
H2511-03301-1/16W5	R4	1	3.3k Ω	5%		1/16W	603	RES_0603	Generic	Thick filmchip resistor
H2511-06041-1/16W1	R1	1	6.04k Ω	1%		1/10W	603	RES_0603	Generic	Thick filmchip resistor
ISL8225MIRZ	M1	1					QFN	QFN26_670X670_ISL8225M	Renesas	Dual 15A DC/DC power module

Note: Resistance accuracy of feedback resistor divider R1/R2 can affect the output accuracy. Please use high accuracy resistance (0.5% or 0.1%) to meet the output accuracy requirement.

2.4 Layout

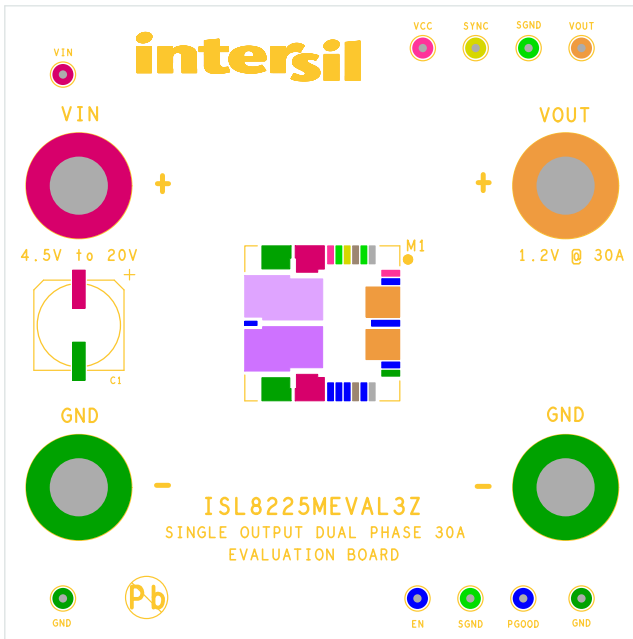

Figure 3. Top Components

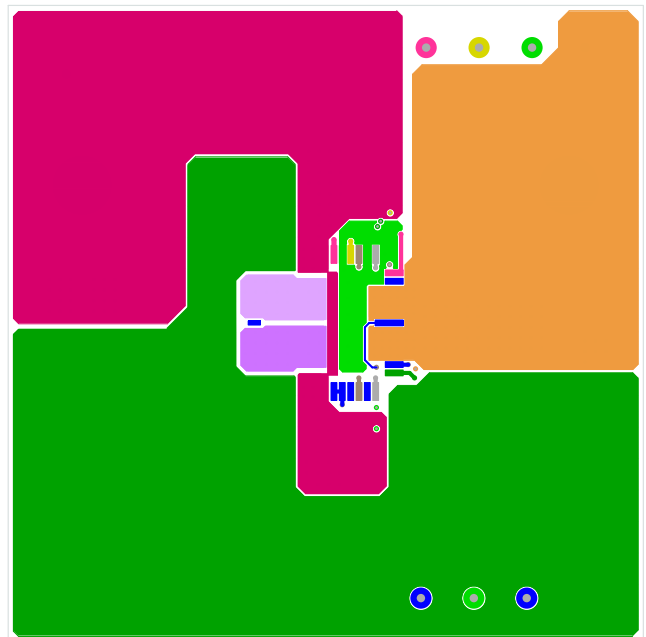

Figure 4. Top Layer

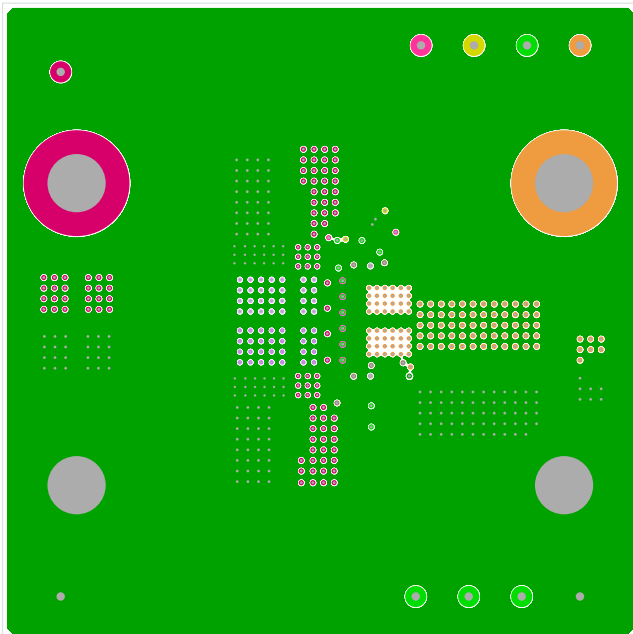

Figure 5. Layer 2

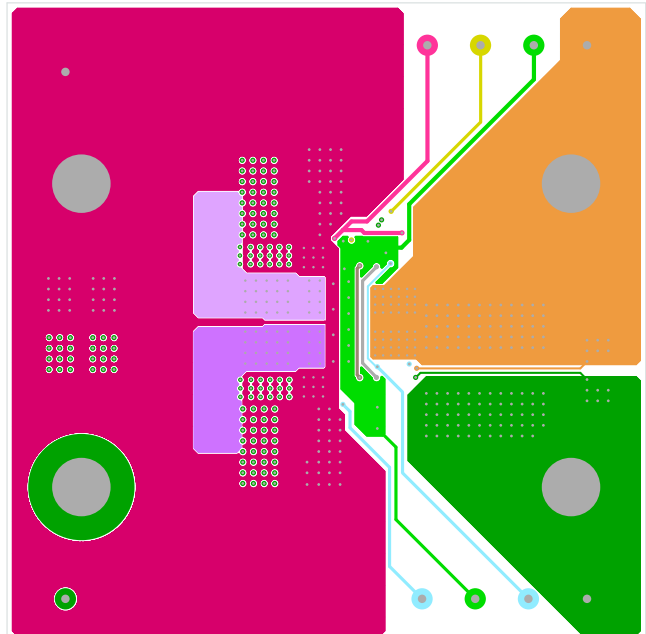

Figure 6. Layer 3

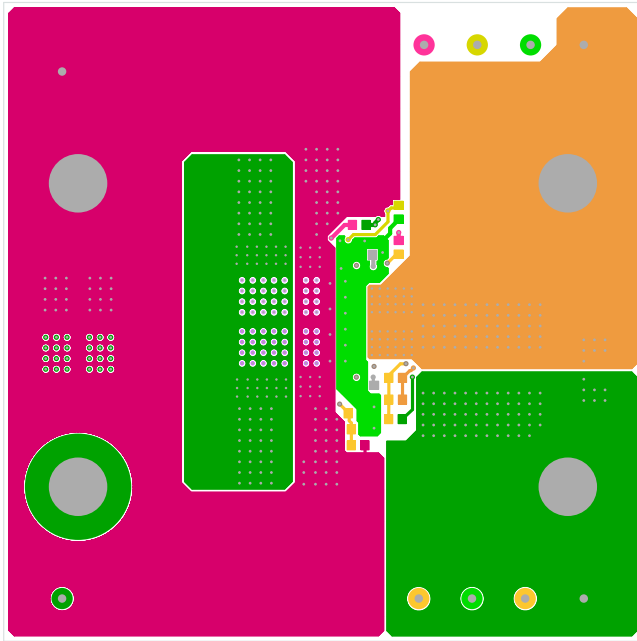

Figure 7. Bottom Layer

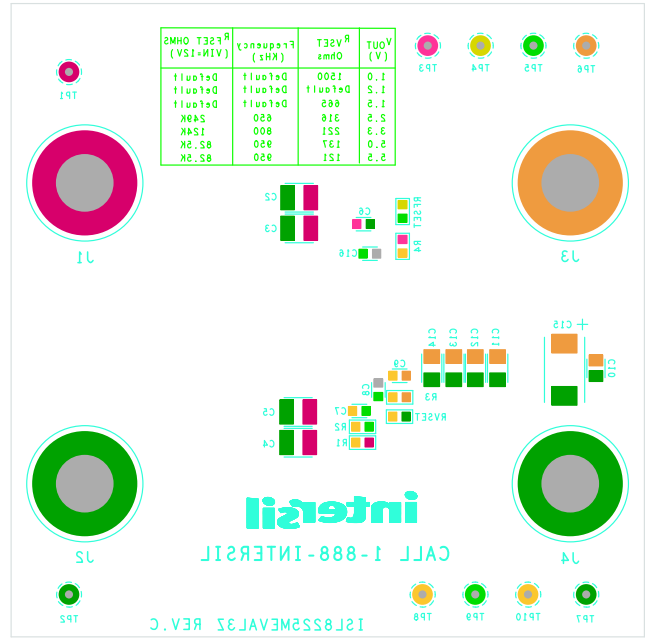

Figure 8. Bottom Components

3. ISL8225MEVAL3Z Efficiency Curves

Test conditions at +25°C and no air flow.

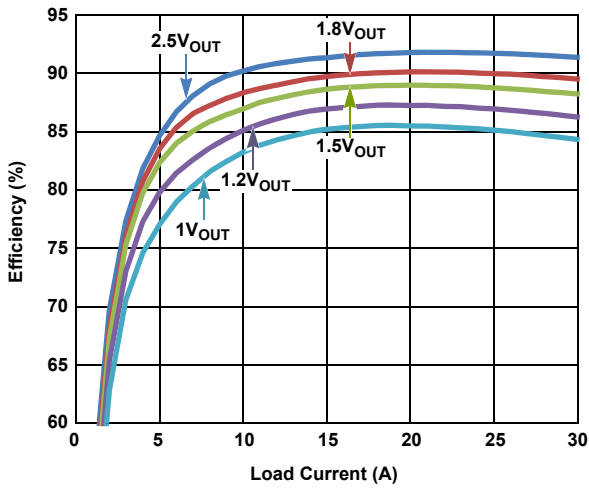

Figure 9. 12V Input

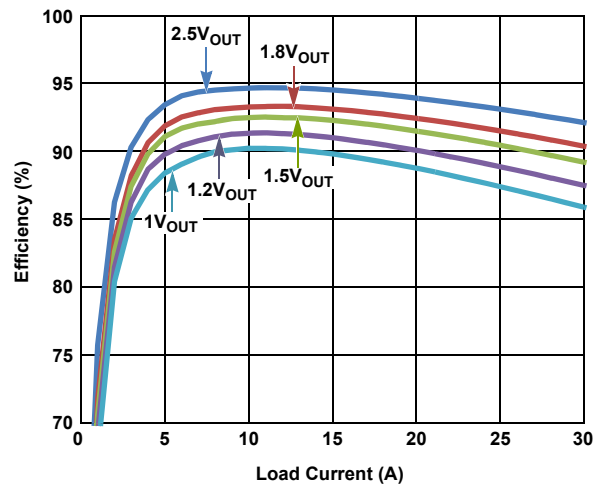

Figure 10. 5V Input

4. Revision History

Rev.	Date	Description
2.00	Jun.10.19	Applied new formatting throughout document. Replaced QR code with link to video on page 1. Added Revision History section.

Notice

1. Descriptions of circuits, software and other related information in this document are provided only to illustrate the operation of semiconductor products and application examples. You are fully responsible for the incorporation or any other use of the circuits, software, and information in the design of your product or system. Renesas Electronics disclaims any and all liability for any losses and damages incurred by you or third parties arising from the use of these circuits, software, or information.
2. Renesas Electronics hereby expressly disclaims any warranties against and liability for infringement or any other claims involving patents, copyrights, or other intellectual property rights of third parties, by or arising from the use of Renesas Electronics products or technical information described in this document, including but not limited to, the product data, drawings, charts, programs, algorithms, and application examples.
3. No license, express, implied or otherwise, is granted hereby under any patents, copyrights or other intellectual property rights of Renesas Electronics or others.
4. You shall not alter, modify, copy, or reverse engineer any Renesas Electronics product, whether in whole or in part. Renesas Electronics disclaims any and all liability for any losses or damages incurred by you or third parties arising from such alteration, modification, copying or reverse engineering.
5. Renesas Electronics products are classified according to the following two quality grades: "Standard" and "High Quality". The intended applications for each Renesas Electronics product depends on the product's quality grade, as indicated below.
 - "Standard": Computers; office equipment; communications equipment; test and measurement equipment; audio and visual equipment; home electronic appliances; machine tools; personal electronic equipment; industrial robots; etc.
 - "High Quality": Transportation equipment (automobiles, trains, ships, etc.); traffic control (traffic lights); large-scale communication equipment; key financial terminal systems; safety control equipment; etc.Unless expressly designated as a high reliability product or a product for harsh environments in a Renesas Electronics data sheet or other Renesas Electronics document, Renesas Electronics products are not intended or authorized for use in products or systems that may pose a direct threat to human life or bodily injury (artificial life support devices or systems; surgical implantations; etc.), or may cause serious property damage (space system; undersea repeaters; nuclear power control systems; aircraft control systems; key plant systems; military equipment; etc.). Renesas Electronics disclaims any and all liability for any damages or losses incurred by you or any third parties arising from the use of any Renesas Electronics product that is inconsistent with any Renesas Electronics data sheet, user's manual or other Renesas Electronics document.
6. When using Renesas Electronics products, refer to the latest product information (data sheets, user's manuals, application notes, "General Notes for Handling and Using Semiconductor Devices" in the reliability handbook, etc.), and ensure that usage conditions are within the ranges specified by Renesas Electronics with respect to maximum ratings, operating power supply voltage range, heat dissipation characteristics, installation, etc. Renesas Electronics disclaims any and all liability for any malfunctions, failure or accident arising out of the use of Renesas Electronics products outside of such specified ranges.
7. Although Renesas Electronics endeavors to improve the quality and reliability of Renesas Electronics products, semiconductor products have specific characteristics, such as the occurrence of failure at a certain rate and malfunctions under certain use conditions. Unless designated as a high reliability product or a product for harsh environments in a Renesas Electronics data sheet or other Renesas Electronics document, Renesas Electronics products are not subject to radiation resistance design. You are responsible for implementing safety measures to guard against the possibility of bodily injury, injury or damage caused by fire, and/or danger to the public in the event of a failure or malfunction of Renesas Electronics products, such as safety design for hardware and software, including but not limited to redundancy, fire control and malfunction prevention, appropriate treatment for aging degradation or any other appropriate measures. Because the evaluation of microcomputer software alone is very difficult and impractical, you are responsible for evaluating the safety of the final products or systems manufactured by you.
8. Please contact a Renesas Electronics sales office for details as to environmental matters such as the environmental compatibility of each Renesas Electronics product. You are responsible for carefully and sufficiently investigating applicable laws and regulations that regulate the inclusion or use of controlled substances, including without limitation, the EU RoHS Directive, and using Renesas Electronics products in compliance with all these applicable laws and regulations. Renesas Electronics disclaims any and all liability for damages or losses occurring as a result of your noncompliance with applicable laws and regulations.
9. Renesas Electronics products and technologies shall not be used for or incorporated into any products or systems whose manufacture, use, or sale is prohibited under any applicable domestic or foreign laws or regulations. You shall comply with any applicable export control laws and regulations promulgated and administered by the governments of any countries asserting jurisdiction over the parties or transactions.
10. It is the responsibility of the buyer or distributor of Renesas Electronics products, or any other party who distributes, disposes of, or otherwise sells or transfers the product to a third party, to notify such third party in advance of the contents and conditions set forth in this document.
11. This document shall not be reprinted, reproduced or duplicated in any form, in whole or in part, without prior written consent of Renesas Electronics.
12. Please contact a Renesas Electronics sales office if you have any questions regarding the information contained in this document or Renesas Electronics products.

(Note1) "Renesas Electronics" as used in this document means Renesas Electronics Corporation and also includes its directly or indirectly controlled subsidiaries.

(Note2) "Renesas Electronics product(s)" means any product developed or manufactured by or for Renesas Electronics.

(Rev.4.0-1 November 2017)

Corporate Headquarters

TOYOSU FORESIA, 3-2-24 Toyosu,
Koto-ku, Tokyo 135-0061, Japan
www.renesas.com

Contact Information

For further information on a product, technology, the most up-to-date version of a document, or your nearest sales office, please visit:
www.renesas.com/contact/

Trademarks

Renesas and the Renesas logo are trademarks of Renesas Electronics Corporation. All trademarks and registered trademarks are the property of their respective owners.

ISL8225MEVAL3Z