

Using the UCC28610EVM-474

User's Guide



Literature Number: SLUU383C
November 2009–Revised June 2011

UCC28610EVM-474 25-W Universal Off-Line Flyback Converter

1 Introduction

The UCC28610EVM-474 evaluation module is a 25-W off-line Discontinuous Mode (DCM) flyback converter providing 12 V at 2.1-A maximum load current, operating from a universal AC input. The module is controlled with the UCC28610 Green-Mode Flyback Controller which uses a cascoded architecture that allows fully integrated current control without an external sense resistor. The converter maintains discontinuous mode operation over the entire operating range. This innovative approach results in efficiency, reliability, and system cost improvements over a conventional flyback.

2 Description

This evaluation module uses the UCC28610 Green-Mode Flyback Controller ([TI Literature Number SLUS888](#)) in a 25-W DCM flyback converter that exceeds Energy Star™ EPS version 2.0 for efficiency during active load and no-load power consumption. The input accepts a voltage range of 85 V_{AC} to 265 V_{AC}. The output provides a regulated output voltage of 12 V_{DC} at a load current of up to 2.1 A. The converter will transition through three operating modes: green mode (GM), amplitude modulation (AM), and frequency modulation (FM), depending upon the power level and FB current. In FM mode, the on-time is fixed, resulting in a fixed peak primary current at each cycle, and the switching frequency is increased with increasing load. In AM mode, the switching frequency is fixed at 30 kHz and the peak primary current is modulated with the on-time as with any typical PWM controller. Green mode operation at light load consists of burst packets of 30-kHz pulses with a fixed on-time and peak primary currents of 33% of the maximum programmed level. Low system parts count and built in advanced protection features result in a cost-effective solution that meets stringent world-wide energy efficiency requirements.

This user's guide provides the schematic, component list, assembly drawing, art work, and test set up necessary to evaluate the UCC28610 in a typical off-line converter application.

2.1 Applications

The UCC28610 is suited for use in isolated off-line systems requiring high efficiency and advanced fault protection features including:

- AC/DC Adaptors that have a Peak Power Output of 12 W to 65 W
- Housekeeping and Auxiliary Power Supplies
- Off-line Battery Chargers
- Consumer Electronics (DVD players, set-top boxes, gaming, printers, etc.)

2.2 Features

The UCC28610EVM-474 features include:

- Isolated 25 W, 12-V output
- Universal Off-Line Input Voltage Range
- Exceeds Energy Star™ EPS Version 2.0 Requirements for Active Load Efficiency and No-Load Power Consumption
- Cascoded Configuration Allows Fully Integrated Current Control Without an External Sense Resistor
- Multiple Operating Modes for Optimum Efficiency Over entire Operating Range
- Over Current Protection to Limit RMS Input and Output Current
- Timed overload with Shutdown/Retry Response
- Opto-Less Output Overload Protection

CAUTION

High voltage levels are present on the evaluation module whenever it is energized. Proper precautions must be taken when working with the EVM. The large bulk capacitor, C9, and the output capacitors, C15 and C16, must be completely discharged before the EVM can be handled. Serious injury can occur if proper safety precautions are not followed.

3 Electrical Performance Specifications

Table 1. UCC28610EVM-474 Electrical Performance Specifications

PARAMETER		CONDITIONS	MIN	NOM	MAX	UNITS
INPUT CHARACTERISTICS						
V_{IN}	Input voltage		85		265	VRMS
I_{IN}	Input current	$V_{IN} = 115 V_{RMS}, I_{OUT} = \max$		0.3		A
		$V_{IN} = 115 V_{RMS}, I_{OUT} = 0 A$		0.03		A
V_{UVLO}	Brown out	$I_{OUT} = \max$		72		V
OUTPUT CHARACTERISTICS						
V_{OUT}	Output voltage	$V_{IN} = \min \text{ to } \max, I_{OUT} = \min \text{ to } \max$	10.8	12	13.2	V
V_{ripple}	Output voltage ripple	$V_{IN} = 115 V_{RMS}, I_{OUT} = \max$		80	120	mVpp
I_{OUT}	Output current	$V_{IN} = \min \text{ to } \max$	0		2.1	A
I_{OCP}	Output over current inception point	$V_{IN} = \max$		3		A
V_{OVP}	Output OVP	$I_{OUT} = \min \text{ to } \max$			16	V
	Transient response voltage over shoot	$I_{OUT} = \min \text{ to } \max$		500		mV
SYSTEM CHARACTERISTICS						
f_{SW}	Switching frequency		26.3		140.4	kHz
η_{PEAK}	Peak efficiency	$V_{IN} = 115 V_{RMS}, I_{OUT} = 1.05 A$		85.7		%
	No load power consumption	$V_{IN} = 115 V_{RMS}$		67		mW
		$V_{IN} = 230 V_{RMS}$		107		
	Operating temperature range	$V_{IN} = \min \text{ to } \max, I_{OUT} = \min \text{ to } \max$		25		°C
MECHANICAL CHARACTERISTICS						
Width	Dimensions			2.3		inches
Length				3.5		
Height		Component height			1	

4 Schematic/Revision Code Placement

NOTE: For revision A versions of the evaluation module, please refer to Appendix A of this user's guide for the schematic, list of materials and board layout. The EVM revision code can be found on the lower right corner of the top side of the board, as shown in [Figure 1](#).

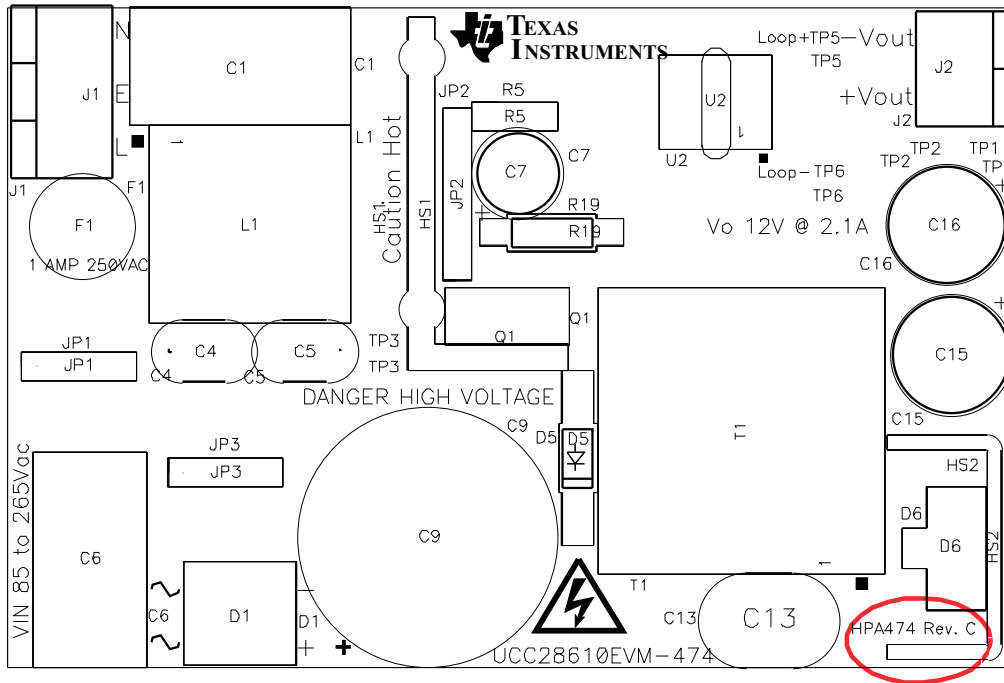

Figure 1. Placement of Revision Code for the Evaluation Module.

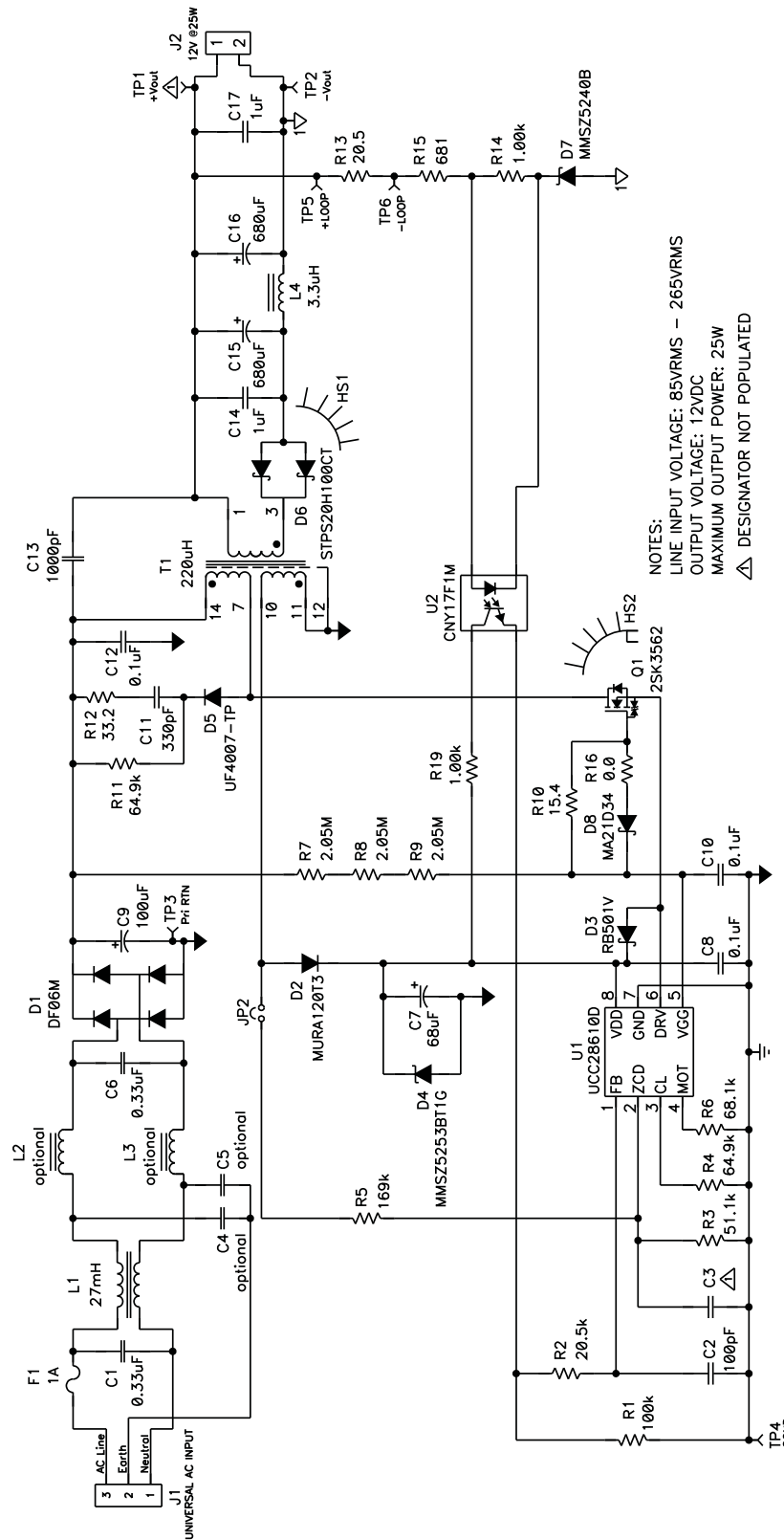

Figure 2. UCC28610EVM-474 Schematic

4.1 Circuit Description

A brief description of the circuit elements follows:

- Diode bridge D1, input capacitor C9, transformer (a.k.a. flyback inductor) T1, HV MOSFET Q1, UCC28610 controller U1, Schottky rectifier D6, Output capacitors C15 and C16 form the power stage of the converter. Note that the UCC28610 U1 is part of the power stage. This is because the DRV and GND pins carry the full peak primary side current of the converter.
- Capacitors C12, C14, and C17 filter the high frequency noise directly across the electrolytic input and output capacitors.
- The input EMI filter is made up of X2 capacitors, C1 and C6, and common mode inductor L1 and Y2 capacitors, C4 and C5. Excessive surge current protection is provided by a slow blow fuse, F1.
- Resistor R11, capacitor C11, and diode D5 make up the primary side voltage clamp for the HV MOSFET. The clamp prevents the drain voltage on Q1 from exceeding its maximum rating. The integrated snubber, composed of R12 and C11, reduces the ringing on the primary side windings that might inadvertently trigger the zero current detection circuit in the device.
- Resistors R7, R8, and R9 supply start up bias current to the VGG shunt regulator. Schottky diode D3 is required to provide initial start up to VDD from VGG at start up.
- Operating bias to the controller is provided by the auxiliary winding on T1, diode D2, and bulk capacitor C7. The zener diode, D4, maintains the bias voltage on VDD below the absolute maximum rating at full load.
- Gate drive circuitry is composed of gate drive resistor R10, used for damping oscillations during turn on. Resistor R16 and diode D8 are required to provide a current path at turn off because the gate is shorted to the source of the HV MOSFET during each switching cycle. For circuits that experience high ringing on VGG at turn off, R16 can be replaced with a ferrite bead.
- Capacitors C8 and C10 are decoupling capacitors which should always be good quality low ESR/ESL type capacitors placed as close to the device pins as possible and returned directly to the device ground reference.
- C13 filters the common mode noise between the primary and secondary sides.
- Inductor L2, with capacitor C16, reduces the output voltage ripple.
- Resistors R5 and R3 program the over voltage threshold. Capacitor C3 can be used to add a small delay to ZCD, to align the turn on time of the primary switch with the resonant valley of the primary winding.
- Resistor R6 programs the maximum on time of the HV MOSFET.
- Resistor R4 sets the maximum value for the peak primary current.
- Resistor R2 and capacitor C2 provide a filter for the FB signal while resistor R1 ensures that the optocoupler emitter current can go to 0A. Resistor R19 provides a non-intrusive point to monitor the FB by measuring the voltage drop across R19.
- The simple output voltage feedback loop is composed of zener diode D7, resistors R14 and R15, and the optocoupler U2. Using an opto with a low CTR provides better noise immunity. Resistor R13 is used as an injection point for small signal frequency response testing.

5 EVM Test Set Up

Figure 2 shows the equipment set up when measuring the input power consumption during no load. Note the addition of the 10- Ω shunt resistor in Figure 3. During the no-load test, the power analyzer should be set for long averaging in order to include several cycles of operation and an appropriate current scale factor for using the external shunt must be used. Figure 3 shows the basic test set up recommended to evaluate the UCC28610EVM-474 with a load.

WARNING

High voltages that may cause injury exist on this evaluation module (EVM). Please ensure all safety procedures are followed when working on this EVM. Never leave a powered EVM unattended.

5.1 Test Equipment

See Figure 3 and Figure 4 for recommended test set ups.

- **AC Input Source:** The input source shall be an isolated variable AC source capable of supplying between 85 V_{RMS} and 265 V_{RMS} at no less than 30 W and connected as shown in Figure 3 and Figure 4. For accurate efficiency calculations, a power meter should be inserted between the neutral line of the AC source and the Neutral terminal of the EVM. For highest accuracy, connect the voltage terminals of the power meter directly across the Line and Neutral terminals of the EVM.
- **Load:** For the output load, a programmable electronic load set to constant current mode and capable of sinking 0 to 3 A_{DC} at 12 V_{DC} shall be used. For highest accuracy, V_{OUT} can be monitored by connecting a DC voltmeter, DMM V_1 , directly across the +Vout and -Vout terminals as shown in Figure 3 and Figure 4. A DC current meter, DMM A_1 , should be placed in series with the electronic load for accurate output current measurements.
- **Power Meter:** The power analyzer shall be capable of measuring low input current, typically less than 10 mA, and a long averaging mode if low power standby mode input power measurements are to be taken. An example of such an analyzer is the Voltech PM100 Single Phase Power Analyzer. To measure the intermittent bursts of current and power drawn from the line during no-load operation, an external 10- Ω shunt, with a current scale factor of 10 A/V, was used at a high sample rate over an extended period of time in order to display the averaged results (refer to Figure 3).
- **Multimeters:** Two digital multimeters are used to measure the regulated output voltage (DMM V_1) and load current (DMM A_1).
- **Oscilloscope:** A digital or analog oscilloscope with a 500-MHz scope probe is recommended.
- **Fan:** Forced air cooling is not required.
- **Recommended Wire Gauge:** a minimum of AWG18 wire is recommended. The wire connections between the AC source and the EVM, and the wire connections between the EVM and the load should be less than two feet long.

5.2 Recommended Test Set Up for Operation Without a Load

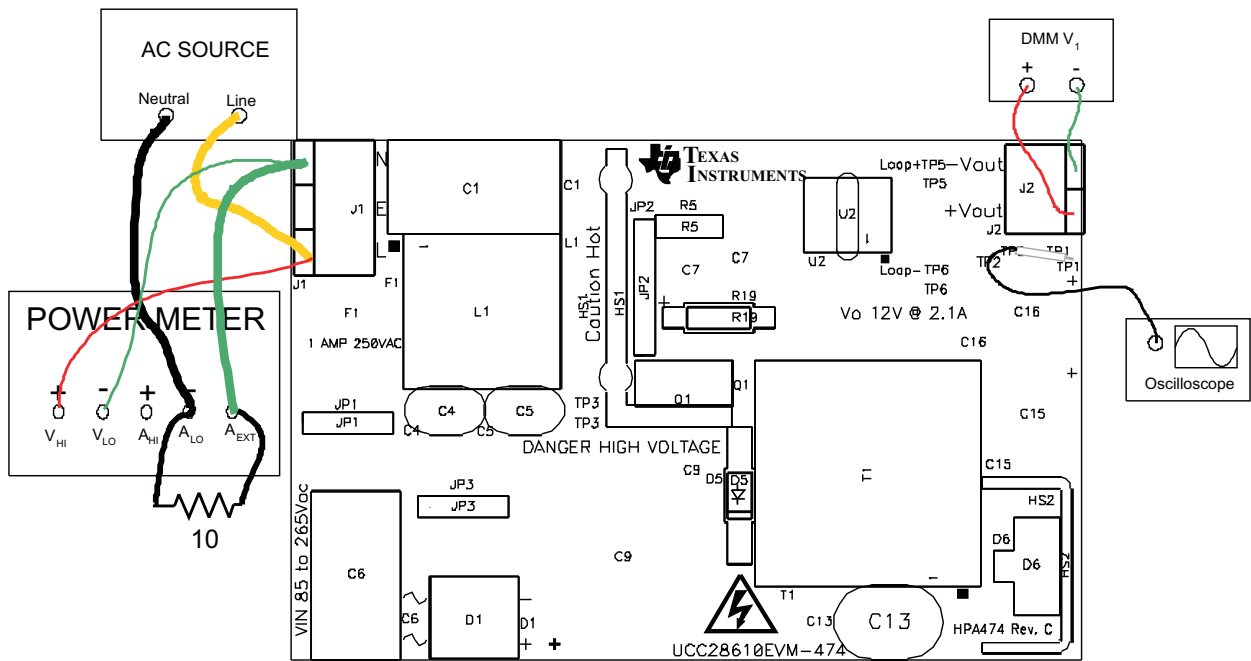

Figure 3. UCC28610EVM-474 Recommended Test Set Up Without a Load

5.3 Recommended Test Set Up for Operation With a Load

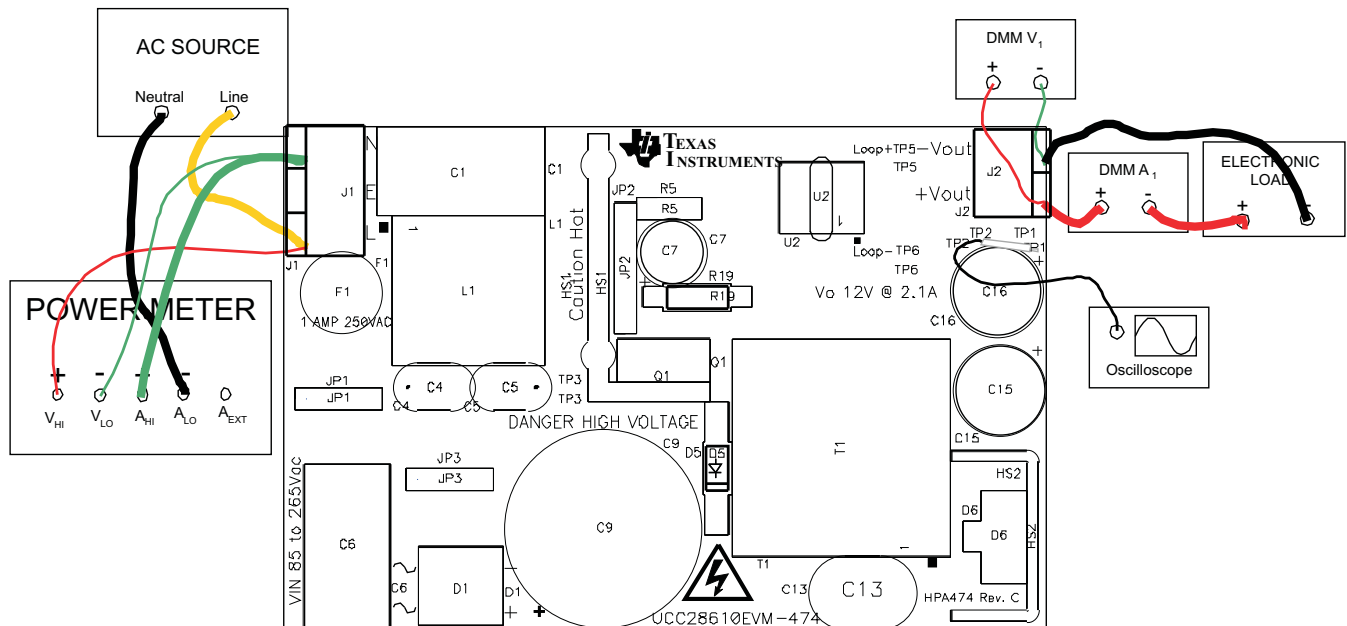

Figure 4. UCC28610EVM-474 Recommended Test Set Up With a Load

5.4 List of Test Points

Table 2. Test Point Functional Description

TEST POINT	NAME	DESCRIPTION
TP1	+Vout	Output voltage of EVM; this designator is not populated with a pin in order to facilitate tip and barrel output ripple voltage measurements.
TP2	-Vout	Return of the output of the EVM, secondary side GND reference.
TP3	Pwr RTN	Primary side power ground
TP4	QGND	Primary side signal ground
TP5	+LOOP	Loop injection point, EVM output
TP6	-LOOP	Loop injection point
J1-1	Neutral	Neutral input from the AC source
J1-2	Earth	Earth reference from the AC source
J1-3	AC Line	Line input from AC source
J2-1	+Vout	Positive output terminal of the EVM to the load
J2-2	-Vout	Return connection of the EVM output to the load

6 Test Procedure

All tests should use the set up as described in [Section 5](#) of this user's guide. The following test procedure is recommended primarily for power up and shutting down the evaluation module. Never leave a powered EVM unattended for any length of time.

6.1 Applying Power to the EVM

1. Set up the EVM as shown in [Section 5](#) of this user's guide
 - (a) If no-load input power measurements are to be made, set the power analyzer to long averaging and external shunt mode. Insert a shunt, such as a 10- Ω resistor as shown in [Figure 3](#), in series with the Neutral terminal of the EVM. Set the appropriate current scale on the power analyzer.
 - (b) For operation with a load, as shown in [Figure 4](#), set the electronic load to constant current mode to sink 0 A.
2. Prior to turning on the AC source, set the voltage to between 85 V_{AC} and 265 V_{AC}.
3. Turn on the AC source.
4. Monitor the output voltage on DMM V₁.
5. Monitor the output current on DMM A₁.
6. The EVM is now ready for testing.

6.2 No-Load Power Consumption

1. Use the test set up shown in [Figure 3](#).
 - (a) Set the power analyzer to external shunt mode.
 - (b) Set the appropriate current scale factor for using an external shunt on the power analyzer. A 10- Ω shunt scales at 10,000 mV/A for the PM100 Voltech.
 - (c) Set the power analyzer long averaging time to include several cycles of operation. The PM100 Voltech should be set to a long averaging time of 10 or more for accurate burst mode measurements.
2. Apply power to the EVM per [Section 6.1](#).
3. Monitor the input power on the power analyzer while varying the input voltage.
4. Make sure the input power is off and the bulk capacitor and output capacitors are completely discharged before handling the EVM.

6.3 Output Voltage Regulation and Efficiency

1. For load regulation:
 - (a) Use the test set up shown in [Figure 4](#).
 - (i) Be sure to remove the external shunt from the power analyzer and set the analyzer to normal mode (not long averaging).
 - (b) Set the AC source to a constant voltage between 85 V_{AC} and 265 V_{AC}.
 - (c) Apply power to the EVM per [Section 6.1](#).
 - (d) Vary the load current from 0 A up to 2.1 A, as measured on DMM A₁.
 - (e) Observe that the output voltage on DMM V₁ remains within 10% of 12 V_{DC}.
2. For line regulation:
 - (a) Set the load to sink 2.1 A.
 - (b) Vary the AC source from 85 V_{AC} to 265 V_{AC}.
 - (c) Observe that the output voltage on DMM V₁ remains within 10% of 12 V_{DC}.
3. Make sure the input power is off and the bulk capacitor and output capacitors are completely discharged before handling the EVM.

6.4 Output Voltage Ripple

1. Expose the ground barrel of the scope probe. Insert the tip of the probe into the plated via located on the +Vout pad of the EVM (TP1) and lean the probe so that the exposed ground barrel is resting on the test point on the -Vout pad of the EVM (TP2) for a tip and barrel measurement as shown in the example depicted in [Figure 5](#).
2. Apply power to the EVM per [Section 6.1](#).
3. Monitor the output voltage ripple on the oscilloscope.

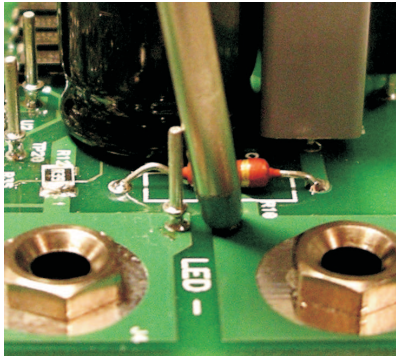

Figure 5. Typical Example of Tip and Barrel Measurement Technique

NOTE: This photo was not taken on the UCC28610EVM specifically but serves as a visual aid to perform the test measurement.

6.5 Equipment Shutdown

1. Ensure the load is at maximum; this will quickly discharge the output capacitors.
2. Turn off the AC source.

7 Performance Data and Typical Characteristic Curves

Figure 6 through Figure 23 present typical performance curves for the UCC28610EVM-474.

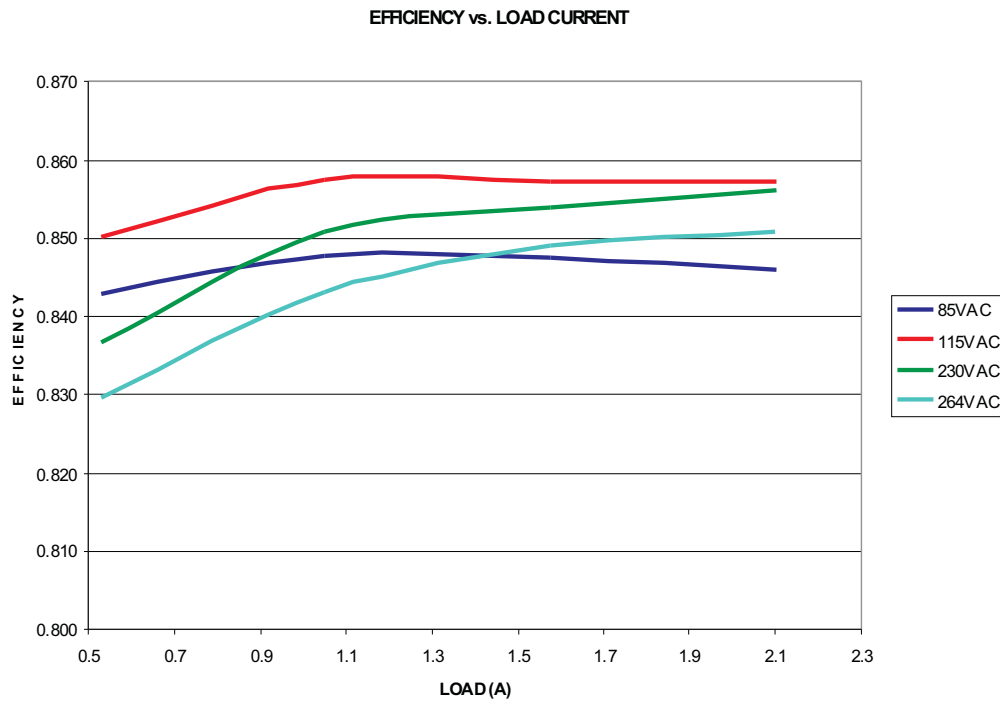

Figure 6. Efficiency as a Function of Load Current and Input Voltage

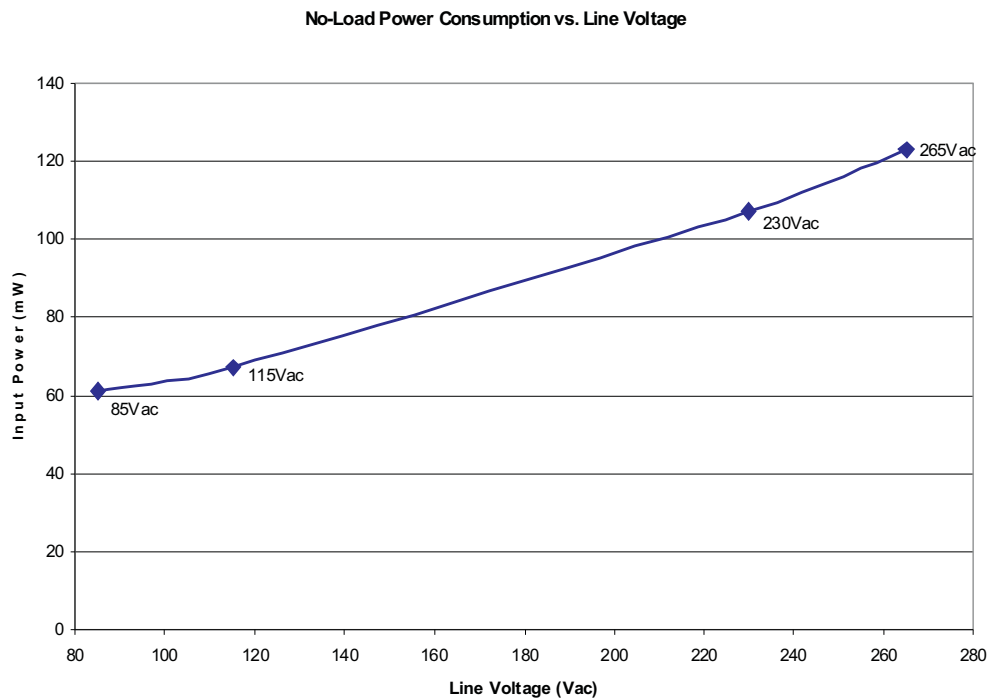

Figure 7. No-Load Input Power as a Function of Input Voltage

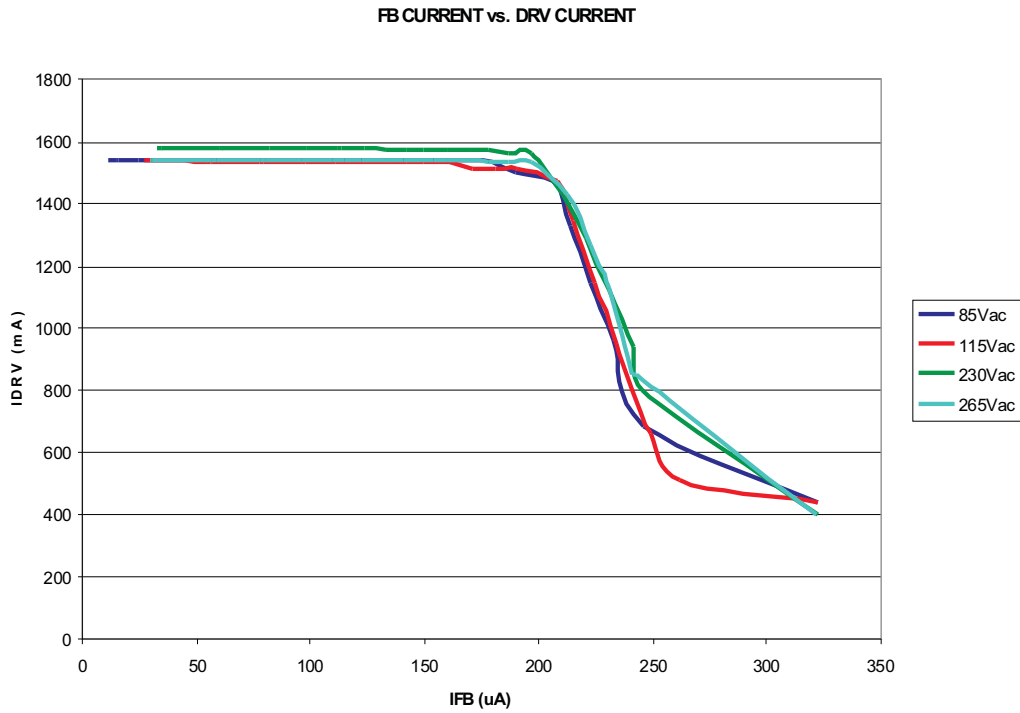

Figure 8. DRV Current as a Function of FB Current

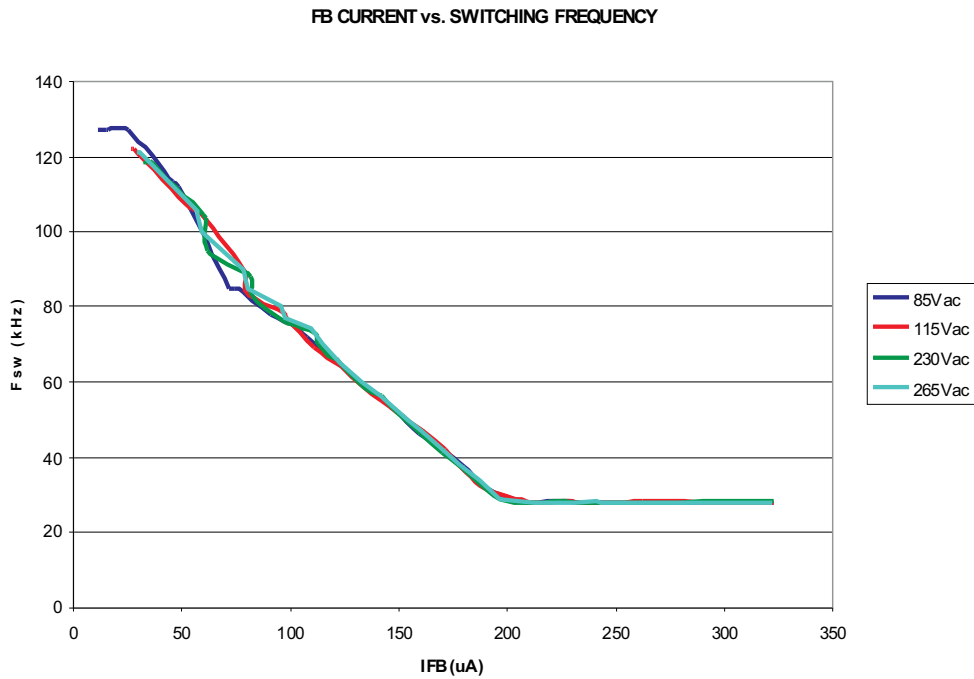

Figure 9. Switching Frequency as a Function of FB Current

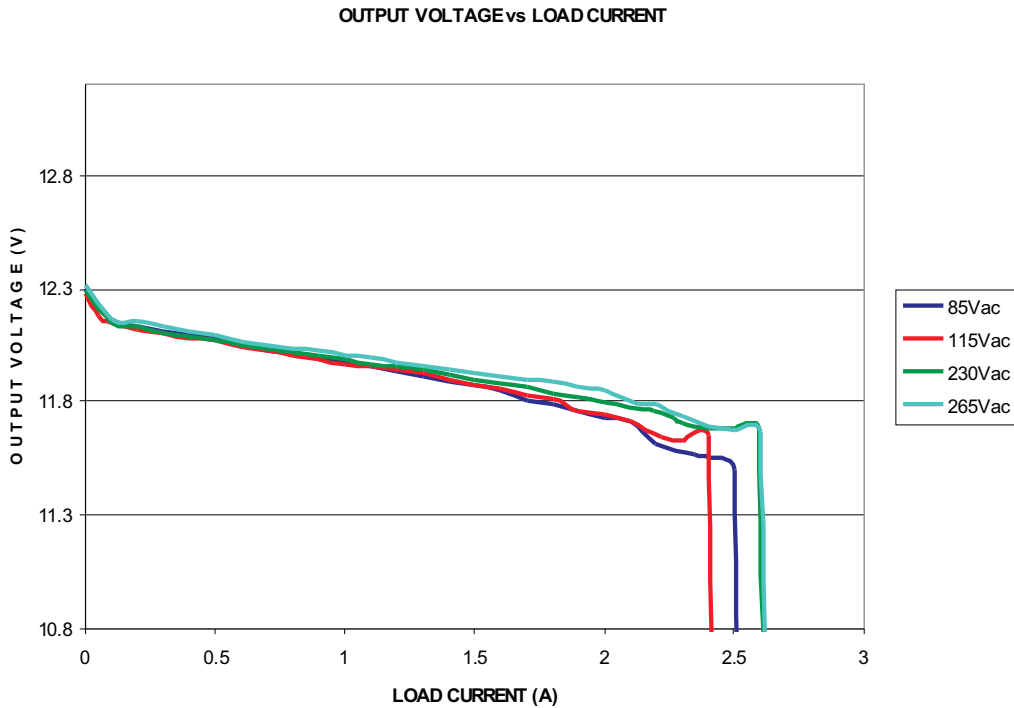

Figure 10. Output Voltage as a Function of Load Current and Line Voltage (Note the shutdown/retry threshold for each line voltage.)

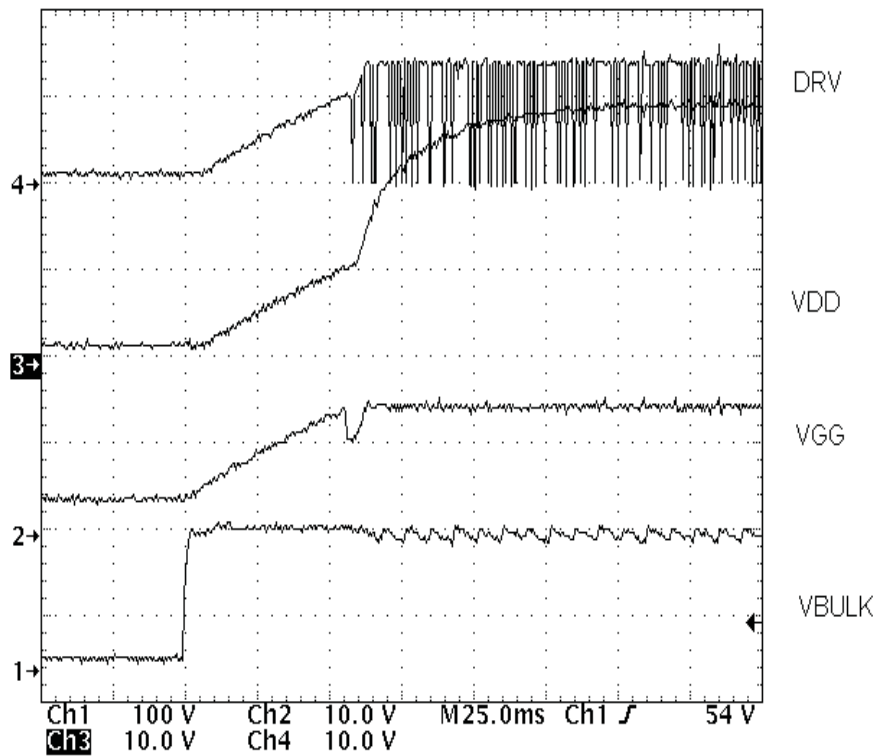

Figure 11. Start-Up Waveform (Input voltage = 115 V_{AC}, full load. Ch.1 = bulk input voltage, 100 V/div., Ch.2 = VGG, 10 V/div., Ch.3 = VDD, 10V/div., Ch.4 = DRV, 10V/div.)

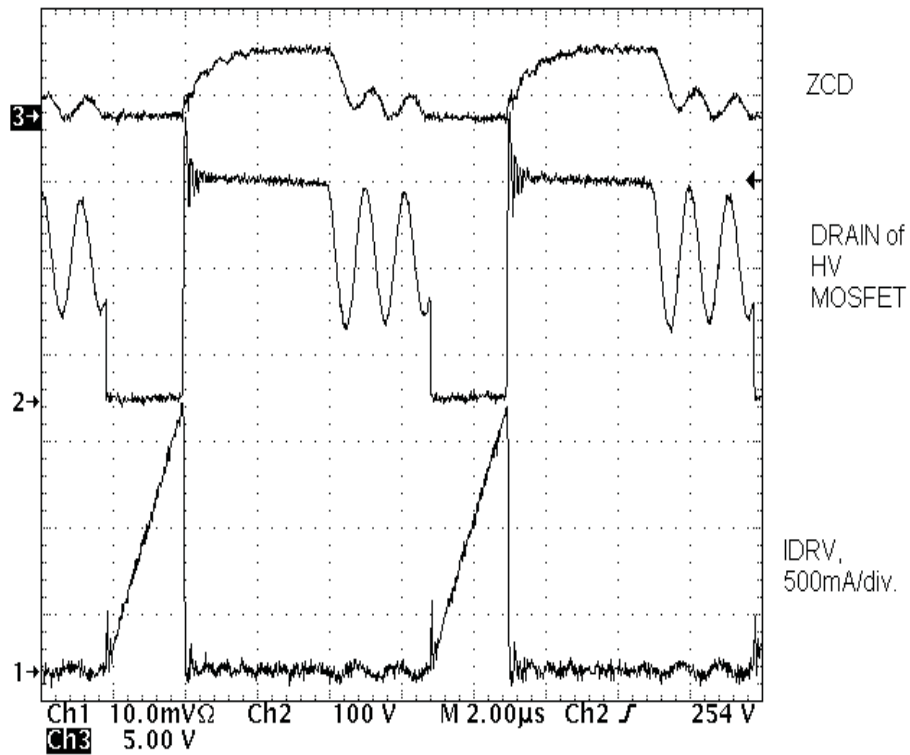

Figure 12. FM Mode Switching Cycle Waveform
 (Input voltage = 115 V_{AC}, full load, $f_{sw} = 112$ kHz. Ch.1 = I_{DRV} , 500 mA/div., $I_{DRV} = 1.53$ A, Ch.2 = Drain of HV MOSFET, 100 V/div., Ch.3 = ZCD, 5 V/div.)

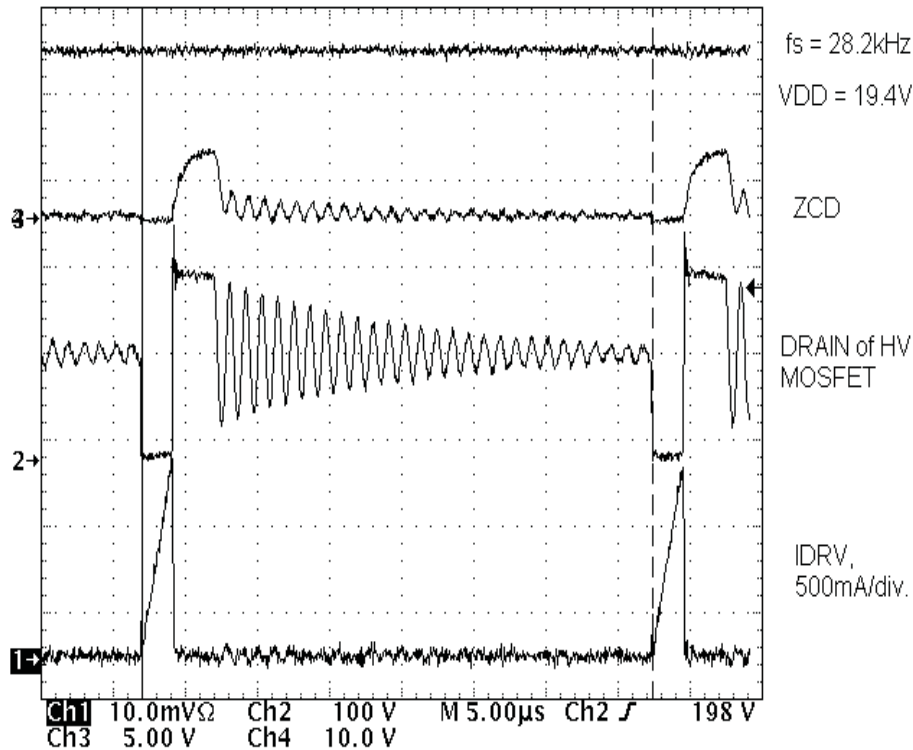

Figure 13. AM Mode Switching Cycle Waveform
 (Input voltage = 85 V_{AC}, 0.3-A load, $f_{sw} = 28.2$ kHz, Ch.1 = I_{DRV} , 500 mA/div., $I_{DRV} = 1.1$ A, Ch.2 = Drain of HV MOSFET, 100 V/div., Ch.3 = ZCD, 5 V/div., Ch. 4 = VDD, 10 V/div.)

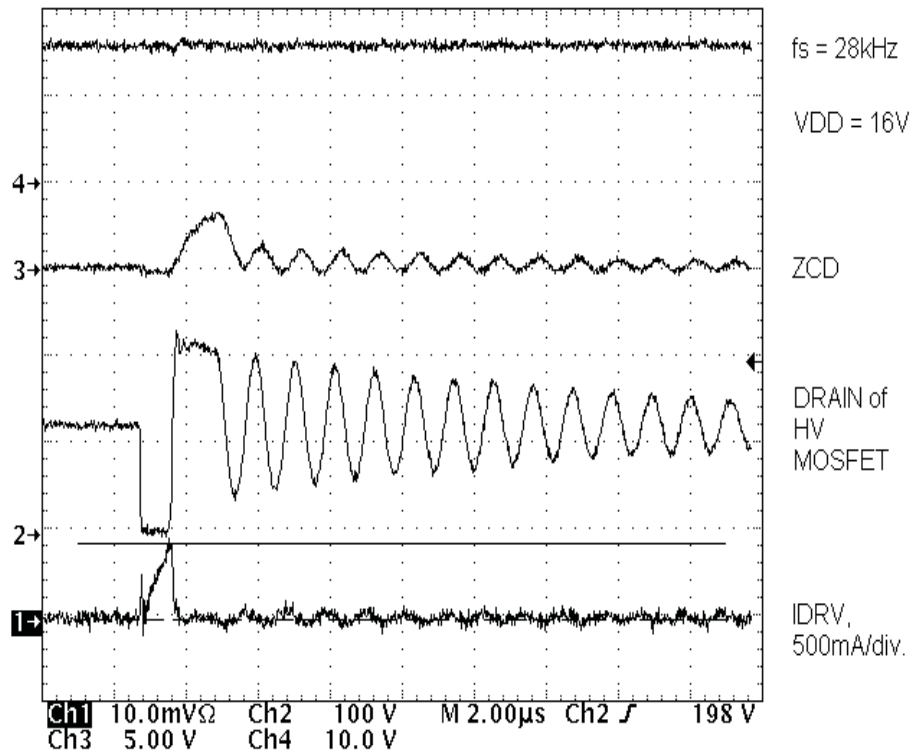

Figure 14. GM Mode Switching Cycle Waveform
(Input voltage = 85 V_{AC}, 0-A load, f_{SW} = 28 kHz, Ch.1 = I_{DRV}, 500 mA/div., I_{DRV} = 440 mA, Ch.2 = Drain of HV MOSFET, 100 V/div., Ch.3 = ZCD, 5 V/div., Ch. 4 = VDD, 10 V/div.)

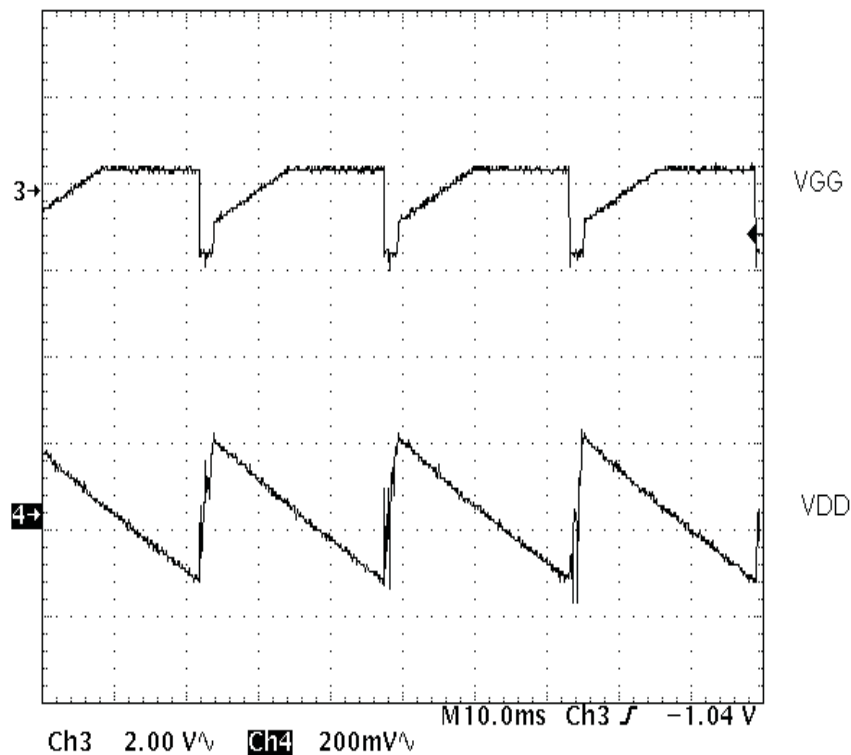

Figure 15. Ripple on VGG and VDD During Green Mode Operation
(Ch.3 = VGG, AC coupled, 2 V/div., Ch.4 = VDD, AC coupled, 200 mV/div.)

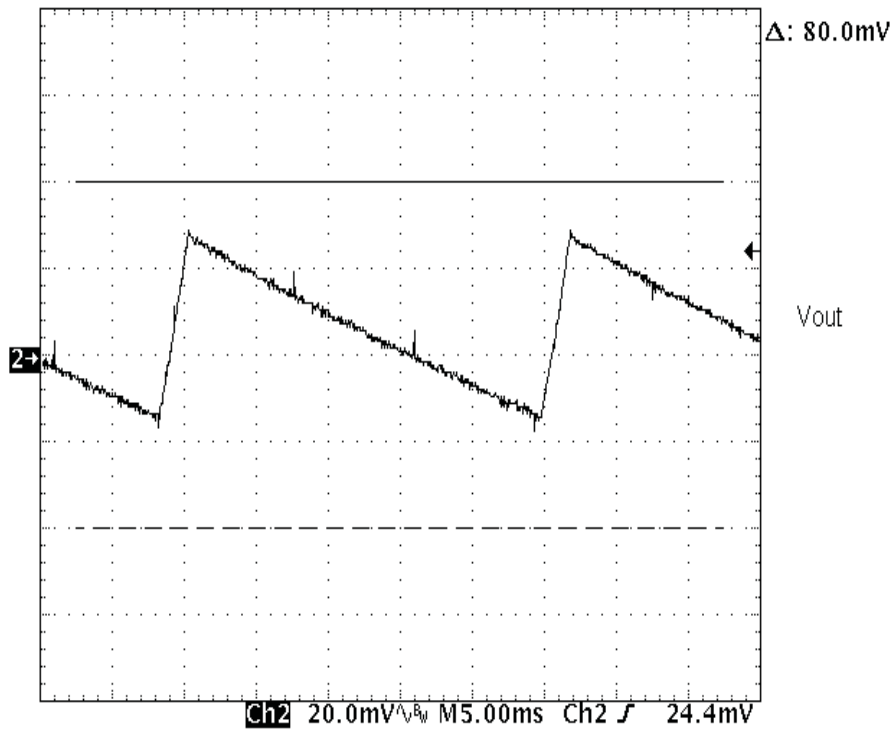

Figure 16. Output Voltage Ripple During Green Mode Operation (Input voltage = 85 V_{AC}, no load. Ch.2 = V_{OUT}, AC coupled, 20 mV/div.)

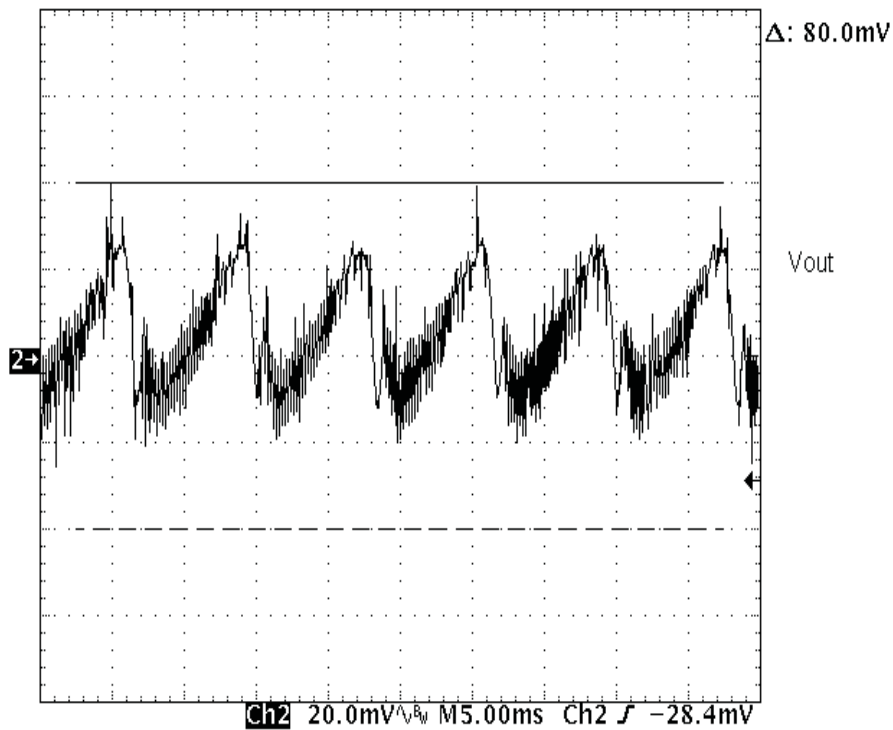

Figure 17. Output Voltage Ripple During Frequency Modulation Mode (Input voltage = 85 V_{AC}, full load. Ch.2 = V_{OUT}, AC coupled, 20 mV/div.)

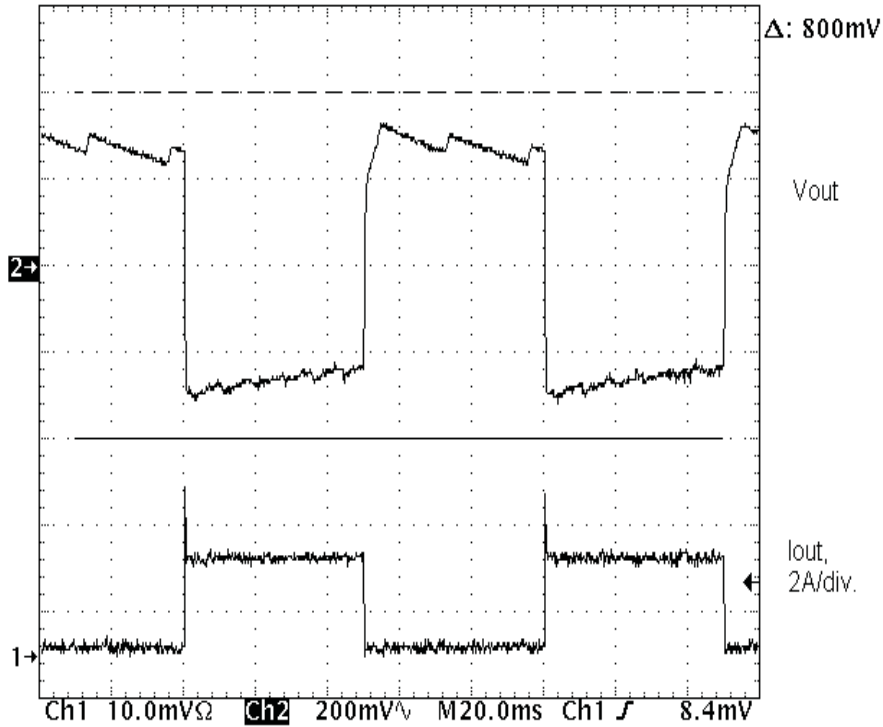

Figure 18. Load Transient, 0% to 100% Load Step (Ch.1 = I_{OUT} , 2 A/div., Ch.2 = V_{OUT} , AC coupled, 200 mV/div.)

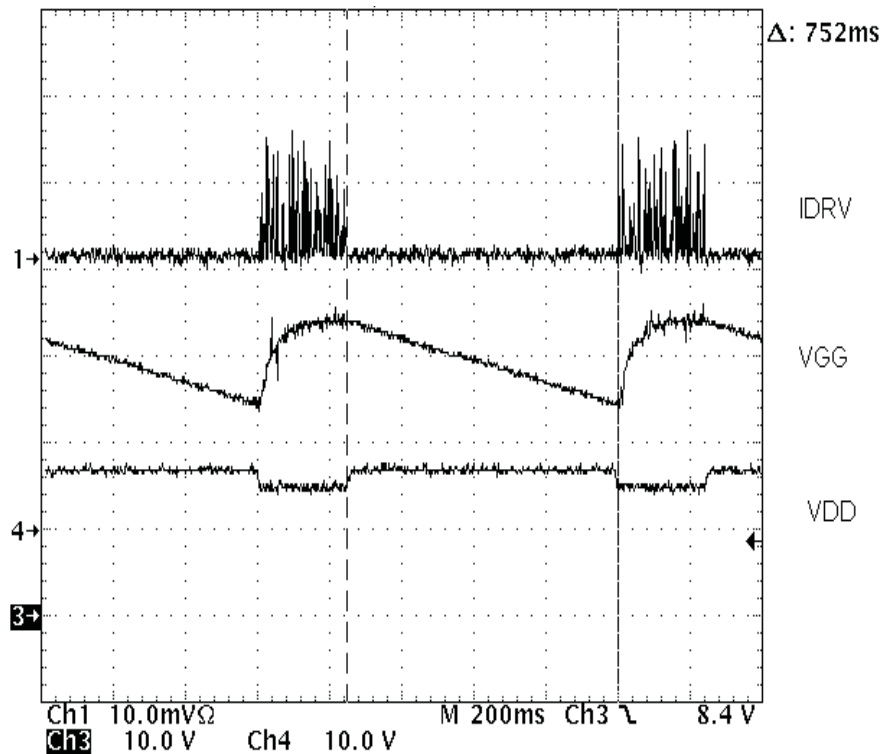

Figure 19. Brown-Out Protection (MOT shutdown/retry response triggered at full load when input voltage dropped to 72.4 V_{AC}. Note the 750-ms t_{RETRY} . Ch.1 = I_{DRV} , Ch.3 = VDD, 10 V/div., Ch.4 = VGG, 10 V/div.)

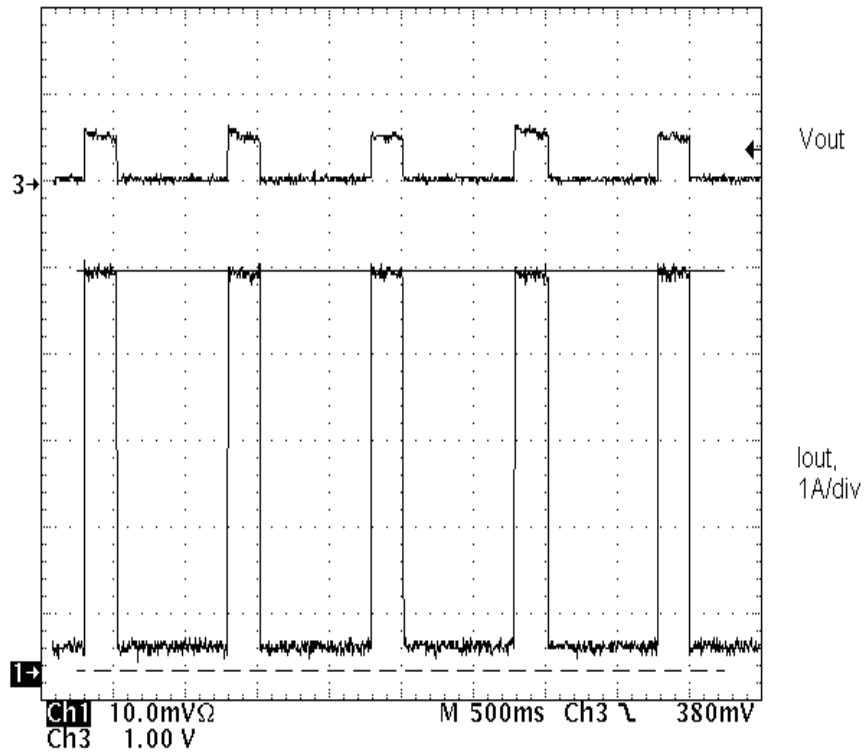

Figure 20. Output Short Circuit Protection

(Short circuit maintained on output; note the output current goes to 4.62 A, refer to equation 13 in the data sheet, during the 250-ms delay to overload fault, t_{OL} , and retries after $t_{RETRY} = 750$ ms. Input voltage = 85 V_{AC}. Ch.1 = I_{OUT} , 1 A/div., Ch. 3 = V_{OUT} , 1 V/div.)

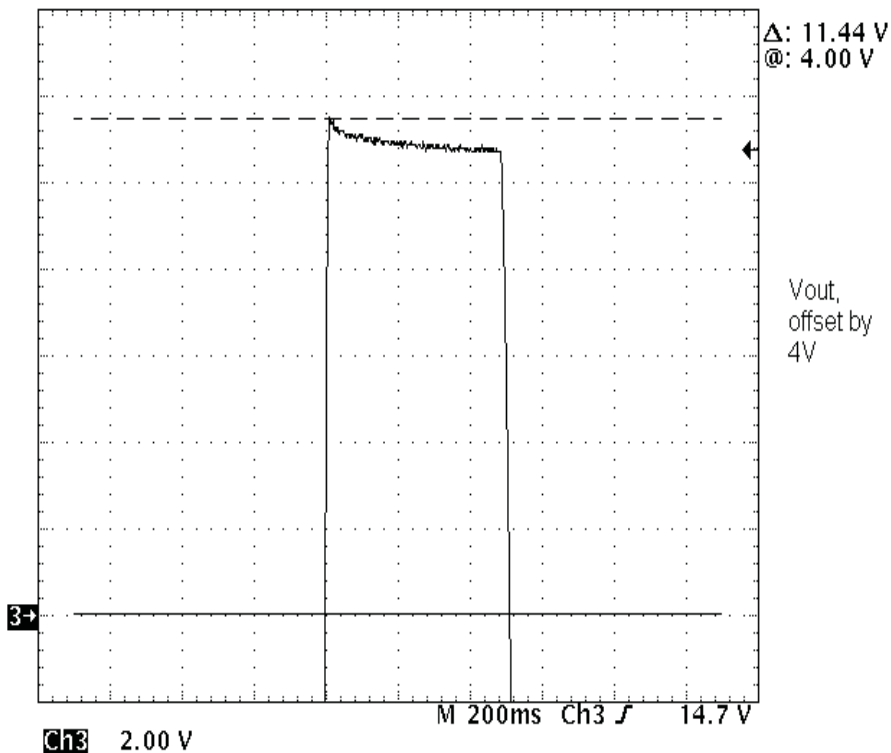

Figure 21. Output Over Voltage Protection

(The EVM was tested with an open FB loop, no load. OVP threshold is equal to 15.44 V. Ch. 3 = V_{OUT} , 2 V/div., offset by 4 V.)

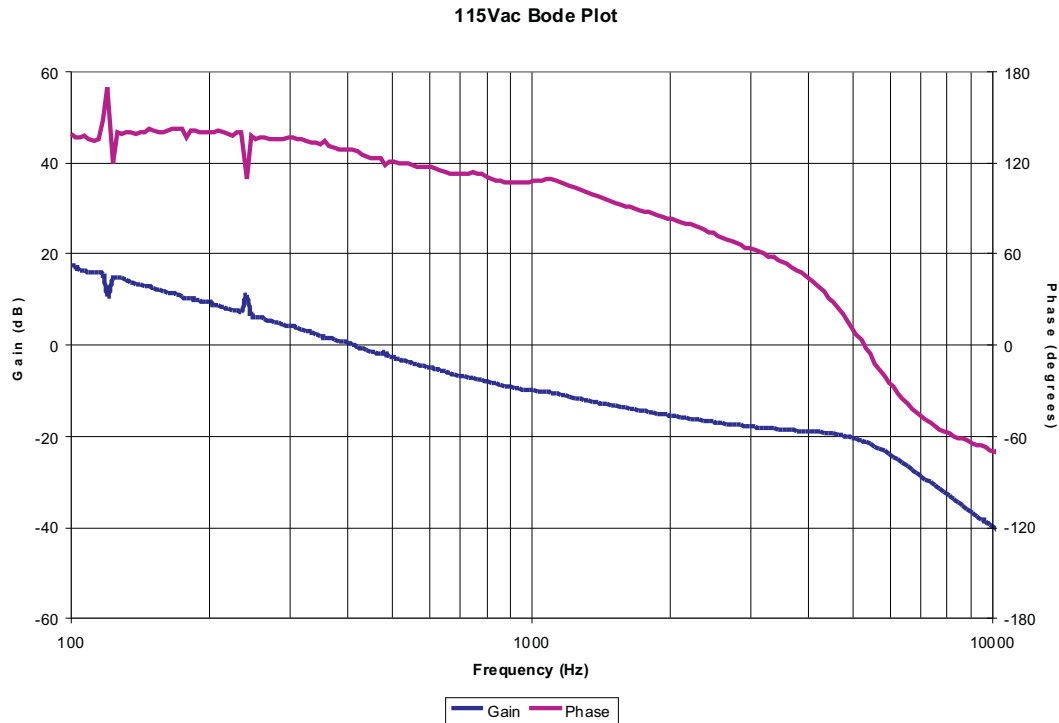

Figure 22. Bode Plot (Input voltage = 115 V_{AC}, full load.)

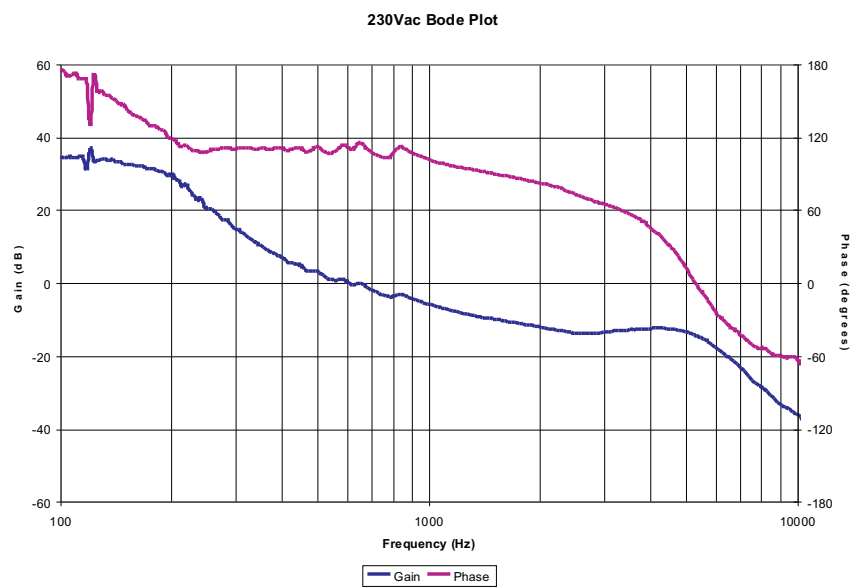

Figure 23. Bode Plot (Input voltage = 230 V_{AC}, full load.)

8 EVM Assembly Drawing and Layout

Figure 24 through Figure 26 show the design of the UCC28610EVM-474 printed circuit board.

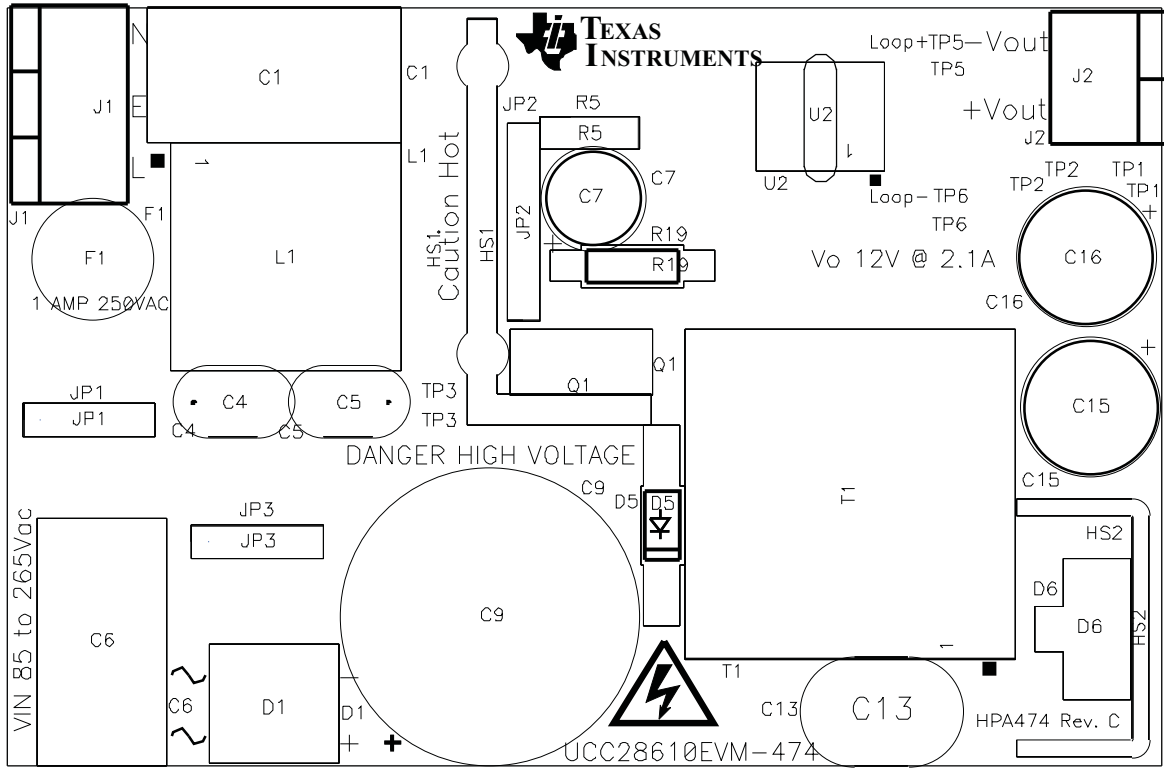

Figure 24. Top Layer Component Placement

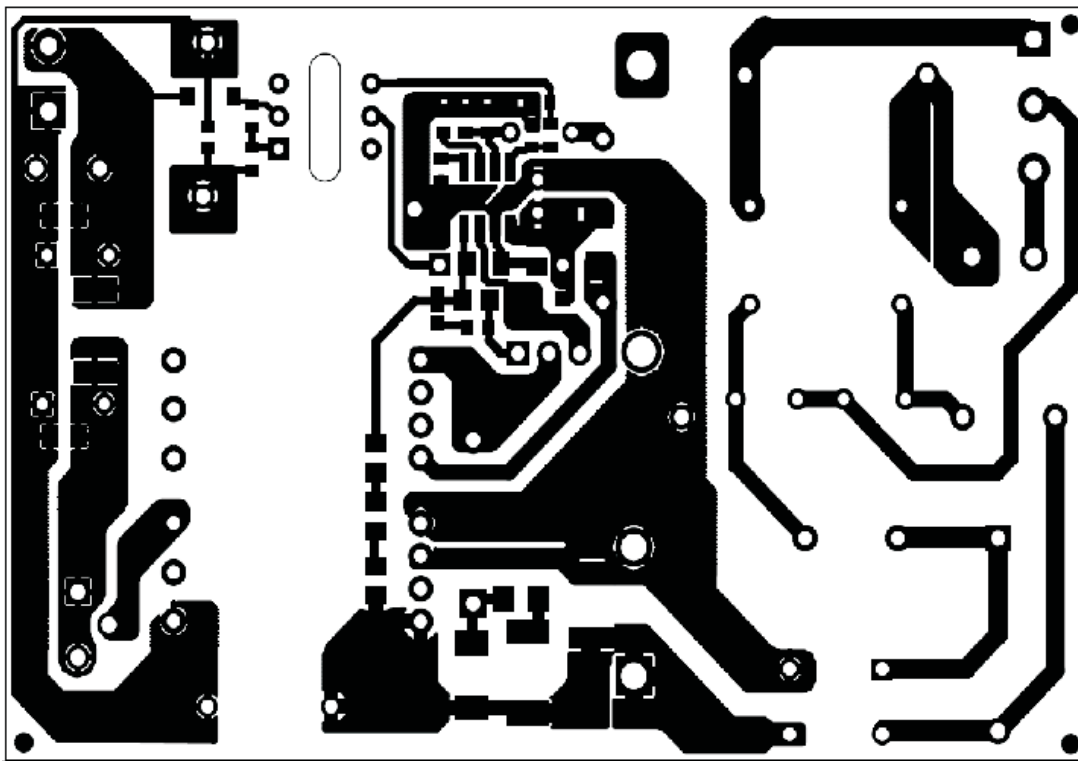

Figure 25. Bottom Layer Routing

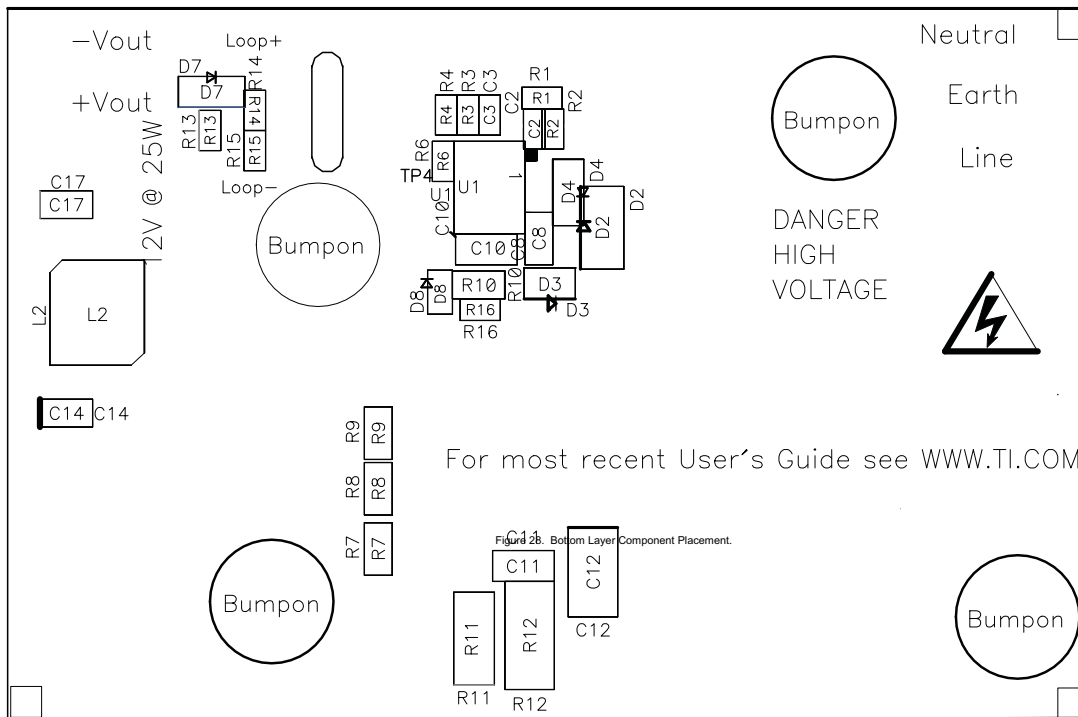

Figure 26. Bottom Layer Component Placement

9 List of Materials

Table 3. List of Materials for UCC28610EVM-474

COUNT	REF DES	DESCRIPTION	PART NUMBER	MFR
2	C1, C6	Capacitor, film, 0.33 μ F, 275 VAC, X2, \pm 20%, 0.690 x 0.374 inch	ECQ-U2A334ML	Panasonic
1	C2	Capacitor, ceramic, 100 pF, 50 V, NP0, \pm 5%, 0603	Std	Std
0	C3	Capacitor, ceramic, not populated, 50 V, NP0, \pm 5%, 0603	Std	Std
2	C4, C5 (optional)	Capacitor, ceramic, 2200 pF, 250 VAC, X1/Y2, \pm 20%, 0.315 x 0.200 inch	DE2E3KY222MA2BM01	muRata
1	C7	Capacitor, aluminum electrolytic, 68 μ F, 35 V, \pm 20%, 0.200 inch	EEU-FC1V680	Panasonic
1	C8	Capacitor, ceramic, 0.1 μ F, 50 V, X7R, \pm 10%, 0805	CC0805KRX7R9BB104	Yageo Corporation
1	C9	Capacitor, aluminum electrolytic, 100 μ F, 400 VDC, \pm 20%, 25 x 20 mm	EET-HC2G101BA	Panasonic
1	C10	Capacitor, ceramic, 0.1 μ F, 100 V, X7R, \pm 10%, 1206	Std	Std
1	C11	Capacitor, ceramic, 330 pF, 630 V, C0G, NP0, \pm 5%, 1206	Std	Std
1	C12	Capacitor, ceramic, 0.1 μ F, 630 V, X7R, \pm 10%, 1812	C4532X7R2J104K	TDK Corporation
1	C13	Capacitor, ceramic disk, 1000 pF, 250 V, Y1/X1, \pm 20%, 0.394 x 0.315 inch	ECK-ANA102MB	Panasonic
2	C14, C17	Capacitor, ceramic, 1 μ F, 25 V, X5R, \pm 10%, 0805	Std	Std
2	C15, C16	Capacitor, aluminum electrolytic, 680 μ F, 25 V, \pm 20%, 10 x 25 mm	EEU-FM1E681	Panasonic
1	D1	Diode, bridge, 1 A, 600 V	DF06M	Diodes Inc.
1	D2	Diode, ultra fast, 1 A, 200 V, SMA	MURA120T3G	On Semiconductor
1	D3	Diode, schottky, 100 mA, 40 V, SOD-323	RB501V-40TE-17	Rohm Semiconductor
1	D4	Diode, Zener, 25 V, 500 mW, SOD-123	MMSZ5253BT1G	On Semiconductor
1	D5	Diode, fast recovery glass passivated, 1 A, 1 kV, DO-41	UF4007-TP	Micro Commercial Co.
1	D6	Diode, dual Schottky, 20 A, 100 V, TO-220	STPS20H100CT	STMicroelectronics
1	D7	Diode, Zener, 10 V, 500 mW, SOD-123	MMSZ5240B	Fairchild Semiconductor
1	D8	Diode, Schottky barrier, 1 A, 30 V, SMini2-F2	MA21D3400L	Panasonic - SSG
1	F1	Fuse, slow blow, 1 A, 250 V, 0.335 inch	38211000410	Littelfuse / Wickmann
1	HS1	Heatsink, TO-220, vertical-mount, 0.5 x 0.750 inch	507302B00000	Aavid Thermalloy
1	HS2	Heatsink, alloy 1110 copper, 0.530 x 1.200 inch	HS001	NH Stamp
1	L1	Inductor, AC line, common choke, 27 mH, 1 A, 0.660 x 0.670 inch	54P512-276	Vitec Electronics Corp.
1	L2	Inductor, high current choke, 3.3 μ H, 0.276 x 0.288 inch	HCP0703-3R3-R	Coiltronics/Cooper
1	Q1	MOSFET, Nch, 600 V, 6 A, SC-67	2SK3562	Toshiba

Table 3. List of Materials for UCC28610EVM-474 (continued)

COUNT	REF DES	DESCRIPTION	PART NUMBER	MFR
1	R1	Resistor, chip, 100 k Ω , 1/10 W, $\pm 1\%$, 0603	Std	Std
1	R2	Resistor, chip, 20.5 k Ω , 1/10 W, $\pm 1\%$, 0603	Std	Std
1	R3	Resistor, chip, 51.1 k Ω , 1/10 W, $\pm 1\%$, 0603	Std	Std
1	R4	Resistor, chip, 64.9 k Ω , 1/10 W, $\pm 1\%$, 0603	Std	Std
1	R5	Resistor, metal film, 169 k Ω , 1/2 W, $\pm 1\%$, 0.300 x 0.100 inch	SFR16S0001693FR500	Vishay/BC Components
1	R6	Resistor, chip, 68.1 k Ω , 1/10 W, $\pm 1\%$, 0603	Std	Std
3	R7, R8, R9	Resistor, chip, 2.05M Ω , 1/8 W, 150V, $\pm 1\%$, 0805	CRCW08052M05FKEA	Vishay/Dale
1	R10	Resistor, chip, 15.4 Ω , 1/8 W, $\pm 1\%$, 0805	Std	Std
1	R11	Resistor, chip, 64.9 k Ω , 1/2 W, $\pm 1\%$, 2010	Std	Std
1	R12	Resistor, chip, 33.2 Ω , 1 W, $\pm 5\%$, 2512	Std	Std
1	R13	Resistor, chip, 20.5 Ω , 1/10 W, $\pm 1\%$, 0603	Std	Std
1	R14	Resistor, chip, 1.00 k Ω , 1/10 W, $\pm 1\%$, 0603	Std	Std
1	R15	Resistor, chip, 681 Ω , 1/10 W, $\pm 1\%$, 0603	Std	Std
1	R16	Resistor, chip, 0 Ω , 1/10 W, $\pm 1\%$, 0603	Std	Std
1	R19	Resistor, metal film, 1.00 k Ω , 1/4 W, $\pm 1\%$, TH-400	Std	Std
1	T1	Transformer, flyback, 220 μ H, PQ20/20	58P6936	Vitec Electronics
1	U1	Green-mode flyback controller, SO-8	UCC28610D	Texas Instruments
1	U2	Optocoupler, CTR 40% - 80%, 70 V _{ceo} , 5000 V _{RMS} , DIP6	CNY17F1M	Fairchild Optoelectronics

10 References

1. UCC28610 Green-Mode Flyback Controller, Datasheet, ([TI Literature Number SLUS888](#))
2. Standby and Low Power Measurements, VOLTECHNOTES, VPN 104-054/1, <http://www.voltech.com/Downloads/PMAppNotes/Low%20Power%20Standby.pdf>

Appendix A

A.1 UCC28610EVM-474 Rev. A

The following schematic, board layout, and list of materials apply to the UCC28610EVM-474 Rev. A version of the evaluation module. The Rev. A version of the EVM includes differential mode inductors L2 and L3. Subsequent revisions of the EVM replaced these inductors with a short circuit.

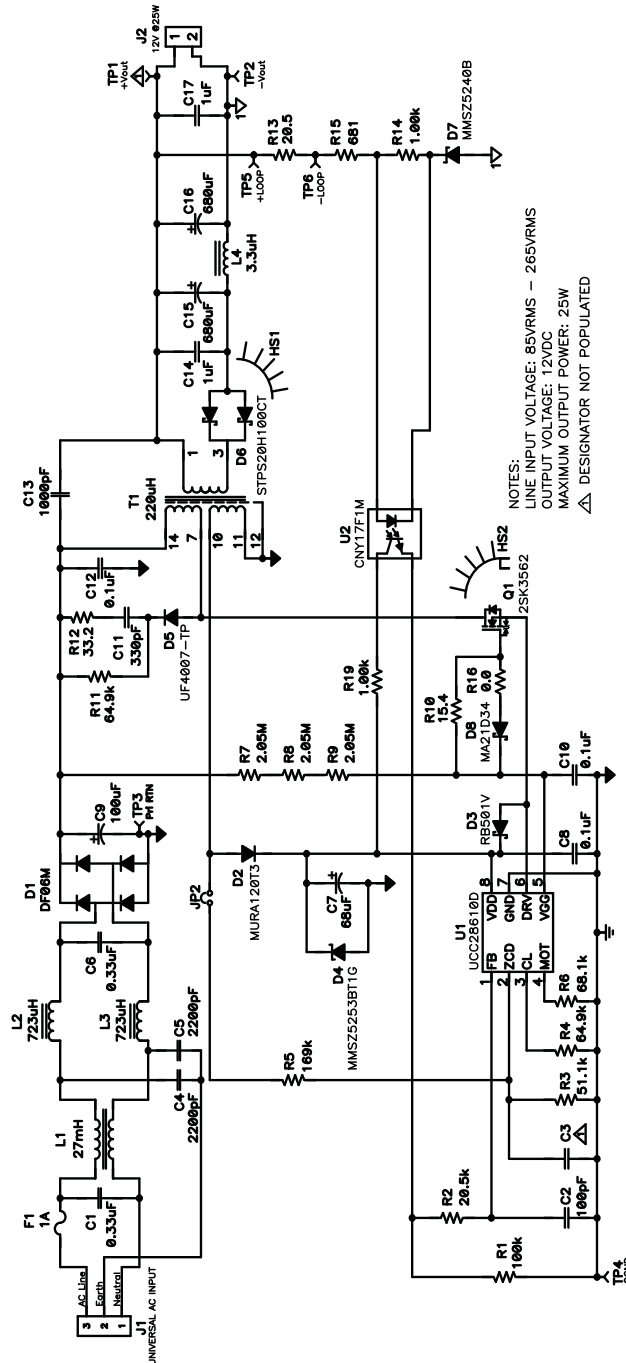

Figure 27. UCC28610EVM-474 Rev. A Schematic

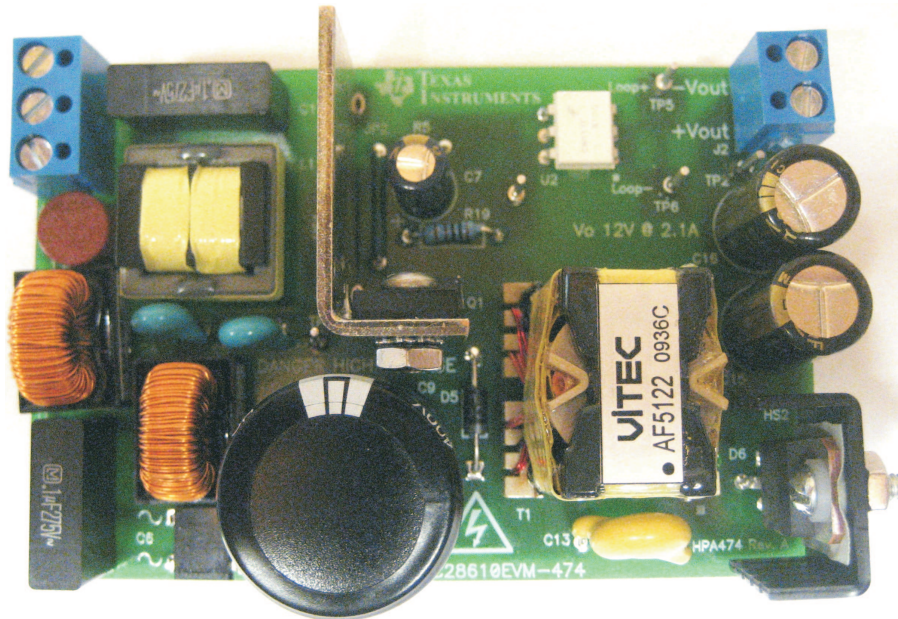

Figure 28. Top Side View of UCC28610EVM-474 Rev. A

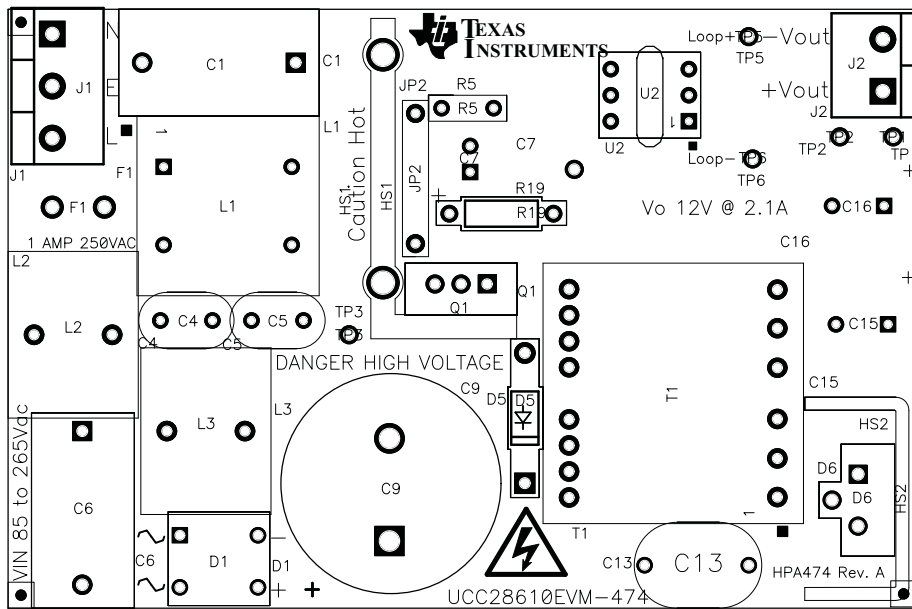

Figure 29. Top Layer Component Placement for UCC28610EVM-474 Rev. A

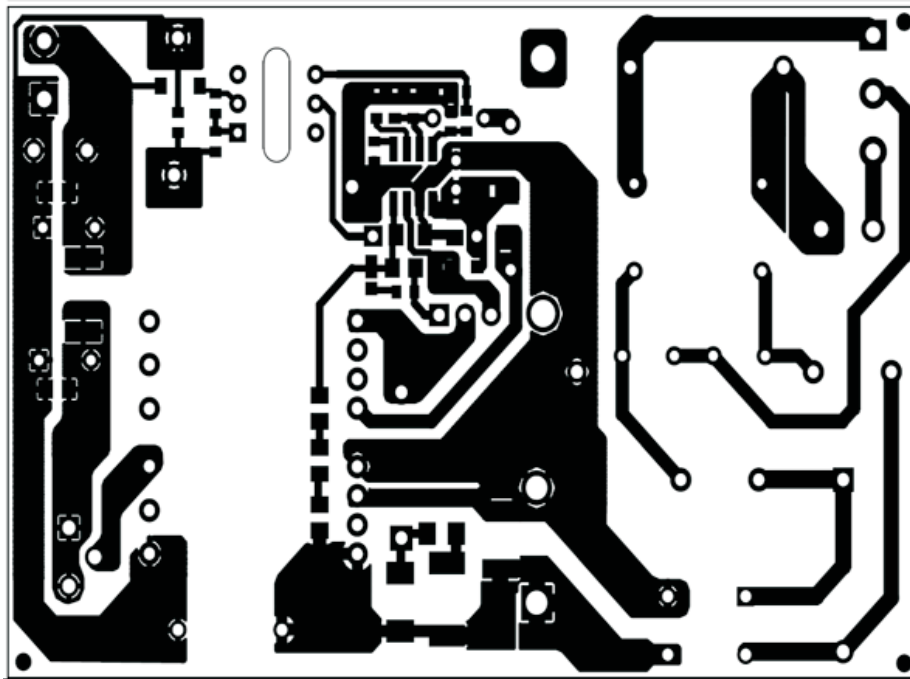

Figure 30. Bottom Layer Routing of UCC28610EVM-474 Rev. A

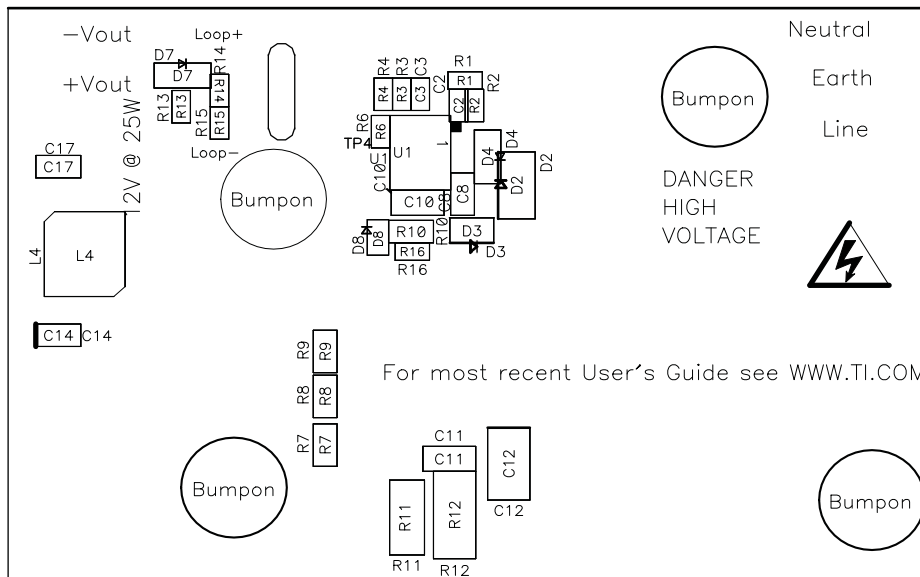

Figure 31. Bottom Layer Component Placement of UCC28610EVM-474 Rev. A

Table 4. Table 4. List of Materials for UCC28610EVM-474 Rev. A

COUNT	REF DES	DESCRIPTION	PART NUMBER	MFR
2	C1, C6	Capacitor, film, 0.33 μ F, 275VAC, X2, \pm 20%, 0.690 x 0.374 inch	ECQ-U2A334ML	Panasonic
1	C2	Capacitor, ceramic, 100 pF, 50 V, NP0, \pm 5%, 0603	Std	Std
0	C3	Capacitor, ceramic, not populated, 50 V, NP0, \pm 5%, 0603	Std	Std
2	C4, C5 (optional)	Capacitor, ceramic, 2200 pF, 250 VAC, X1/Y2, \pm 20%, 0.315 x 0.200 inch	DE2E3KY222MA2BM01	muRata
1	C7	Capacitor, aluminum electrolytic, 68 μ F, 35 V, \pm 20%, 0.200 inch	EEU-FC1V680	Panasonic
1	C8	Capacitor, ceramic, 0.1 μ F, 50 V, X7R, \pm 10%, 0805	CC0805KRX7R9BB104	Yageo Corporation
1	C9	Capacitor, aluminum electrolytic, 100 μ F, 400 VDC, \pm 20%, 25 x 20 mm	EET-HC2G101BA	Panasonic
1	C10	Capacitor, ceramic, 0.1 μ F, 100 V, X7R, \pm 10%, 1206	Std	Std
1	C11	Capacitor, ceramic, 330 pF, 630 V, C0G, NP0, \pm 5%, 1206	Std	Std
1	C12	Capacitor, ceramic, 0.1 μ F, 630 V, X7R, \pm 10%, 1812	C4532X7R2J104K	TDK Corporation
1	C13	Capacitor, ceramic disk, 1000 pF, 250 V, Y1/X1, \pm 20%, 0.394 x 0.315 inch	ECK-ANA102MB	Panasonic
2	C14, C17	Capacitor, ceramic, 1 μ F, 25 V, X5R, \pm 10%, 0805	Std	Std
2	C15, C16	Capacitor, aluminum electrolytic, 680 μ F, 25 V, \pm 20%, 10 x 25 mm	EEU-FM1E681	Panasonic
1	D1	Diode, bridge, 1 A, 600 V	DF06M	Diodes Inc.
1	D2	Diode, ultra fast, 1 A, 200 V, SMA	MURA120T3G	On Semiconductor
1	D3	Diode, Schottky, 100 mA, 40 V, SOD-323	RB501V-40TE-17	Rohm Semiconductor
1	D4	Diode, Zener, 500 mW, 25 V, SOD-123	MMSZ5253BT1G	On Semiconductor
1	D5	Diode, fast recovery glass passivated, 1 A, 1 kV, DO-41	UF4007-TP	Micro Commercial Co.
1	D6	Diode, dual Schottky, 20 A, 100 V, TO-220	STPS20H100CT	STMicroelectronics
1	D7	Diode, Zener, 10 V, 500 mW, SOD-123	MMSZ5240B	Fairchild Semiconductor
1	D8	Diode, Schottky barrier, 1 A, 30 V, SMini2-F2	MA21D3400L	Panasonic - SSG
1	F1	Fuse, slow blow, 1 A, 250 V, 0.335 inch	38211000410	Littelfuse / Wickmann
1	HS1	Heatsink, TO-220, vertical mount, 0.5 x 0.750 inch	507302B00000	Aavid Thermalloy
1	HS2	Heatsink, alloy 1110 copper, 0.530 x 1.200 inch	HS001	NH Stamp
1	L1	Inductor, AC line, common choke, 27 mH, 1 A, 0.660 x 0.670 inch	54P512-276	Vitec Electronics Corp.
2	L2, L3	Inductor, EMI, 723 μ H, 0.620 Ω , \pm 15%, 11.94 x 15.49 mm	54P2986	Vitec Electronics Corp.
1	L4	Inductor, high current choke, 3.3 μ H, 0.276 x 0.288 inch	HCP0703-3R3-R	Coiltronics/Cooper
1	Q1	MOSFET, N-channel, 600 V, 6A, SC-67	2SK3562	Toshiba

Table 4. Table 4. List of Materials for UCC28610EVM-474 Rev. A (continued)

COUNT	REF DES	DESCRIPTION	PART NUMBER	MFR
1	R1	Resistor, chip, 100 k Ω , 1/10 W, \pm 1%, 0603	Std	Std
1	R2	Resistor, chip, 20.5 k Ω , 1/10 W, \pm 1%, 0603	Std	Std
1	R3	Resistor, chip, 51.1 k Ω , 1/10 W, \pm 1%, 0603	Std	Std
1	R4	Resistor, chip, 64.9 k Ω , 1/10 W, \pm 1%, 0603	Std	Std
1	R5	Resistor, metal film, 169 k Ω , 1/2 W, \pm 1%, 0.300 x 0.100 inch	SFR16S0001693FR500	Vishay/BC Components
1	R6	Resistor, chip, 68.1 k Ω , 1/10 W, \pm 1%, 0603	Std	Std
3	R7, R8, R9	Resistor, chip, 2.05 M Ω , 1/8 W, 150 V, \pm 1%, 0805	CRCW08052M05FKEA	Vishay/Dale
1	R10	Resistor, chip, 15.4 W, 1/8 W, \pm 1%, 0805	Std	Std
1	R11	Resistor, chip, 64.9 k Ω , 1/2 W, \pm 1%, 2010	Std	Std
1	R12	Resistor, chip, 33.2 Ω , 1 W, \pm 5%, 2512	Std	Std
1	R13	Resistor, chip, 20.5 Ω , 1/10 W, \pm 1%, 0603	Std	Std
1	R14	Resistor, chip, 1.00 k Ω , 1/10 W, \pm 1%, 0603	Std	Std
1	R15	Resistor, chip, 681 Ω , 1/10 W, \pm 1%, 0603	Std	Std
1	R16	Resistor, chip, 0 Ω , 1/10 W, \pm 1%, 0603	Std	Std
1	R19	Resistor, metal film, 1.00 k Ω , 1/4 W, \pm 1%, TH-400	Std	Std
1	T1	Transformer, flyback, 220 μ H, PQ20/20	58P6936	Vitec Electronics
1	U1	Green-Mode Flyback Controller, SO-8	UCC28610D	Texas Instruments
1	U2	Optocoupler, CTR 40% - 80%, 70 V _{ceo} , 5000V _{rms} , DIP6	CNY17F1M	Fairchild Optoelectronics

EVALUATION BOARD/KIT IMPORTANT NOTICE

Texas Instruments (TI) provides the enclosed product(s) under the following conditions:

This evaluation board/kit is intended for use for **ENGINEERING DEVELOPMENT, DEMONSTRATION, OR EVALUATION PURPOSES ONLY** and is not considered by TI to be a finished end-product fit for general consumer use. Persons handling the product(s) must have electronics training and observe good engineering practice standards. As such, the goods being provided are not intended to be complete in terms of required design-, marketing-, and/or manufacturing-related protective considerations, including product safety and environmental measures typically found in end products that incorporate such semiconductor components or circuit boards. This evaluation board/kit does not fall within the scope of the European Union directives regarding electromagnetic compatibility, restricted substances (RoHS), recycling (WEEE), FCC, CE or UL, and therefore may not meet the technical requirements of these directives or other related directives.

Should this evaluation board/kit not meet the specifications indicated in the User's Guide, the board/kit may be returned within 30 days from the date of delivery for a full refund. **THE FOREGOING WARRANTY IS THE EXCLUSIVE WARRANTY MADE BY SELLER TO BUYER AND IS IN LIEU OF ALL OTHER WARRANTIES, EXPRESSED, IMPLIED, OR STATUTORY, INCLUDING ANY WARRANTY OF MERCHANTABILITY OR FITNESS FOR ANY PARTICULAR PURPOSE.**

The user assumes all responsibility and liability for proper and safe handling of the goods. Further, the user indemnifies TI from all claims arising from the handling or use of the goods. Due to the open construction of the product, it is the user's responsibility to take any and all appropriate precautions with regard to electrostatic discharge.

EXCEPT TO THE EXTENT OF THE INDEMNITY SET FORTH ABOVE, NEITHER PARTY SHALL BE LIABLE TO THE OTHER FOR ANY INDIRECT, SPECIAL, INCIDENTAL, OR CONSEQUENTIAL DAMAGES.

TI currently deals with a variety of customers for products, and therefore our arrangement with the user **is not exclusive.**

TI assumes **no liability for applications assistance, customer product design, software performance, or infringement of patents or services described herein.**

Please read the User's Guide and, specifically, the Warnings and Restrictions notice in the User's Guide prior to handling the product. This notice contains important safety information about temperatures and voltages. For additional information on TI's environmental and/or safety programs, please contact the TI application engineer or visit www.ti.com/esh.

No license is granted under any patent right or other intellectual property right of TI covering or relating to any machine, process, or combination in which such TI products or services might be or are used.

FCC Warning

This evaluation board/kit is intended for use for **ENGINEERING DEVELOPMENT, DEMONSTRATION, OR EVALUATION PURPOSES ONLY** and is not considered by TI to be a finished end-product fit for general consumer use. It generates, uses, and can radiate radio frequency energy and has not been tested for compliance with the limits of computing devices pursuant to part 15 of FCC rules, which are designed to provide reasonable protection against radio frequency interference. Operation of this equipment in other environments may cause interference with radio communications, in which case the user at his own expense will be required to take whatever measures may be required to correct this interference.

EVM WARNINGS AND RESTRICTIONS

It is important to operate this EVM within the input voltage range of 85 V_{AC} to 265 V_{AC} and the output voltage of 12 V .

Exceeding the specified input range may cause unexpected operation and/or irreversible damage to the EVM. If there are questions concerning the input range, please contact a TI field representative prior to connecting the input power.

Applying loads outside of the specified output range may result in unintended operation and/or possible permanent damage to the EVM. Please consult the EVM User's Guide prior to connecting any load to the EVM output. If there is uncertainty as to the load specification, please contact a TI field representative.

During normal operation, some circuit components may have case temperatures greater than 60 °C. The EVM is designed to operate properly with certain components above as long as the input and output ranges are maintained. These components include but are not limited to linear regulators, switching transistors, pass transistors, and current sense resistors. These types of devices can be identified using the EVM schematic located in the EVM User's Guide. When placing measurement probes near these devices during operation, please be aware that these devices may be very warm to the touch.

Mailing Address: Texas Instruments, Post Office Box 655303, Dallas, Texas 75265
Copyright © 2010, Texas Instruments Incorporated

IMPORTANT NOTICE

Texas Instruments Incorporated and its subsidiaries (TI) reserve the right to make corrections, modifications, enhancements, improvements, and other changes to its products and services at any time and to discontinue any product or service without notice. Customers should obtain the latest relevant information before placing orders and should verify that such information is current and complete. All products are sold subject to TI's terms and conditions of sale supplied at the time of order acknowledgment.

TI warrants performance of its hardware products to the specifications applicable at the time of sale in accordance with TI's standard warranty. Testing and other quality control techniques are used to the extent TI deems necessary to support this warranty. Except where mandated by government requirements, testing of all parameters of each product is not necessarily performed.

TI assumes no liability for applications assistance or customer product design. Customers are responsible for their products and applications using TI components. To minimize the risks associated with customer products and applications, customers should provide adequate design and operating safeguards.

TI does not warrant or represent that any license, either express or implied, is granted under any TI patent right, copyright, mask work right, or other TI intellectual property right relating to any combination, machine, or process in which TI products or services are used. Information published by TI regarding third-party products or services does not constitute a license from TI to use such products or services or a warranty or endorsement thereof. Use of such information may require a license from a third party under the patents or other intellectual property of the third party, or a license from TI under the patents or other intellectual property of TI.

Reproduction of TI information in TI data books or data sheets is permissible only if reproduction is without alteration and is accompanied by all associated warranties, conditions, limitations, and notices. Reproduction of this information with alteration is an unfair and deceptive business practice. TI is not responsible or liable for such altered documentation. Information of third parties may be subject to additional restrictions.

Resale of TI products or services with statements different from or beyond the parameters stated by TI for that product or service voids all express and any implied warranties for the associated TI product or service and is an unfair and deceptive business practice. TI is not responsible or liable for any such statements.

TI products are not authorized for use in safety-critical applications (such as life support) where a failure of the TI product would reasonably be expected to cause severe personal injury or death, unless officers of the parties have executed an agreement specifically governing such use. Buyers represent that they have all necessary expertise in the safety and regulatory ramifications of their applications, and acknowledge and agree that they are solely responsible for all legal, regulatory and safety-related requirements concerning their products and any use of TI products in such safety-critical applications, notwithstanding any applications-related information or support that may be provided by TI. Further, Buyers must fully indemnify TI and its representatives against any damages arising out of the use of TI products in such safety-critical applications.

TI products are neither designed nor intended for use in military/aerospace applications or environments unless the TI products are specifically designated by TI as military-grade or "enhanced plastic." Only products designated by TI as military-grade meet military specifications. Buyers acknowledge and agree that any such use of TI products which TI has not designated as military-grade is solely at the Buyer's risk, and that they are solely responsible for compliance with all legal and regulatory requirements in connection with such use.

TI products are neither designed nor intended for use in automotive applications or environments unless the specific TI products are designated by TI as compliant with ISO/TS 16949 requirements. Buyers acknowledge and agree that, if they use any non-designated products in automotive applications, TI will not be responsible for any failure to meet such requirements.

Following are URLs where you can obtain information on other Texas Instruments products and application solutions:

Products

Audio	www.ti.com/audio
Amplifiers	amplifier.ti.com
Data Converters	dataconverter.ti.com
DLP® Products	www.dlp.com
DSP	dsp.ti.com
Clocks and Timers	www.ti.com/clocks
Interface	interface.ti.com
Logic	logic.ti.com
Power Mgmt	power.ti.com
Microcontrollers	microcontroller.ti.com
RFID	www.ti-rfid.com
RF/IF and ZigBee® Solutions	www.ti.com/lprf

Applications

Communications and Telecom	www.ti.com/communications
Computers and Peripherals	www.ti.com/computers
Consumer Electronics	www.ti.com/consumer-apps
Energy and Lighting	www.ti.com/energy
Industrial	www.ti.com/industrial
Medical	www.ti.com/medical
Security	www.ti.com/security
Space, Avionics and Defense	www.ti.com/space-avionics-defense
Transportation and Automotive	www.ti.com/automotive
Video and Imaging	www.ti.com/video
Wireless	www.ti.com/wireless-apps

TI E2E Community Home Page

e2e.ti.com

Mailing Address: Texas Instruments, Post Office Box 655303, Dallas, Texas 75265
Copyright © 2011, Texas Instruments Incorporated