

## Surface Mount Ultrafast Rectifier Diode

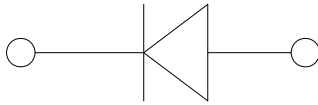
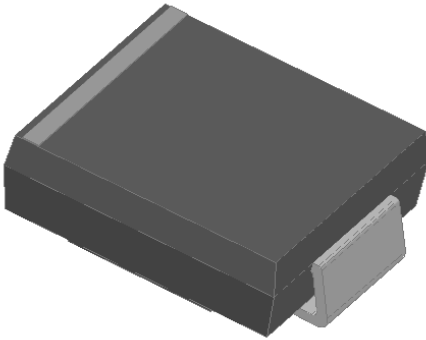

### Features

- Ultrafast reverse recovery time
- Low leakage current
- Low switching losses, high efficiency
- High forward surge capability
- Solder dip 260 °C max. 10 s, per JESD 22-B106

### Typical Applications

For use in high frequency rectification and freewheeling application in switching mode converters and inverters for consumer, computer and telecommunication.

### Mechanical Data

- **Package:** DO-214AB (SMC)  
Molding compound meets UL 94 V-0 flammability rating, RoHS-compliant
- **Terminals:** Tin plated leads, solderable per J-STD-002 and JESD22-B102
- **Polarity:** Color band denotes the cathode end

### ■ Maximum Ratings (T<sub>a</sub>=25°C Unless otherwise specified)

PARAMETER	SYMBOL	UNIT	MURS320
Device marking code			MURS320
Repetitive Peak Reverse Voltage	V <sub>RRM</sub>	V	200
Average Rectified Output Current @60Hz sine wave, Resistance load, TL (FIG.1)	I <sub>O</sub>	A	3.0
Forward Surge Current (Non-repetitive) @60Hz Half-sine wave, 1 cycle, T <sub>a</sub> =25°C	I <sub>FSM</sub>	A	100
Typical junction capacitance@ Measured at 1MHZ and Applied Reverse Voltage of 4.0 V.D.C.	C <sub>j</sub>	pF	63
Storage Temperature	T <sub>stg</sub>	°C	-55 ~+150
Junction Temperature	T <sub>j</sub>	°C	-55 ~+150

### ■ Electrical Characteristics (T<sub>a</sub>=25°C Unless otherwise specified)

PARAMETER	SYMBOL	UNIT	TEST CONDITIONS	MURS320
Maximum instantaneous forward voltage drop per diode	V <sub>F</sub>	V	I <sub>FM</sub> =3.0A	0.92
Maximum reverse recovery time	T <sub>RR</sub>	ns	I <sub>F</sub> =0.5A, I <sub>R</sub> =1.0A, I <sub>rr</sub> =0.25A	35
Maximum DC reverse current at rated DC blocking voltage per diode	I <sub>R</sub>	μA	T <sub>a</sub> =25°C	5
			T <sub>a</sub> =125°C	50



# MURS320

## ■ Thermal Characteristics (T<sub>a</sub>=25°C Unless otherwise specified)

PARAMETER		SYMBOL	UNIT	MURS320
Typical Thermal Resistance	Junction to ambient	R <sub>θJ-A</sub>	°C/W	65 <sup>1)</sup>
	Junction to lead	R <sub>θJ-L</sub>		20 <sup>1)</sup>
	Junction to case	R <sub>θJ-C</sub>		15 <sup>1)</sup>

Note(1)

Thermal resistance from junction to ambient and from junction to lead mounted on P.C.B. with 0.6" x 0.6" (16 mm x 16 mm) copper pad areas

## ■ Ordering Information (Example)

PREFERRED P/N	PACKAGE CODE	UNIT WEIGHT(g)	MINIMUM PACKAGE(pcs)	INNER BOX QUANTITY(pcs)	OUTER CARTON QUANTITY(pcs)	DELIVERY MODE
MURS320	F1	Approximate 0.248	3000	6000	42000	13" reel

## ■ Characteristics(Typical)

FIG.1: I<sub>o</sub>-T<sub>L</sub> Curve

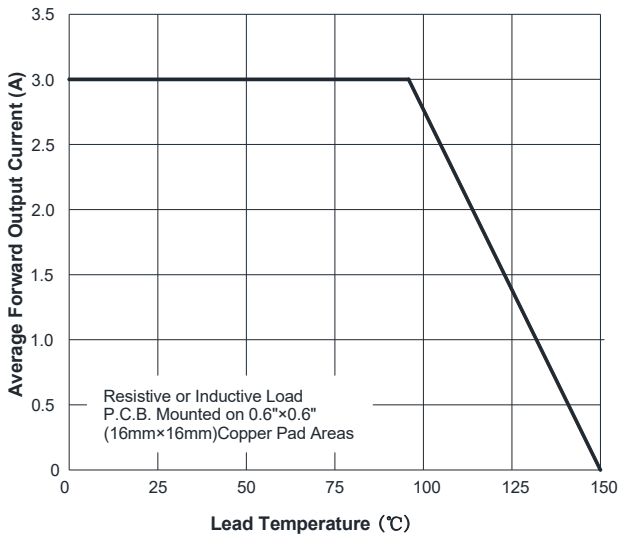

FIG.2: Forward Surge Current Capacity

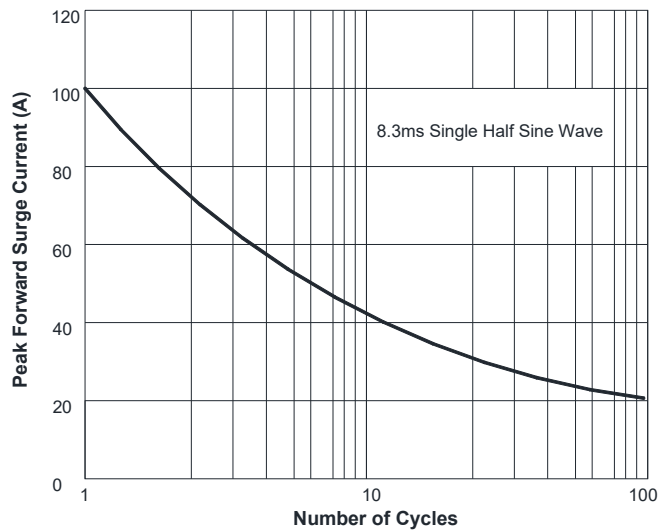

FIG.3: Typical Forward Voltage

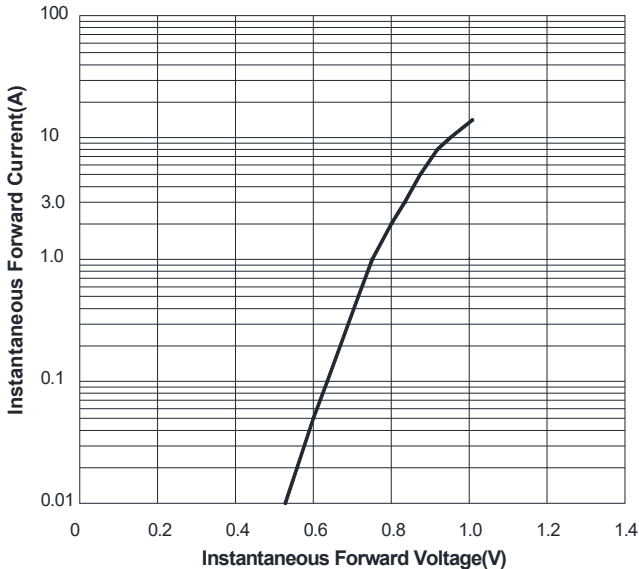

FIG.4: Typical Reverse Characteristics

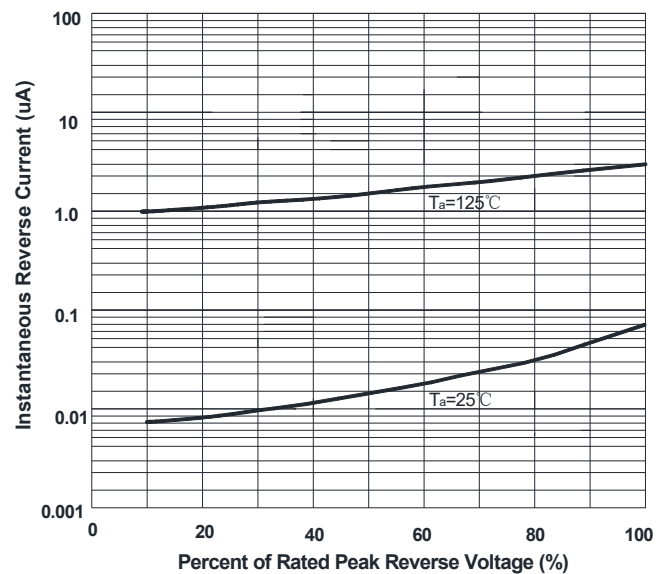
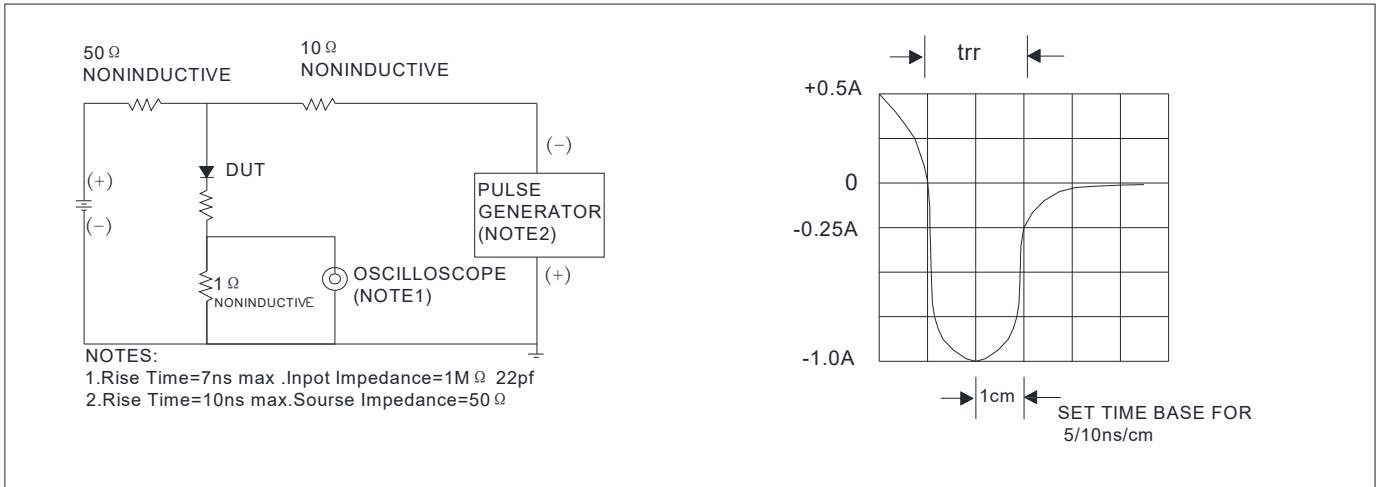
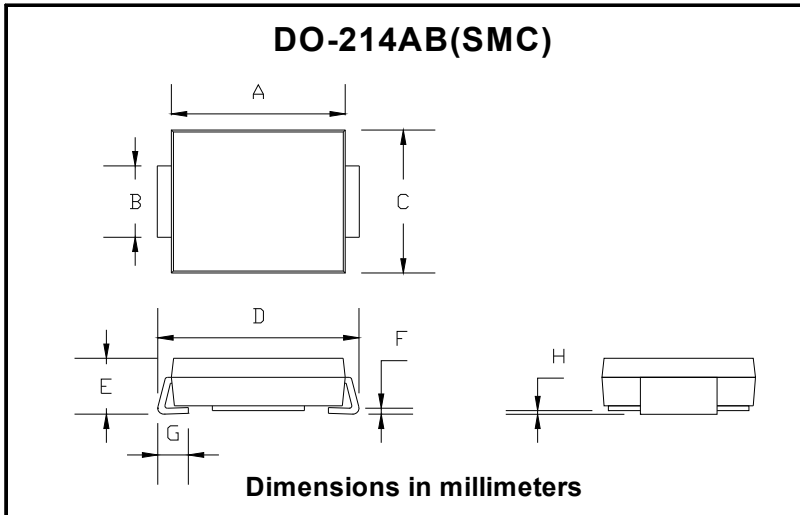

FIG.5: Diagram of circuit and Testing wave form of reverse recovery time



## ■ Outline Dimensions



DO-214AB (SMC)		
Dim	Min	Max
A	6.60	7.11
B	2.85	3.27
C	5.59	6.22
D	7.75	8.13
E	1.99	2.61
F	0.15	0.31
G	0.76	1.52
H	0.10	0.20

## ■ Suggested pad layout

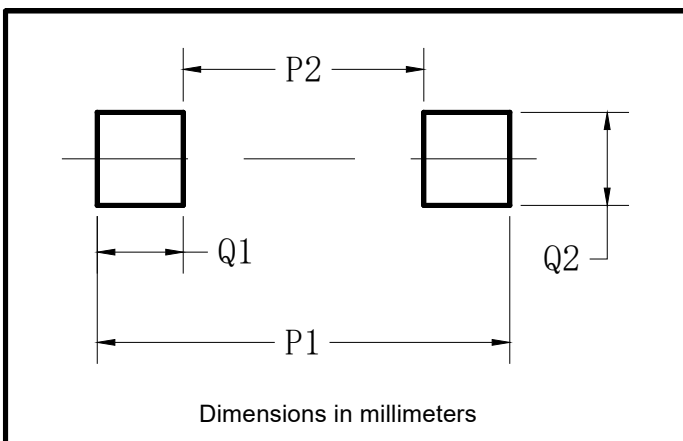

Dim	Typ
P1	9.9
P2	3.84
Q1	3.03
Q2	3.82



## MURS320

---

### Disclaimer

The information presented in this document is for reference only. Yangzhou Yangjie Electronic Technology Co., Ltd. reserves the right to make changes without notice for the specification of the products displayed herein to improve reliability, function or design or otherwise.

The product listed herein is designed to be used with ordinary electronic equipment or devices, and not designed to be used with equipment or devices which require high level of reliability and the malfunction of which would directly endanger human life (such as medical instruments, transportation equipment, aerospace machinery, nuclear-reactor controllers, fuel controllers and other safety devices), Yangjie or anyone on its behalf, assumes no responsibility or liability for any damages resulting from such improper use of sale.

This publication supersedes & replaces all information previously supplied. For additional information, please visit our website [http:// www.21yangjie.com](http://www.21yangjie.com) , or consult your nearest Yangjie's sales office for further assistance.