

Description

The P9221-R-EVK Mass-Market Evaluation Board demonstrates the features and performance of the P9221-R 15W Wireless Power Receiver (Rx). It is intended to evaluate the functionality and performance of P9221-R. The P9221-R-EVK offers the flexibility to program parameters, such as output voltage, over current limit threshold, and external temperature sensing function. It also enables tuning the Foreign Object Detection (FOD) by connecting the center tap of the on-board resistor dividers to each of these pins. The printed circuit board (PCB) has four layers. The P9221-R Evaluation Board is designed to function with the P9242-R Transmitter Evaluation Board, which is ordered separately. It can also be used with the user's WPC-1.2.2 compliant transmitter.

The high-efficiency, turnkey reference design is supported by comprehensive online, digital resources to significantly expedite design-in effort and enable rapid prototyping. The total active area is optimized to 28 mm x 15 mm.

P9221-R-EVK Mass-Market Evaluation Board

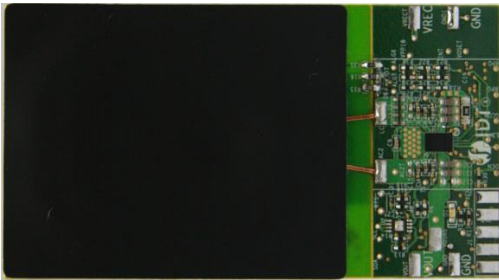

Features

- P9221-R evaluation board with support for WPC-1.2.2
- Up to 15W output power
- Selectable output voltage: 12V or 9V
- Adjustable over-current limit
- External FOD tuning
- Power transfer LED indicator
- Alignment guide information using the PCB coils
- 4-layer PCB
- Total active area: 420 mm²
- Fully assembled with test points and coil fixture

Kit Contents

- P9221-R-EVK Mass-Market Evaluation Board

P9221-R-EVK Connected to P9242-R Transmitter Board

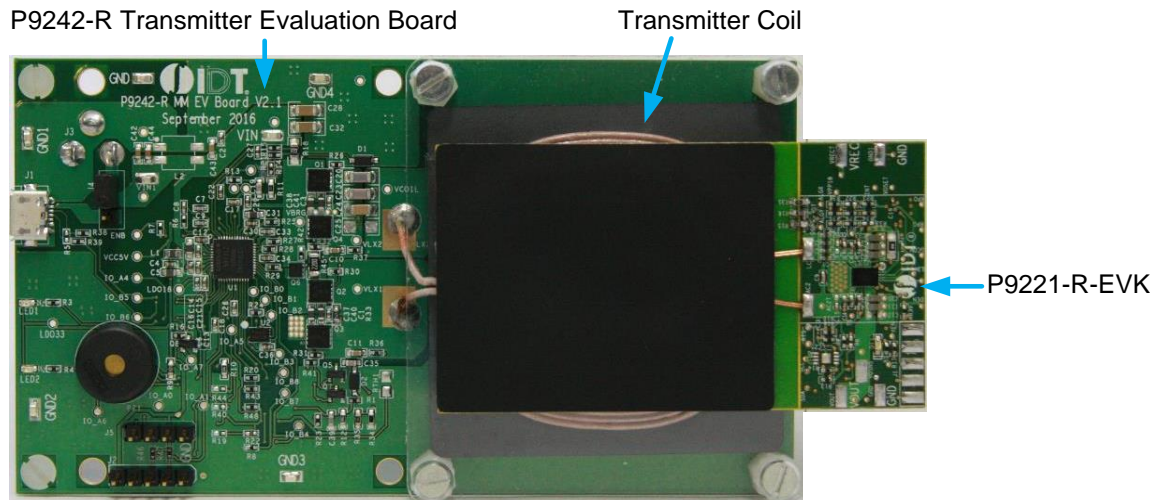

Important Notes

Disclaimer

Integrated Device Technology, Inc. and its affiliated companies (herein referred to as “IDT”) shall not be liable for any damages arising out of defects resulting from

- (i) delivered hardware or software
- (ii) non-observance of instructions contained in this manual and in any other documentation provided to user, or
- (iii) misuse, abuse, use under abnormal conditions, or alteration by anyone other than IDT.

TO THE EXTENT PERMITTED BY LAW, IDT HEREBY EXPRESSLY DISCLAIMS AND USER EXPRESSLY WAIVES ANY AND ALL WARRANTIES, WHETHER EXPRESS, IMPLIED, OR STATUTORY, INCLUDING, WITHOUT LIMITATION, IMPLIED WARRANTIES OF MERCHANTABILITY AND OF FITNESS FOR A PARTICULAR PURPOSE, STATUTORY WARRANTY OF NON-INFRINGEMENT, AND ANY OTHER WARRANTY THAT MAY ARISE BY REASON OF USAGE OF TRADE, CUSTOM, OR COURSE OF DEALING.

Restrictions in Use

IDT’s P9221-R-EVK Mass Market Evaluation Board is designed for evaluation purposes only. It must not be used for module production or production test setups.

Contents

1. Setup	4
1.1 Required or Recommended User Equipment.....	4
1.2 Kit Hardware Connections	4
2. Usage Guide.....	5
2.1 Overview of the P9221-R-EVK	5
2.2 VOUT (Output Voltage) Modification	5
2.3 Alignment Aid – ALIGNX and ALIGNY	6
2.4 Adjustment of Over-Current Limit	8
2.5 External Temperature Sensing – TS	9
2.6 Receiver Coil	9
3. Schematics, Bill of Materials (BOM), and Board Layout.....	10
3.1 P9221-R Evaluation Board Schematics.....	10
4. Bill of Materials (BOM).....	11
5. Board Layout	12
6. Ordering Information.....	15
7. Revision History.....	15

List of Figures

Figure 1. Evaluation Kit Connections using the P9242-R Transmitter Evaluation Board	4
Figure 2. P9221-R V2.1 Evaluation Board Features.....	5
Figure 3. R33 and R34 PCB Location	6
Figure 4. Recommended Structure of the X-Y Alignment Coil.....	7
Figure 5. R38 and R22 PCB Location	8
Figure 6. Over-Current Limit vs. ILIM Pin Voltage	8
Figure 7. Optional External Temperature Sensing by Connecting an RTS Thermistor	9
Figure 8. Silkscreen – Top of Board	12
Figure 9. Silkscreen – Bottom of Board	12
Figure 10. Copper – Top Layer.....	13
Figure 11. Copper L2 Layer.....	13
Figure 12. Copper L3 Layer.....	14
Figure 13. Copper Bottom	14

List of Tables

Table 1. Setting the Output Voltage	5
Table 2. Recommend Coil Manufacturer.....	9
Table 3. Application Board BOM	11

1. Setup

1.1 Required or Recommended User Equipment

The following additional lab equipment is required for using the kit:

- P9242-R Transmitter Evaluation Board or any WPC-1.2.2 compliant transmitter.
- Power supply or 12V/2A AC adaptor

1.2 Kit Hardware Connections

Follow these procedures to set up the kit as shown in Figure 1.

1. Set up the P9242-R Evaluation Board (or user transmitter) according to the board's user manual
2. Place the P9221-R-EVK on the transmitter (TX) pad with the components facing up as shown in Figure 1.
3. Verify that the green LED is illuminated – coupling has been established.
4. Connect wires to the VOUT and GND test points to measure output voltage and apply a load.

Figure 1. Evaluation Kit Connections using the P9242-R Transmitter Evaluation Board

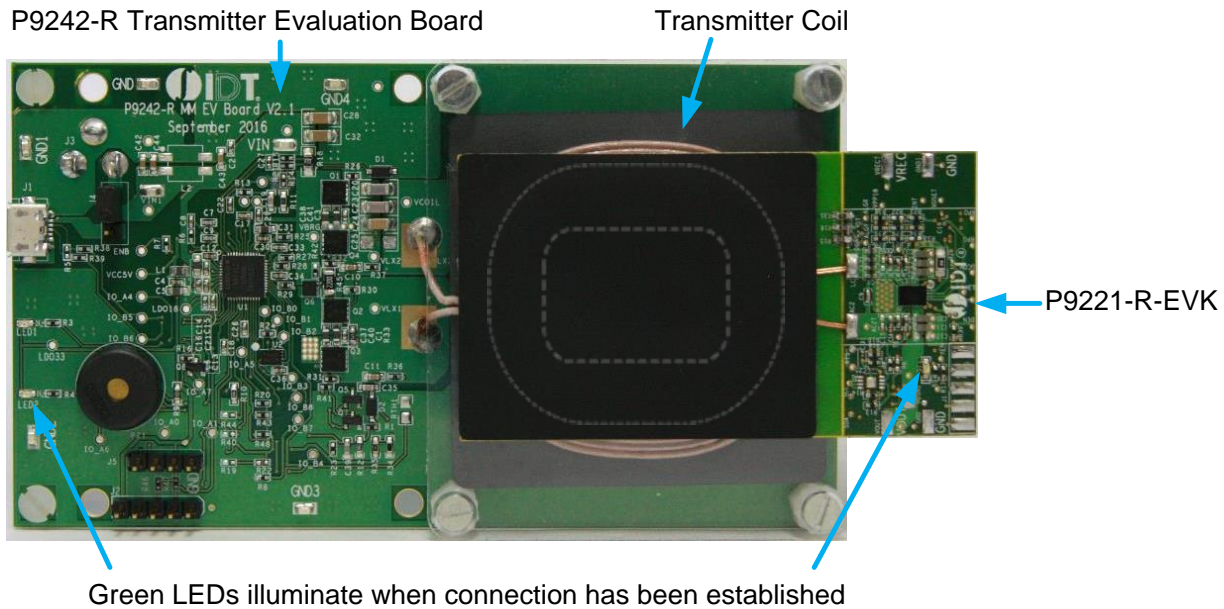

2. Usage Guide

2.1 Overview of the P9221-R-EVK

Figure 2. P9221-R V2.1 Evaluation Board Features

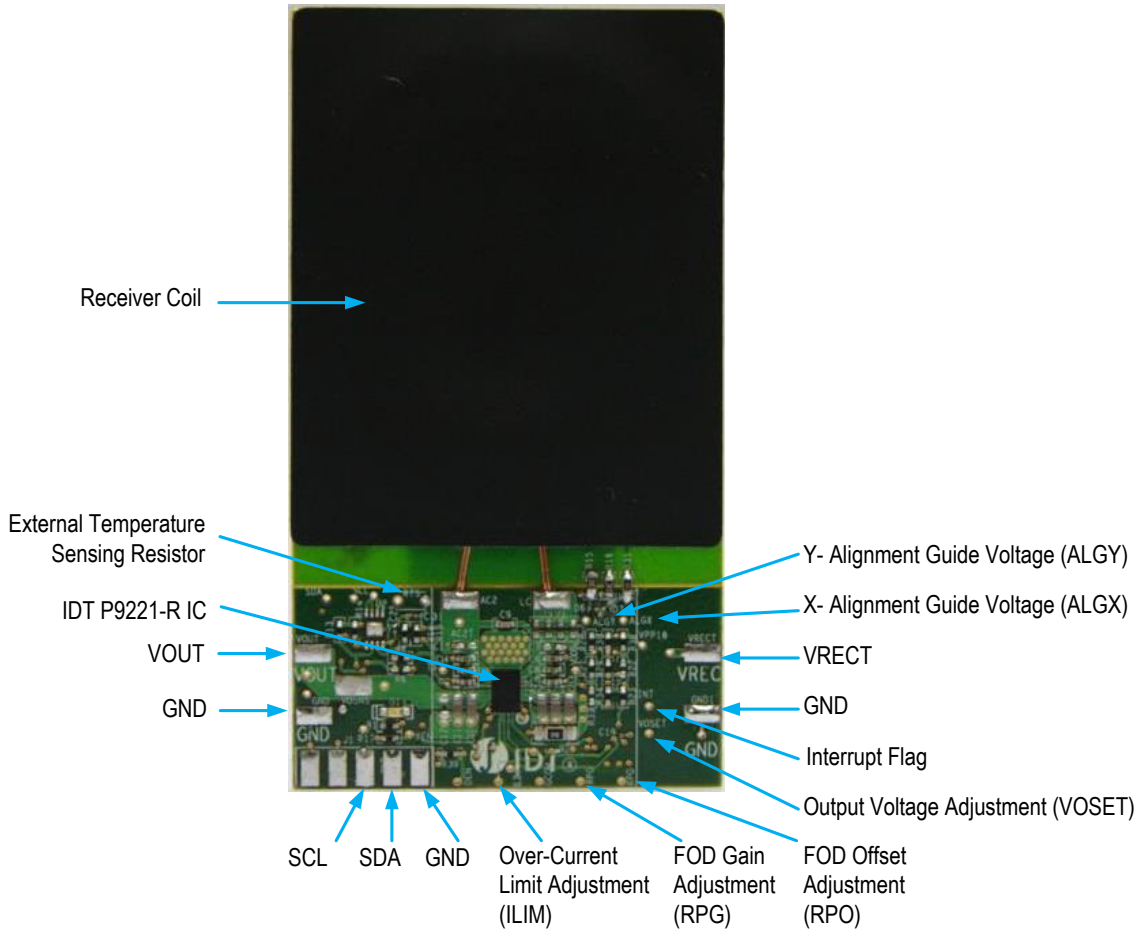

2.2 VOUT (Output Voltage) Modification

The P9221-R output voltage can be set to 9V or 12V by changing the R34 or R33 resistors value; see Table 1. The default output voltage is set to 12V. For applications where the transmitter is capable of delivering only 5W, the P9221-R will automatically switch to 5V to ensure 5W power delivery. The 5W option can be disabled by adding R33.

Table 1. Setting the Output Voltage

R34 (kΩ)	R33 (kΩ)	Output Voltage (V)	5V Output option
10	Open	12 (Default)	Enable
10	30	12	Disable
OPEN	10	9	Enable
10	3.3	9	Disable

Figure 3. R33 and R34 PCB Location

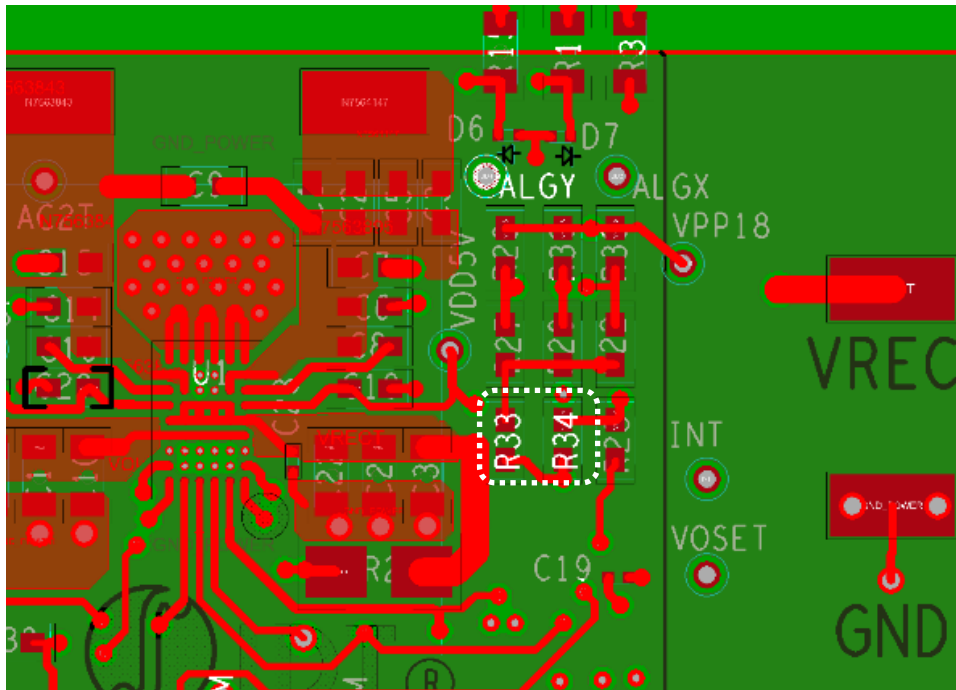

2.3 Alignment Aid – ALIGNX and ALIGNY

The signal magnitude on the P9221-R’s ALIGNX and ALIGNY pins provides directional alignment information by measuring the phase between the input power AC signal and the horizontal (ALIGNX) and vertical (ALIGNY) alignment signals. Once the signal is measured in the analog-to-digital converter, the alignment information is represented by two 8-bit signed numbers, which can be read via the I²C interface from the *Align_X* and *Align_Y* registers (see the *P9221-R Datasheet*).

The difference in the electromotive force (EMF) voltage of the two coils can be represented by the amount of magnetic flux, which depends on the misalignment position of the receiver coil relative to the transmitter coil. With the combination of two symmetrical coils on the vertical (Y) axis and horizontal (X) axis, it is possible to sense alignment in two dimensions as shown in Figure 4. The trace length and width were designed with 452.12mm and 0.254mm respectively for each segment coil on the P9221-R Evaluation Board, which was assembled with the AMOTECH ASC-504060E00-S00 coil as shown in Figure 4.

Figure 4. Recommended Structure of the X-Y Alignment Coil

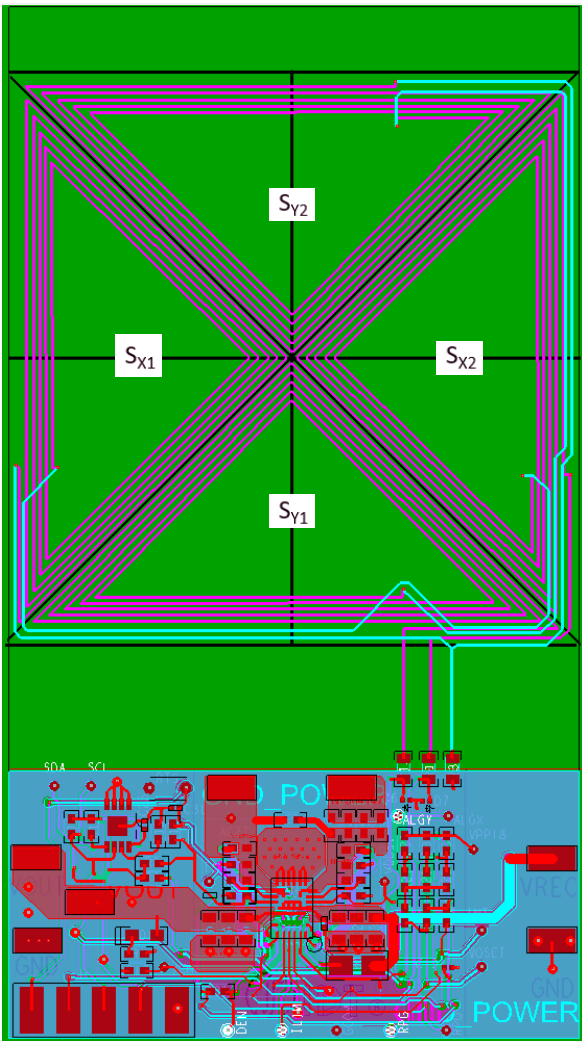

2.4 Adjustment of Over-Current Limit

The P9221-R includes the programmable current limit feature for protecting the device in the event of an over-current or short-circuit fault condition. If the output current exceeds the programmed threshold, the P9221-R will limit the load current by reducing the output voltage. The current limit should be set to 130% of the maximum output current by setting the voltage on the ILIM pin as shown in Figure 6 by adjusting R22 while keeping R38 as 10kΩ, which is connected to the 1.8V supply. The default value for the over-current limit is set to 1.6A.

Figure 5. R38 and R22 PCB Location

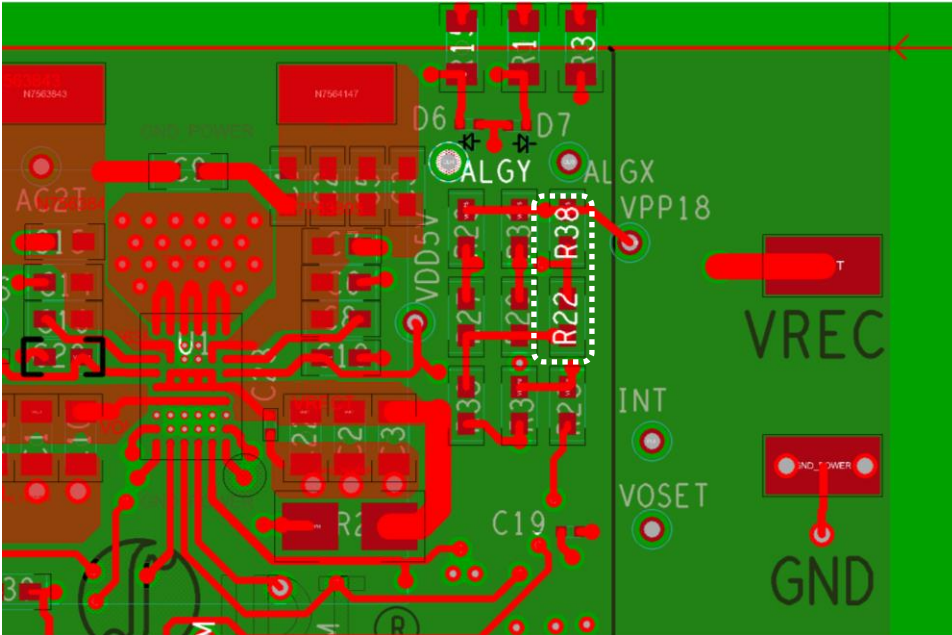
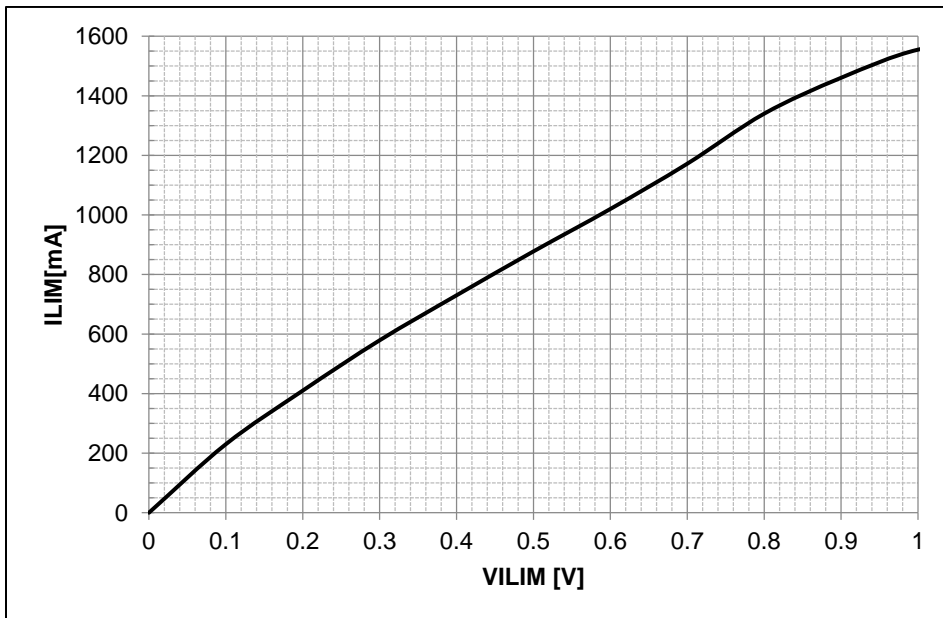

Figure 6. Over-Current Limit vs. ILIM Pin Voltage



2.5 External Temperature Sensing – TS

The P9221-R includes an optional temperature sense input pin, TS, used to monitor a remote temperature, such as for a coil or a battery charger.

The TS pin voltage can be calculated by Equation 1.

$$V_{TS} = V_{VDD18} \times \frac{NTC}{R19 + NTC} \tag{Equation 1}$$

Where NTC is the thermistor’s resistance and R19 is the pull-up resistor connected to the 1.8V supply voltage on the P9221-R Evaluation Board. The over-temperature shutdown is triggered if the voltage on the TS pin is lower than 0.6V. The RTS is not populated on the P9221-R Evaluation Board.

Figure 7. Optional External Temperature Sensing by Connecting an RTS Thermistor

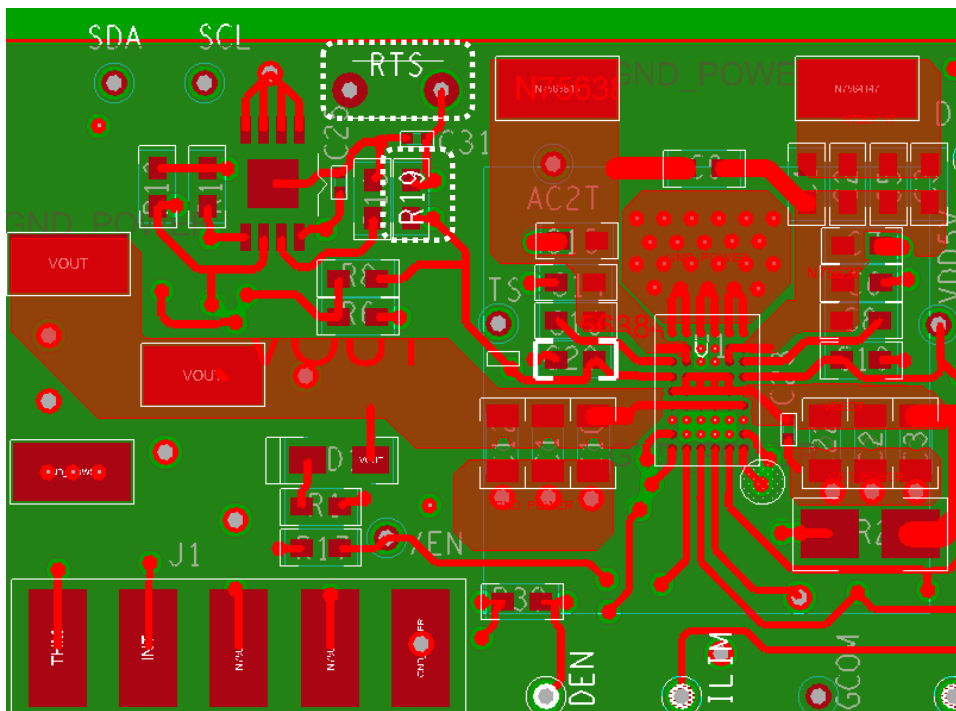

2.6 Receiver Coil

The following coil is recommended with P9221-R receiver for 15W applications for optimum performance. The recommended vendor has been tested and verified.

Table 2. Recommend Coil Manufacturer

Output Power	Vendor	Part number	Inductance at 100kHz	ACR at 20°C
15W	AMOTECH	ASC-504060M22-S00	8.2µH	220mΩ

3. Schematics, Bill of Materials (BOM), and Board Layout

3.1 P9221-R Evaluation Board Schematics

P9221-R MM EV Board V2.1

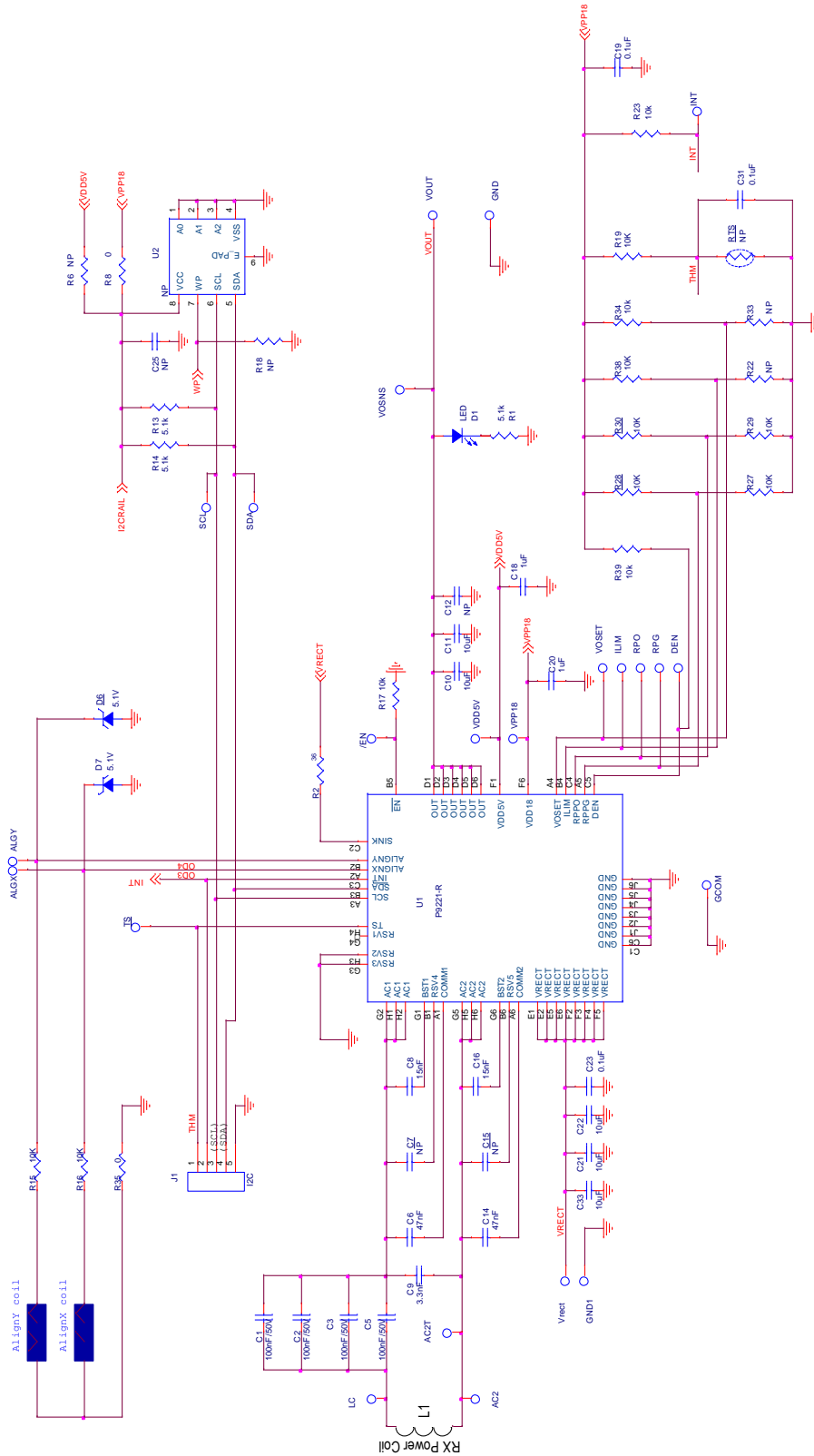

4. Bill of Materials (BOM)

Table 3. Application Board BOM

Item	Reference	Quantity	Value	Description	Part Number	PCB Footprint
1	AC2T, VDD5V, VPP18, VOSET, TS, SDA, SCL, RPO, RPG, INT, ILIM, GCOM, DEN, ALGY, ALGX, IEN	16	PTH_TP	Test Pad		10MIL_35PAD
2	AC2, LC	2	NP	Test Point		test_pt_sm_135x70
3	C1, C2, C3, C5	4	100nF/50V	CAP CER 0.1UF 50V X5R 0402	GRM155R61H104KE19D	402
4	C6, C14	2	47nF	CAP CER 0.047UF 50V X7R 0402	C1005X7R1H473K050BB	402
5	C7, C15	2	NP	CAP CER 0.047UF 50V X7R 0402	C1005X7R1H473K050BB	402
6	C8, C16	2	15nF	CAP CER 0.015UF 50V X7R 0402	GRM155R71H153KA12J	402
7	C9	1	3.3nF	CAP CER 3300PF 50V X7R 0402	CL05B332KB5NNNC	402
8	C10, C11, C21, C22, C33	5	10uF	CAP CER 10UF 25V X5R 0603	CL10A106MA8NRNC	603
9	C12	1	NP	CAP CER 10UF 25V X5R 0603	CL10A106MA8NRNC	603
10	C18	1	NP	CAP CER 1UF 10V X5R 0402	GRM155R61A105KE15D	402
11	C20	1	1uF	CAP CER 1UF 10V X5R 0402	GRM155R61A105KE15D	402
12	C19, C25, C31	3	0.1uF	CAP CER 0.1UF 10V X5R 0201	C0603X5R1A104K030BC	201
13	C23	1	0.1uF	CAP CER 0.1UF 25V X5R 0201	CL03A104KA3NNNC	201
14	D1	1	LED	LED GREEN CLEAR 0603 SMD	150060GS75000	0603_diode
15	D6,D7	2	5.1V	DIODE ZENER 5.1V 100MW 0201	CZRZ5V1B-HF	201
16	GND1, VRECT, VOUT, VOSNS, GND	5	Test Point	TEST POINT PC MINIATURE SMT	5015	test_pt_sm_135x70
17	L1	1	RX coil	AMOTECH, Rx Power Coil	ASC-504060M22-S00	10MIL_35PAD
18	J1	1	NP	HEADER_1X5_0P1PITCH60P42D	68002-205HLF	header_1x5_0p1Pitch60p42d
19	RTS	1	NP			NTC2
20	R1, R13, R14	3	5.1k	RES SMD 5.1K OHM 5% 1/16W 0402	MCR01MRTJ512	402
21	R2	1	36	RES SMD 36 OHM 5% 1/2W 0805	ERJ-P06J360V	805
22	R6	1	NP	RES SMD 0.0OHM 1/10W 0402	ERJ-2GE0R00X	402
23	R8	1	0	RES SMD 0.0OHM 1/10W 0402	ERJ-2GE0R00X	402
24	R15, R16	2	10K	RES SMD 10KOHM 1% 1/10W 0603	RC0603FR-0710KL	603
25	R17, R19, R23, R27, R28, R29, R30, R34, R38, R39	10	10k	RES SMD 10K OHM 5% 1/10W 0402	ERJ-2GEJ103X	402
26	R18, R22, R33	3	NP	RES SMD 10K OHM 5% 1/10W 0402	ERJ-2GEJ103X	402
27	R35	1	0	RES SMD 0.0OHM JUMPER 1/10W 0603	MCR03EZPJ000	603
28	U1	1	P9221-R	Wireless power receiver	P9221-R	csp52_2p64x3p94_0p4mm
29	U2	1	NP	IC EEPROM 128KBIT 400KHZ 8TDFN	24AA128T-I/MNY	TDFN08

5. Board Layout

Figure 8. Silkscreen – Top of Board

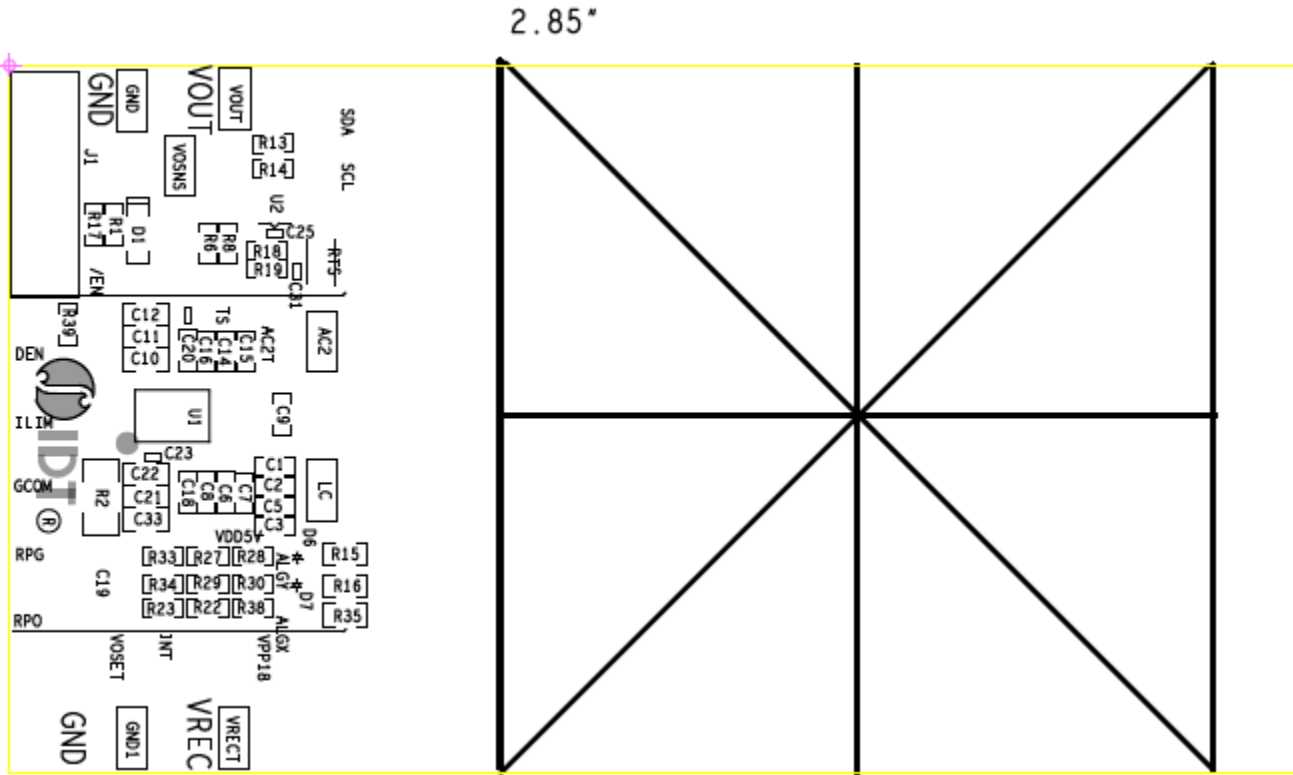

Figure 9. Silkscreen – Bottom of Board

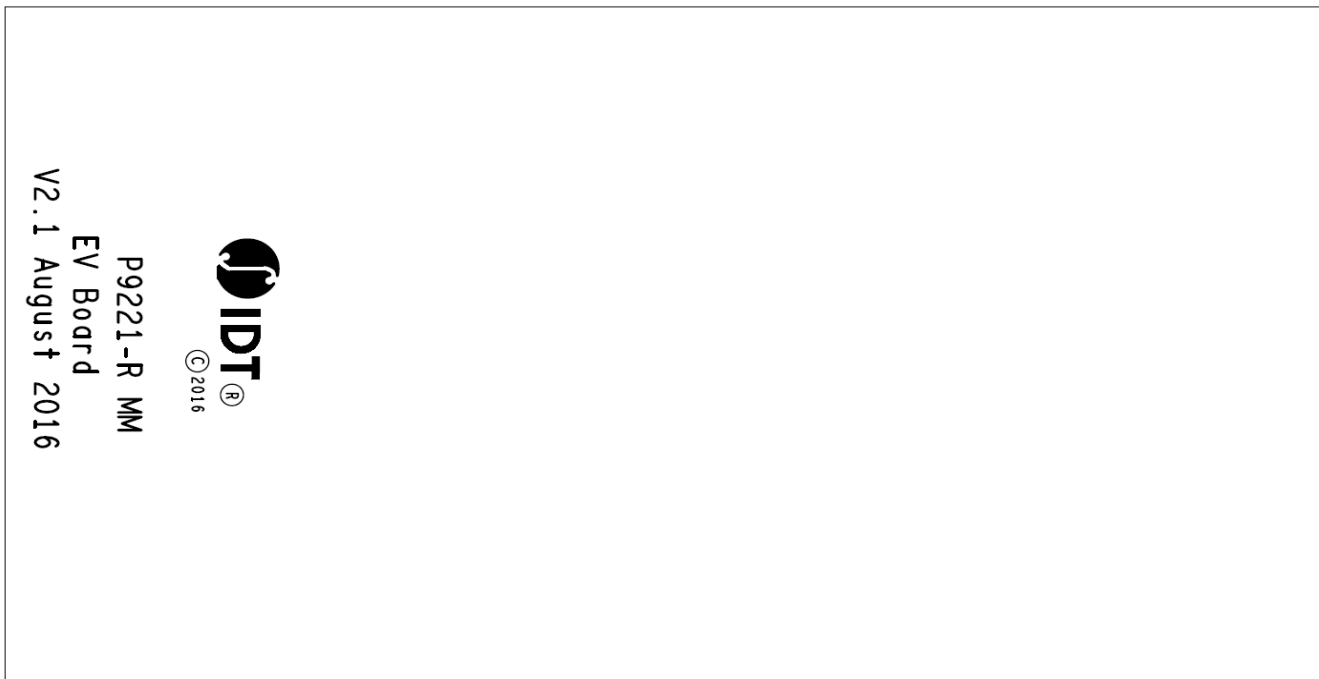

Figure 10. Copper – Top Layer

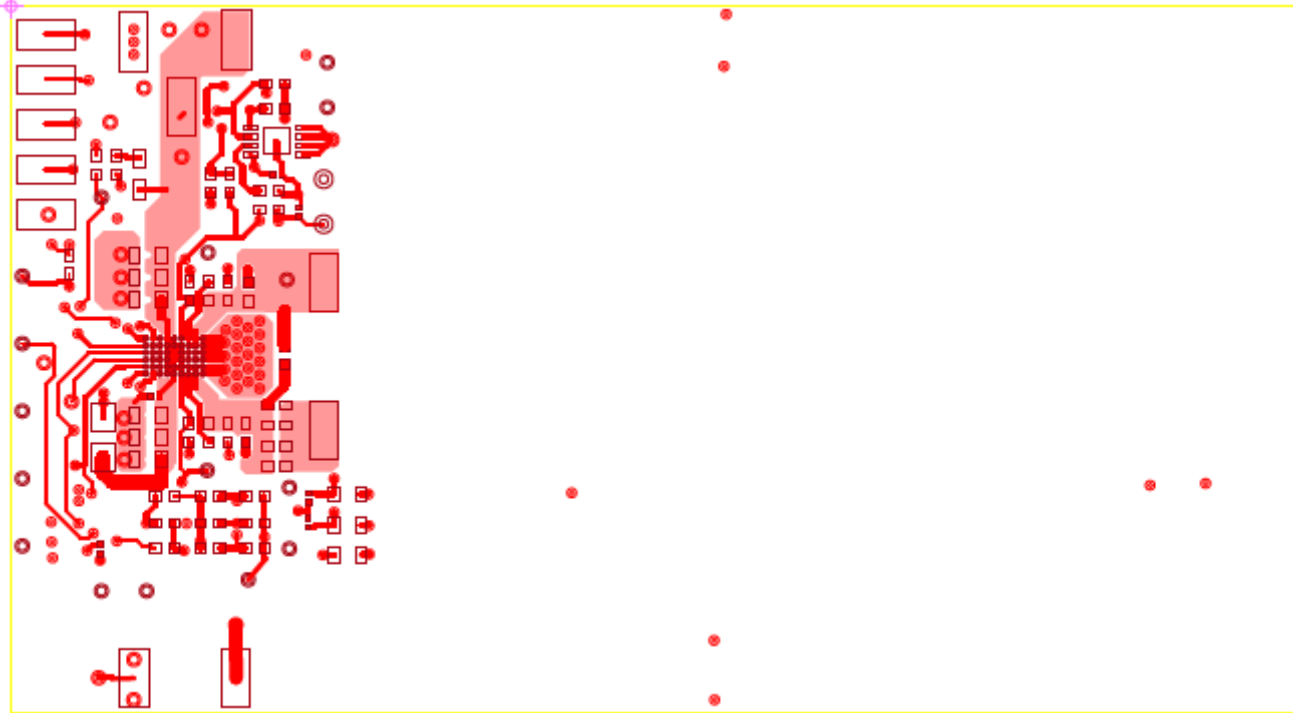

Figure 11. Copper L2 Layer

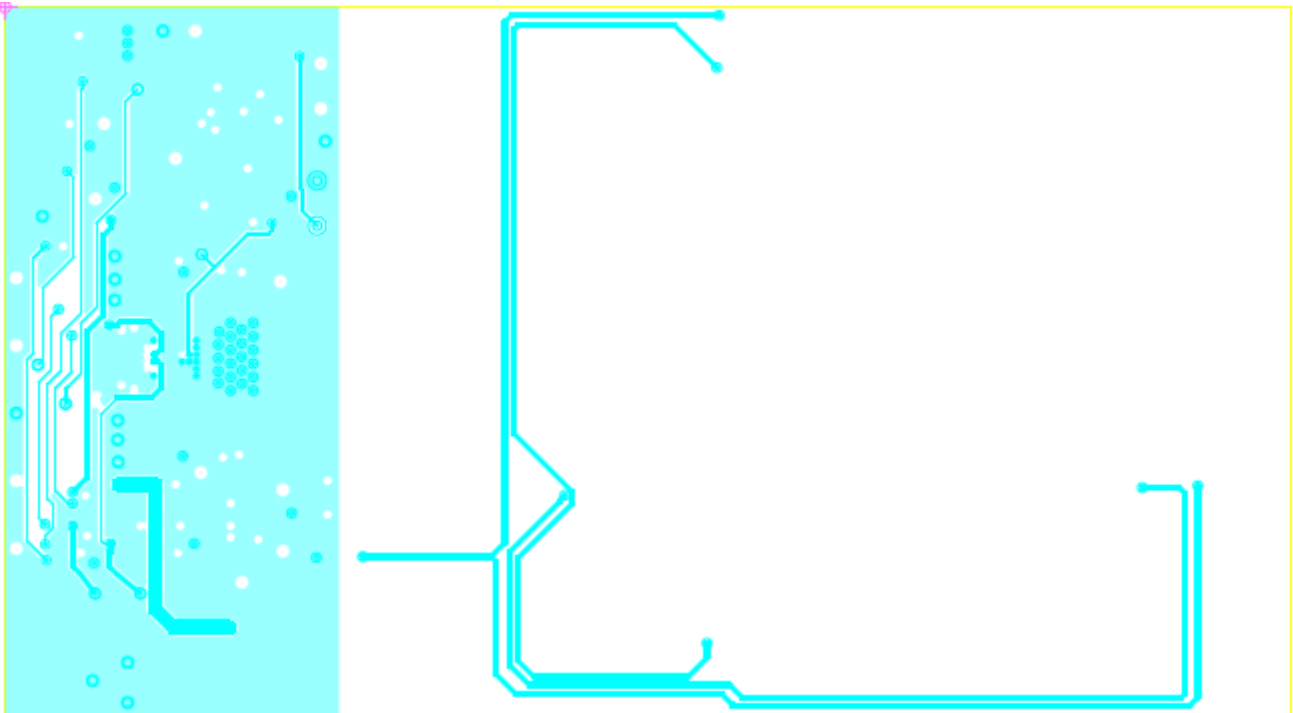

Figure 12. Copper L3 Layer

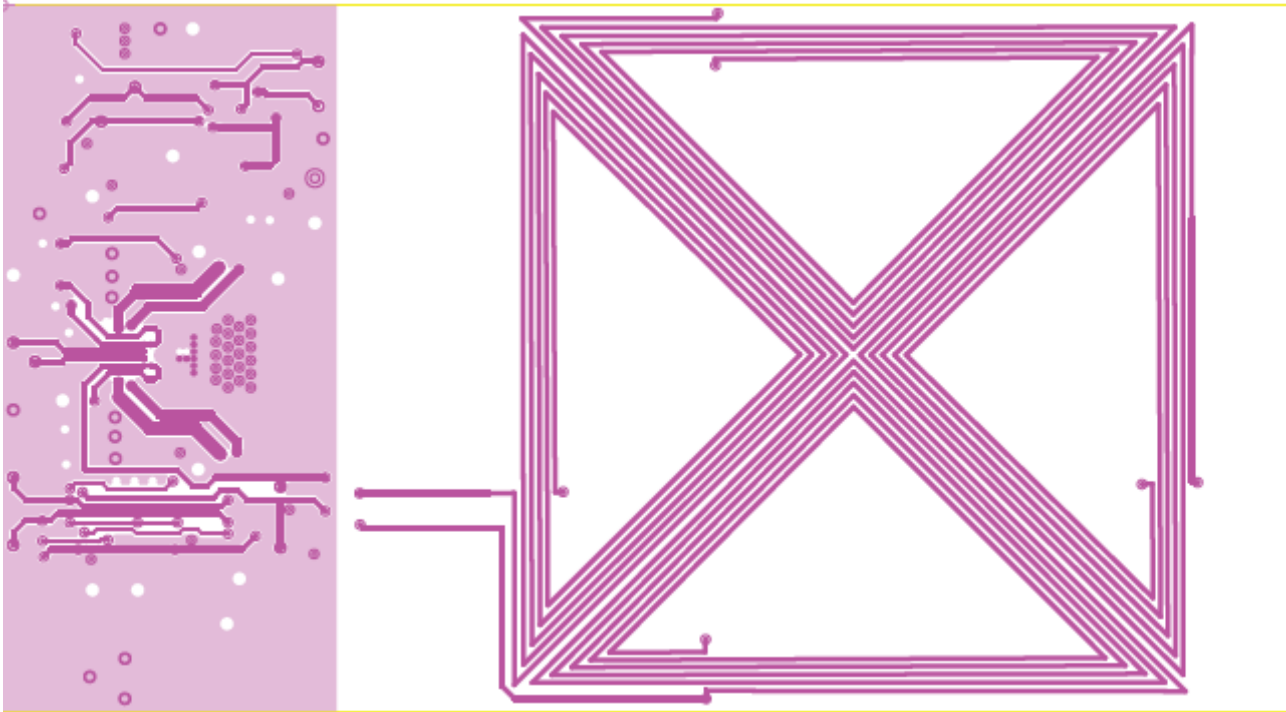
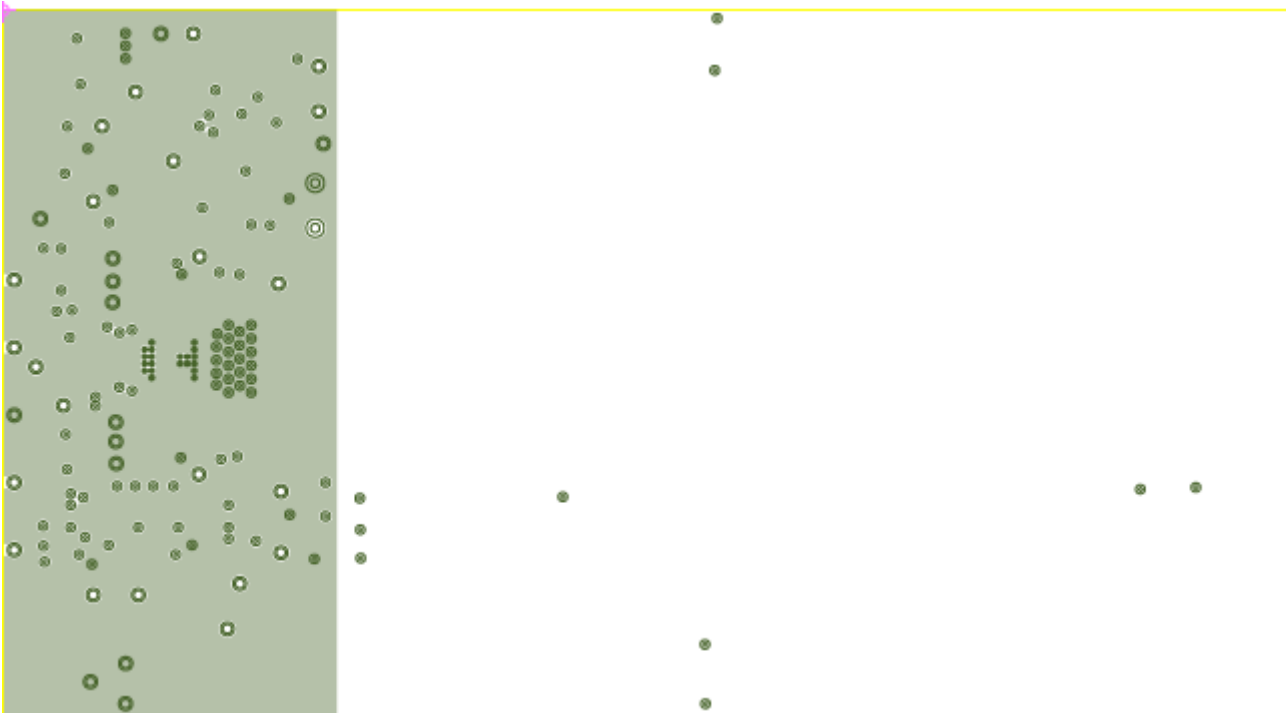

Figure 13. Copper Bottom



6. Ordering Information

Orderable Part Number	Description
P9221-R-EVK	P9221-R-EVK Evaluation Board

7. Revision History

Revision Date	Description of Change
December 19, 2016	Initial release of document.