

60V N-Channel MOSFET

■ Features

- $V_{DS} (V) = 60V$
- $I_D = 3A$
- $R_{DS(ON)} < 80m\Omega (V_{GS} = 10V)$
- $R_{DS(ON)} < 95m\Omega (V_{GS} = 4.5V)$

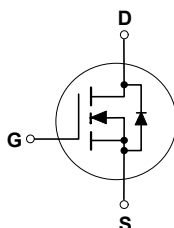
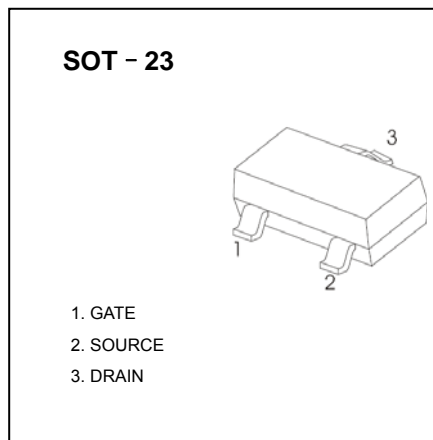

■ Absolute Maximum Ratings $T_a = 25^\circ C$

Parameter	Symbol	Rating	Unit
Drain-Source Voltage	V_{DS}	60	V
Gate-Source Voltage	V_{GS}	± 20	V
Continuous Drain Current	I_D	$T_A = 25^\circ C$	A
		$T_A = 70^\circ C$	
Pulsed Drain Current *	I_{DM}	10	
Power Dissipation	P_D	1.38	W
Linear Derating Factor		0.01	W/ $^\circ C$
Thermal Resistance Junction-to-ambient	R_{thJa}	90	$^\circ C/W$
Junction and Storage Temperature Range	T_J, T_{STG}	-55 to 150	$^\circ C$

* 2. Pulse width $\leq 300\mu s$, duty cycle $\leq 2\%$.

■ Electrical Characteristics Ta = 25°C

Parameter	Symbol	Testconditons	Min	Typ	Max	Unit
Drain-Source Breakdown Voltage	V _{DSS}	I _D =250μA, V _{GS} =0V	60			V
Zero Gate Voltage Drain Current	I _{DSS}	V _{DS} =60V, V _{GS} =0V			10	μA
		V _{DS} =48, V _{GS} =0V, T _J =70°C			25	
Gate-Body leakage current	I _{GSS}	V _{DS} =0V, V _{GS} =±20V			±100	nA
Gate Threshold Voltage	V _{GS(th)}	V _{DS} =V _{GS} I _D =-250μA	1		3	V
Static Drain-Source On-Resistance	R _{DSON}	V _{GS} =10V, I _D =3A			80	mΩ
		V _{GS} =4.5V, I _D =2A			95	
Forward Transconductance	g _{FS}	V _{DS} =5V, I _D =3A		5		S
Input Capacitance	C _{iss}	V _{GS} =0V, V _{DS} =25V, f=1MHz		490	780	pF
Output Capacitance	C _{oss}			55		
Reverse Transfer Capacitance	C _{rss}			40		
Total Gate Charge	Q _g	V _{DS} =48V, I _D =3A, V _{GS} =4.5V		6	10	nC
Gate Source Charge	Q _{gs}			1.6		
Gate Drain Charge	Q _{gd}			3		
Turn-On DelayTime	t _{D(on)}	V _{GS} =10V, V _{DS} =30V, I _D =1A RD=30Ω, R _{GEN} =3.3Ω		6		ns
Turn-On Rise Time	t _r			5		
Turn-Off DelayTime	t _{D(off)}			16		
Turn-Off Fall Time	t _f			3		
Body Diode Reverse Recovery Time	t _{rr}	I _S =3A, di/dt=100A/μs		25		
Body Diode Reverse Recovery Charge	Q _{rr}	I _S =3A, di/dt=100A/μs		26		nC
Diode Forward Voltage	V _{SD}	I _S =1.2A, V _{GS} =0V			1.2	V

60V N-Channel MOSFET

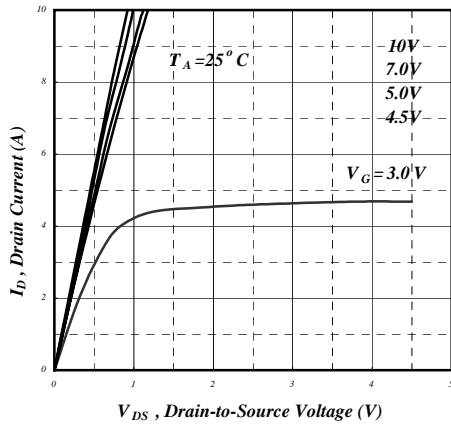

Fig 1. Typical Output Characteristics

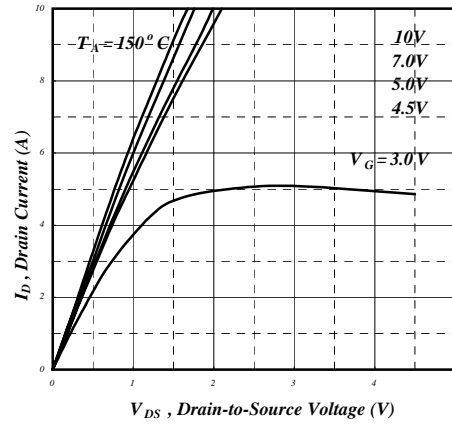

Fig 2. Typical Output Characteristics

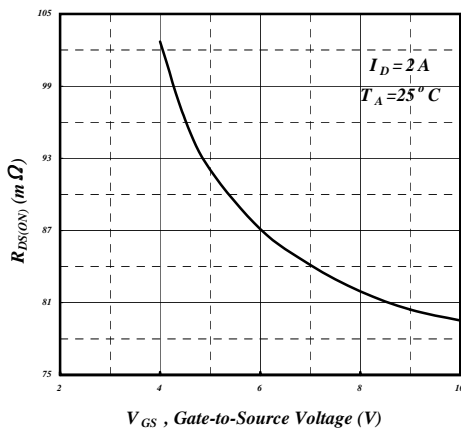

Fig 3. On-Resistance v.s. Gate Voltage

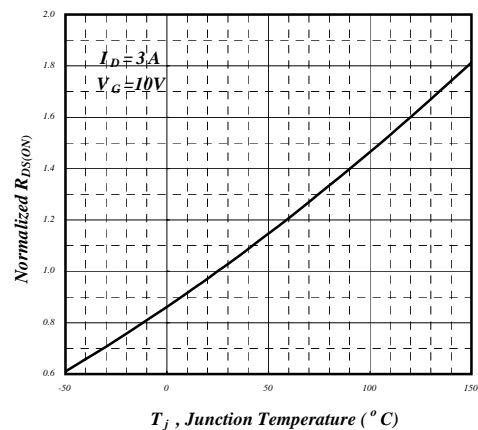

Fig 4. Normalized On-Resistance v.s. Junction Temperature

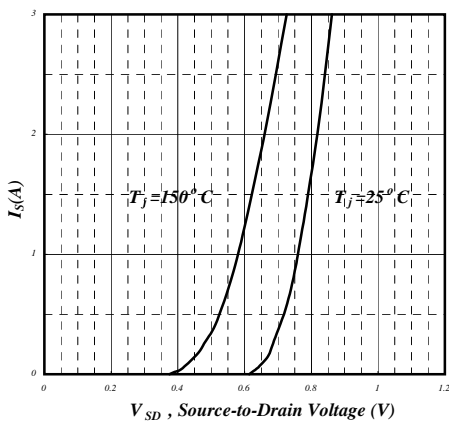

Fig 5. Forward Characteristic of Reverse Diode

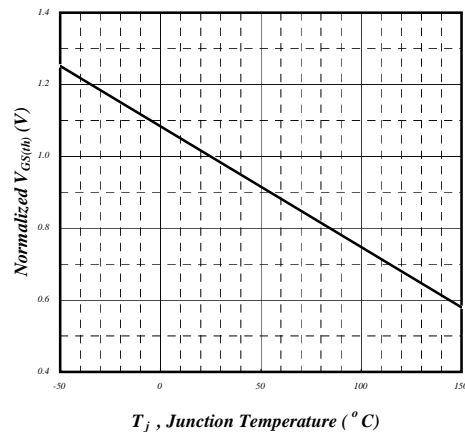

Fig 6. Gate Threshold Voltage v.s. Junction Temperature

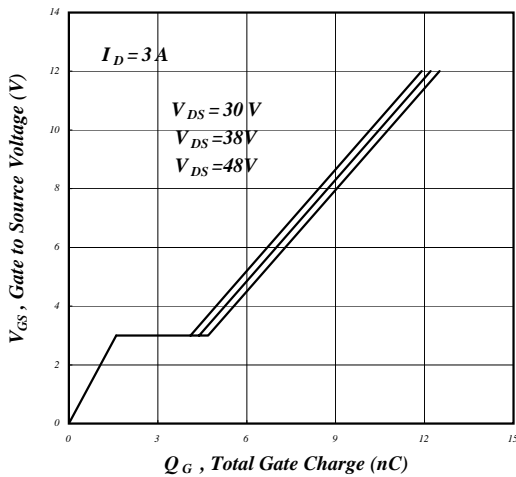

Fig 7. Gate Charge Characteristics

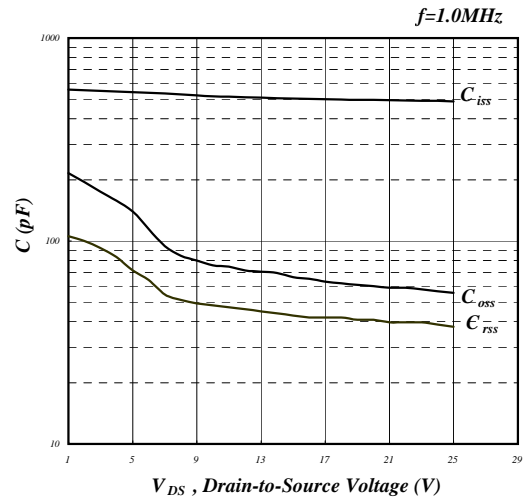

Fig 8. Typical Capacitance Characteristics

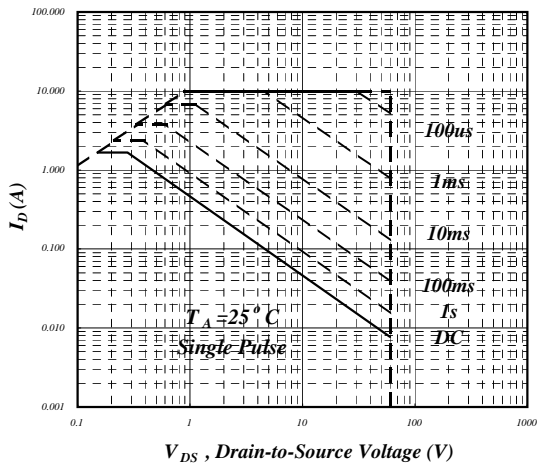

Fig 9. Maximum Safe Operating Area

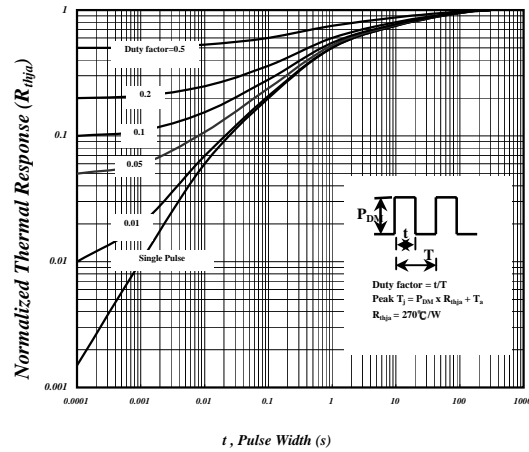
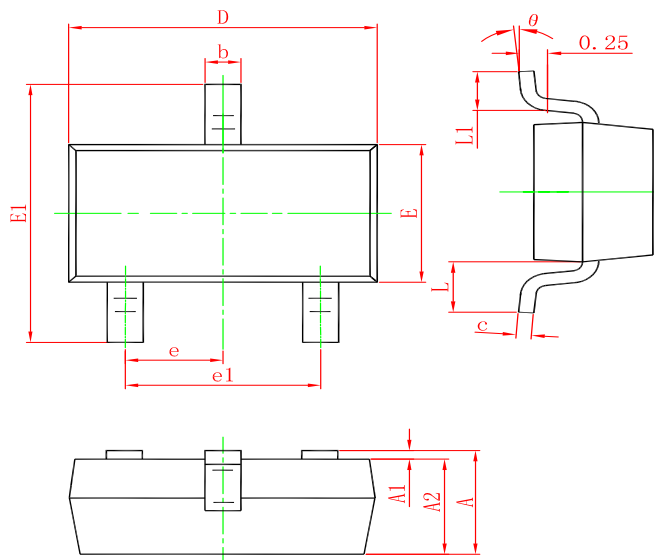

Fig 10. Effective Transient Thermal Impedance

SOT-23 PACKAGE OUTLINE DIMENSIONS



Symbol	Dimensions In Millimeters		Dimensions In Inches	
	Min.	Max.	Min.	Max.
A	0.900	1.150	0.035	0.045
A1	0.000	0.100	0.000	0.004
A2	0.900	1.050	0.035	0.041
b	0.300	0.500	0.012	0.020
c	0.080	0.150	0.003	0.006
D	2.800	3.000	0.110	0.118
E	1.200	1.400	0.047	0.055
E1	2.250	2.550	0.089	0.100
e	0.950 TYP.		0.037 TYP.	
e1	1.800	2.000	0.071	0.079
L	0.550 REF.		0.022 REF.	
L1	0.300	0.500	0.012	0.020
θ	0°	8°	0°	8°

Marking

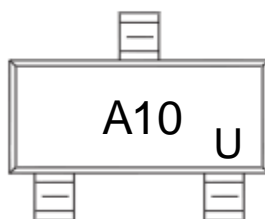

Ordering information

Order code	Package	Baseqty	Deliverymode
UMW SI2310A	SOT-23	3000	Tape and reel