

Parameters Subject to Change Without Notice

FEATURES

- 2.5V to 6V operating input range
- Up to 2A output current
- Up to 94% peak efficiency
- High efficiency (>85%) at light load
- Internal Soft-Start
- 1.5MHz switching frequency
- Input under voltage lockout
- Short circuit protection
- Thermal protection
- Hot-plug in protection
- Output POK indication (available in SOT23-6 package)
- Available in SOT23-5/SOT23-6 package

APPLICATIONS

- 5V or 3.3V Point of Load Conversion
- Set Top Boxes
- Telecom/Networking Systems
- Storage Equipment
- GPU/DDR Power Supply

DESCRIPTION

The JW[®]5223 is a current mode monolithic buck switching regulator. Operating with an input range of 2.5V-6V, the JW5223 delivers 1.2A of continuous output current with integrated P-Channel and N-Channel MOSFETs. The internal synchronous power switches provide high efficiency. At light loads, the regulator operates in low frequency to maintain high efficiency. Current mode control provides tight load transient response and cycle-by-cycle current limit. The JW5223 guarantees robustness with hiccup output short-circuit protection, FB short-circuit protection, current run-away protection, input under voltage lockout, hot-plug protection, and thermal protection.

ELECTRICAL SPECIFICATIONS

Parameter	Symbol	Value	Unit
Input Voltage	VIN	2.5~6	V
Output Voltage	VOUT	1.8	V
Output Current	IOUT	0~1.2	A

TYPICAL PERFORMANCE



SCHEMATIC

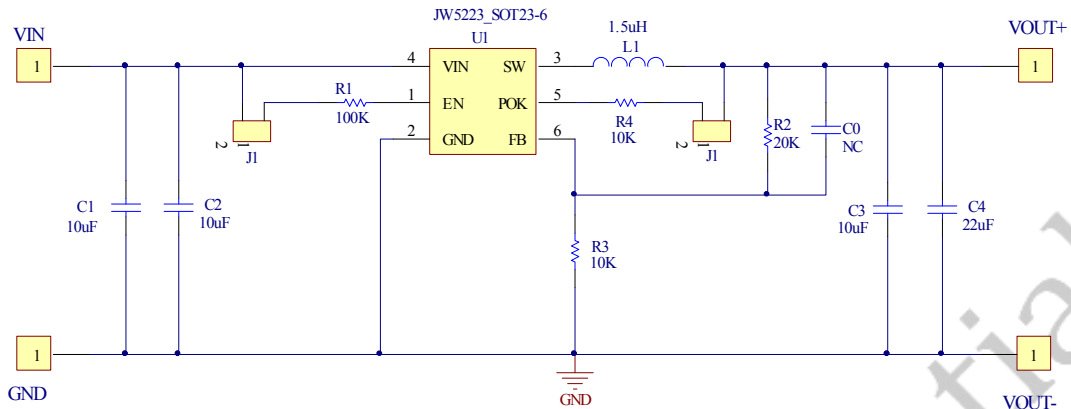

BILL OF MATERIALS

Qty	Designator	Value	Description	Package	Manufacturer	Manufacturer P/N
0	C0	NC				
2	C1,C2	10uF	Ceramic capacitor 10V ,X7R	0805C		
1	C3	22uF	Ceramic capacitor 6.3V ,X7R	0805C		
0	C4	NC				
1	L1	1.5uH/3A	Inductor		WürthElektronik	
1	R1	100k	Resistor,5%	0603R		
1	R2	20k	Resistor,1%	0603R		
1	R3	10k	Resistor,1%	0603R		
1	R4	10k	Resistor,5%	0603R		
1	VIN	2.5V~6V		TEST-Pole		
1	VOUT	1.8V/1.2A		TEST-Pole		
1	JW5223	6V/1.2A	Buck	SOT23-6	Joulwatt	JW5223

PRINTED CIRCUIT BOARD LAYEROUT

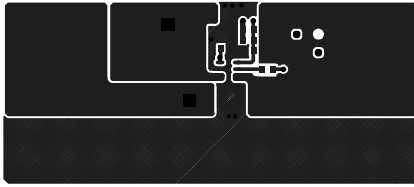

Figure1—Top Layer

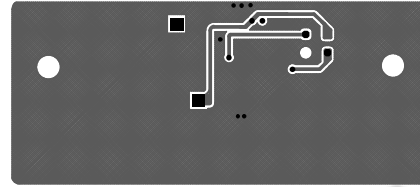

Figure2—Bottom Layer

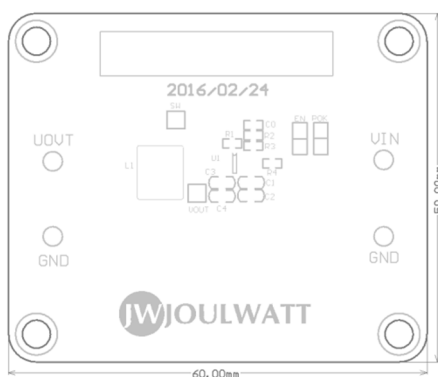

Figure3—Silk Layer

QUICK START GUIDE

1. Connect the positive terminal and negative terminal of the load to Vout and GND of EVB, respectively.
2. Connect a power supply between VIN and GND with the supply in “OFF” state. Set the output voltage of the power supply to 2.5V~6V.
3. Turn on the power supply and the evaluation board starts operating in normal condition.
4. The output voltage can be adjusted by varying the R2 and R3 on EVB.
For example: Fixed R3 to 10K, when adjusting the output voltage to 3.3V,
 $R2 = V_{out} / 0.6 * R3 - R3$.
5. For more information, please refer to the datasheet of JW5223.

TYPICAL PERFORMANCE CHARACTERISTICS

Vin = 5V, Vout = 1.8V, L = 1.5μH, Cout = 22μF, TA = +25°C, unless otherwise noted

Steady State Test

VIN=5V, Vout=1.8V
Iout=1.2A

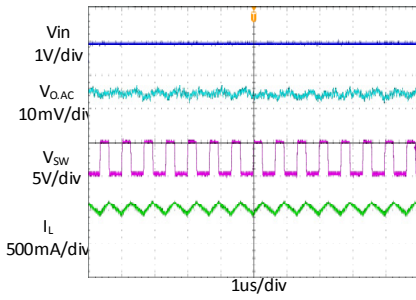

Startup through Enable

VIN=5V, Vout=1.8V
Iout=1.2A(Resistive load)

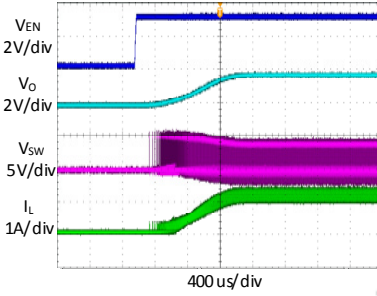

Shutdown through Enable

VIN=5V, Vout=1.8V
Iout=1.2A(Resistive load)

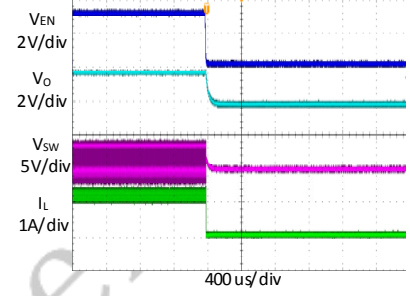

Heavy Load Operation

1.2A LOAD

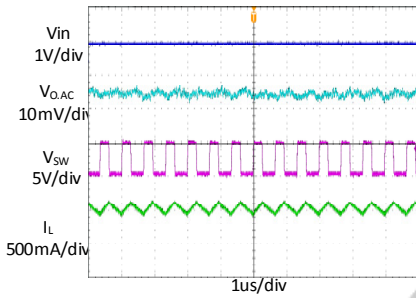

Medium Load Operation

0.6A LOAD

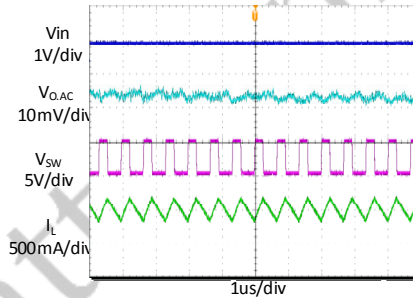

Light Load Operation

0 A LOAD

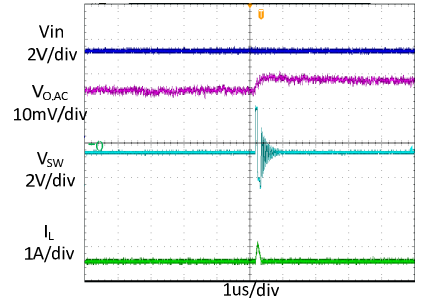

Short Circuit Protection

VIN=5V, Vout=1.8V
Iout=1.2A- Short

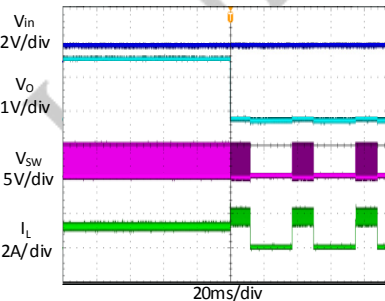

Short Circuit Protection

VIN=5V, Vout=1.8V
Iout= Short-1.2A

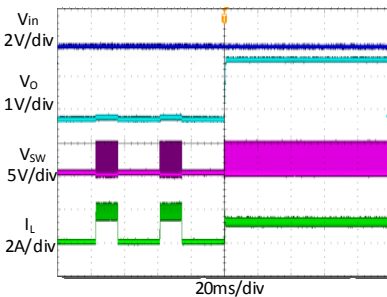

Load Transient

0.6A LOAD → 1.2A LOAD → 0.6A LOAD

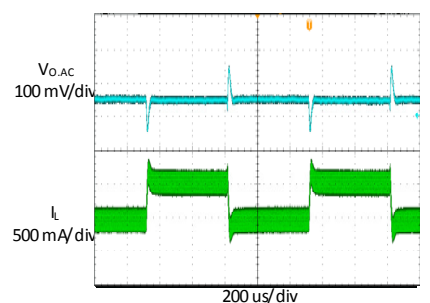

IMPORTANT NOTICE

- Joulwatt Technology Inc. reserves the right to make modifications, enhancements, improvements, corrections or other changes without further notice to this document and any product described herein.
- Any unauthorized redistribution or copy of this document for any purpose is strictly forbidden.
- Joulwatt Technology Inc. does not warrant or accept any liability whatsoever in respect of any products purchased through unauthorized sales channel.

JoulWatt Confidential

Copyright © 2017JW5223_S0_R0 _ Incorporated.

All rights are reserved by Joulwatt Technology Inc.