

RSEN SERIES

Multipurpose Single-Phase Filter with Various Variations and Functions

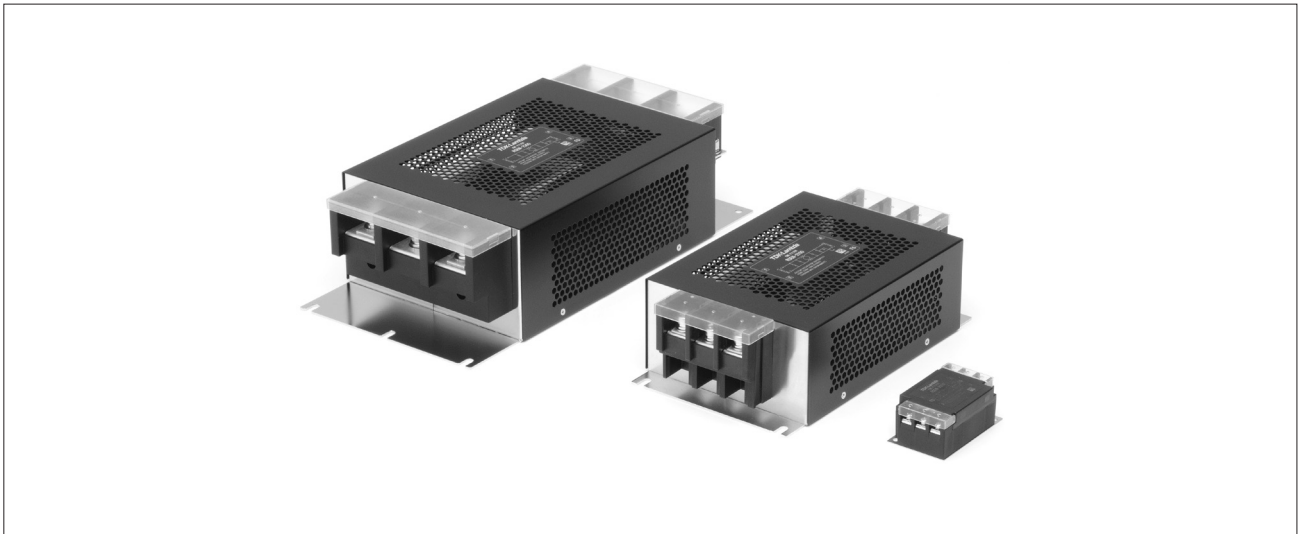

FEATURES

- Self-tightening screws and an open/close type cover make wiring work easier.
- 3 to 300A wide range lineup.
- Optional low-leakage current characteristic type and DIN rail installation compatible type are also available.

SAFETY STANDARDS

UL1283	UL File No. E62388 (Up to 60A)
CSA C22.2 No.8	CSA File No. LR76849 (Up to 60A)
EN60939-1/-2 (ENEC14)	Licence Ref. No. SE/07115-2 (Up to 60A)

PRODUCT IDENTIFICATION

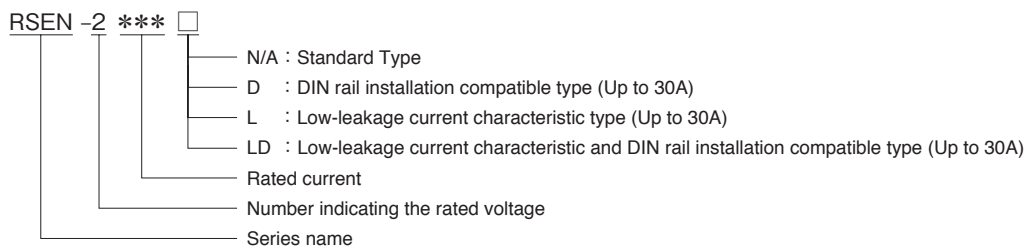

CONFORMITY TO RoHS Directive

CIRCUIT DIAGRAMS

RSEN-2 ***
RSEN-2 *** D

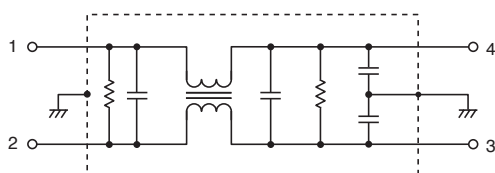

RSEN-2 *** L

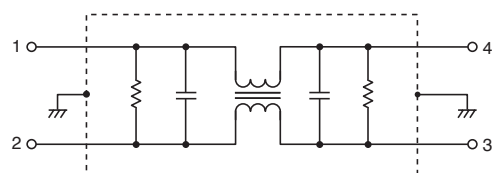

ELECTRICAL CHARACTERISTICS

Part No.	Rated voltage (AC/DC)	Rated current (AC/DC)	Withstand voltage	Insulation resistance	Leakage current	Operating temperature range	With derating over	DC resistance (mΩ)	Attenuation frequency range (MHz)			Weight (kg)
									Common mode		Differential mode	
									at 25dB	at 10dB	at 25dB	
RSEN-2003	250V	3A	AC.2500V 60s [Between line to ground]	100MΩ min. [DC.500V/ 1min]	1.0mA max. [250V/60Hz]	-25 to +85°C	55°C	250 max.	0.1 to 20	-	0.2 to 30	0.17
RSEN-2006		6A						110 max.	0.1 to 10	-	0.2 to 30	0.23
RSEN-2010		10A						40 max.	0.2 to 20	-	0.2 to 30	0.23
RSEN-2016		16A						20 max.	0.3 to 20	-	0.3 to 30	0.23
RSEN-2020		20A						10 max.	0.4 to 30	-	0.3 to 30	0.23
RSEN-2030		30A						6 max.	2 to 30	-	0.4 to 30	0.23
RSEN-2040		40A						6 max.	2 to 10	-	0.2 to 30	0.87
RSEN-2050		50A						4 max.	2 to 10	-	0.2 to 30	0.87
RSEN-2060		60A						3 max.	2 to 10	-	0.2 to 30	0.87
RSEN-2080		80A						3.4 max.	2 to 10	-	0.1 to 30	3.60
RSEN-2100		100A						2.7 max.	2 to 10	-	0.1 to 30	3.80
RSEN-2150		150A						2 max.	2 to 10	-	0.1 to 30	5.80
RSEN-2200		200A						1.4 max.	-	0.4 to 30	0.1 to 30	8.40
RSEN-2250		250A						1 max.	-	1 to 20	0.1 to 30	8.10
RSEN-2300	300A	0.7 max.	-	2 to 20	0.1 to 30	7.80						

Part No.	Rated voltage (AC/DC)	Rated current (AC/DC)	Withstand voltage	Insulation resistance	Leakage current	Operating temperature range	With derating over	DC resistance (mΩ)	Attenuation frequency range (MHz)			Weight (kg)
									Common mode		Differential mode	
									at 25dB	at 10dB	at 25dB	
RSEN-2003L	250V	3A	AC.2500V 60s [Between line to ground]	100MΩ min. [DC.500V/ 1min]	10 μA max. [250V/60Hz]	-25 to +85°C	55°C	250 max.	0.1 to 2	-	0.2 to 30	0.17
RSEN-2006L		6A						110 max.	0.1 to 2	-	0.2 to 30	0.22
RSEN-2010L		10A						40 max.	-	0.1 to 10	0.2 to 30	0.23
RSEN-2016L		16A						20 max.	-	0.1 to 10	0.2 to 30	0.23
RSEN-2020L		20A						10 max.	-	0.2 to 10	0.3 to 30	0.23
RSEN-2030L		30A						6 max.	-	0.3 to 5	0.3 to 30	0.23

DERATING GRAPHS

RSEN-2003/2006/2010/2016/2020/2030/
2040/2050/2060

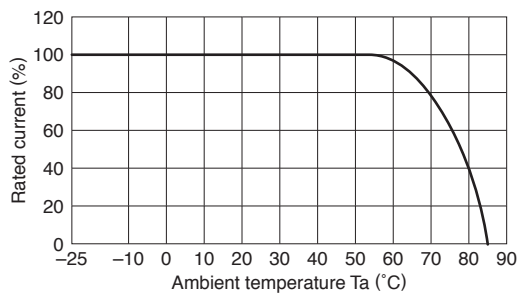

RSEN-2080/2100/2150/2200/2250/2300

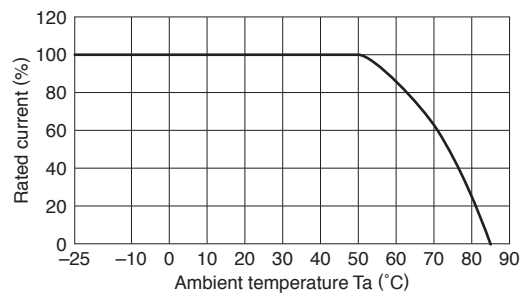

MECHANICAL

RSEN-2003/2006/2010/2016/2020/2030

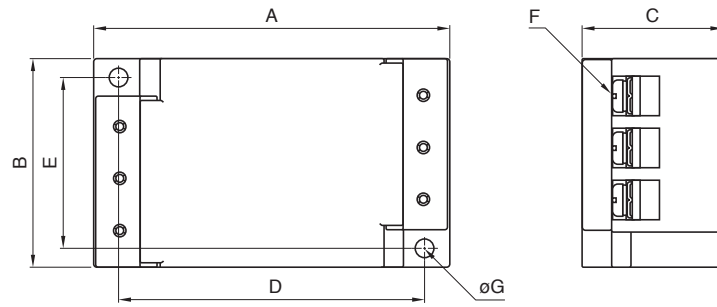

RSEN-2040/2050/2060

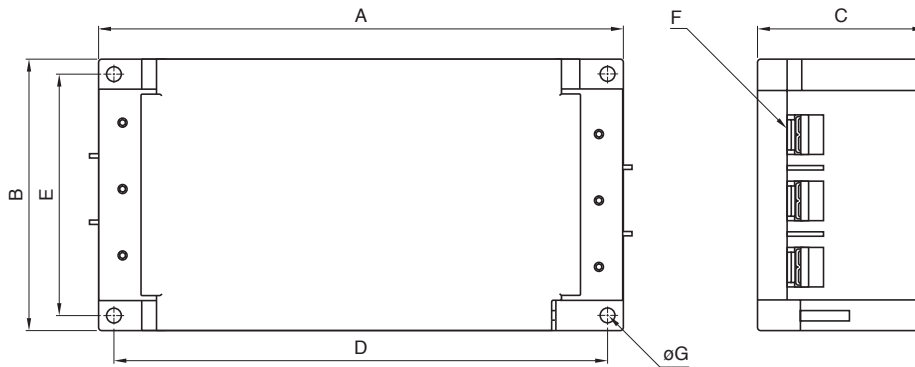

Dimensions in mm

Part No.	A	B	C	D	E	F	ϕG	Recommended clamping torque
RSEN-2003	87	52	35	75	43	M4	4.5	1.27N · m
RSEN-2006								
RSEN-2010								
RSEN-2016								
RSEN-2020								
RSEN-2030	170	90	54	160	80	M5	4.5	2.5N · m
RSEN-2040								
RSEN-2050								
RSEN-2060								

RSEN-2080/2100/2150

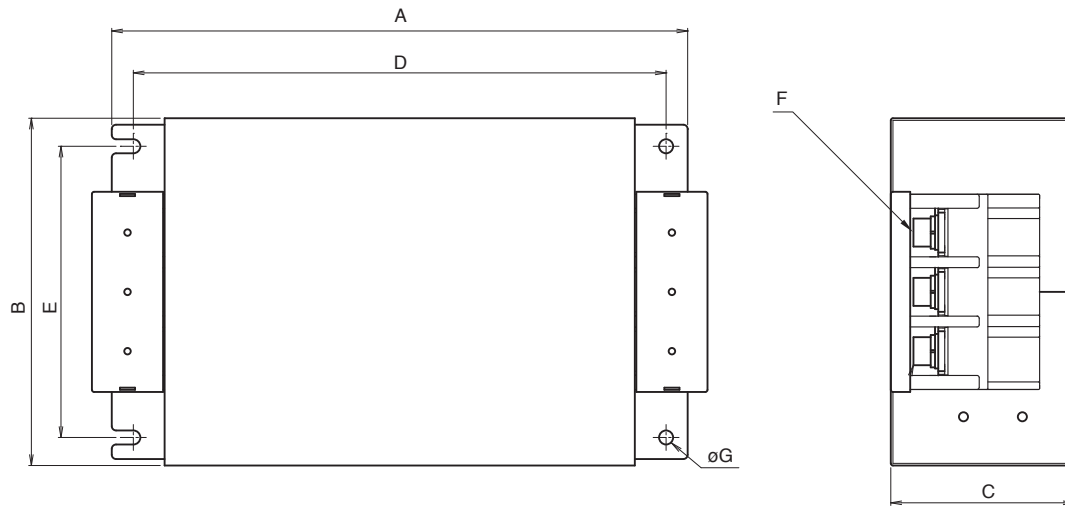

RSEN-2200/2250/2300

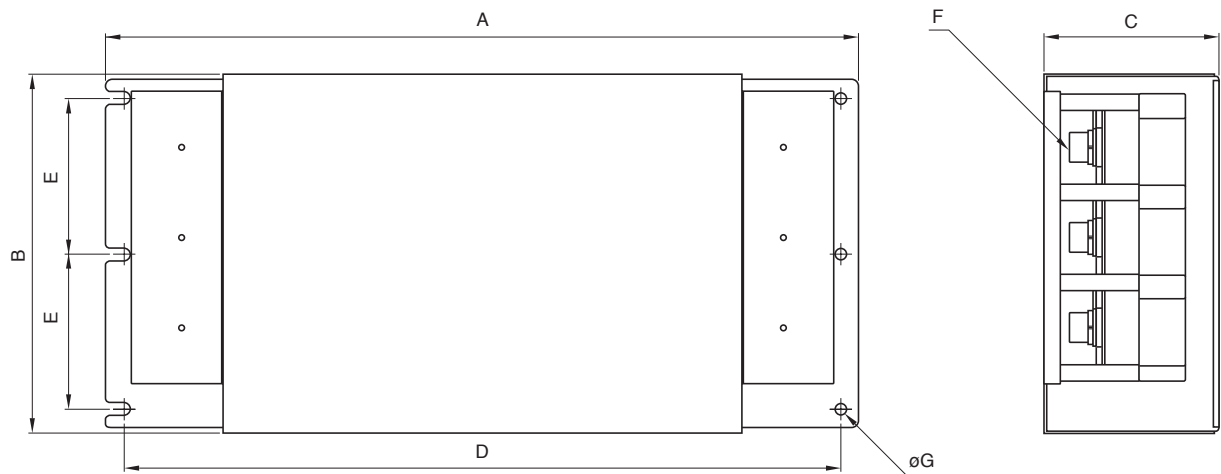

Dimensions in mm

Part No.	A	B	C	D	E	F	ϕG	Recommended clamping torque
RSEN-2080	267	161	85	247	135	M8	6.5	7.64N · m
RSEN-2100								
RSEN-2150								
RSEN-2200	390	195	103	370	84.5	M10	6.5	11.8N · m
RSEN-2250								
RSEN-2300								

RSEN-2003D/2006D/2010D/2016D/2020D/2030D

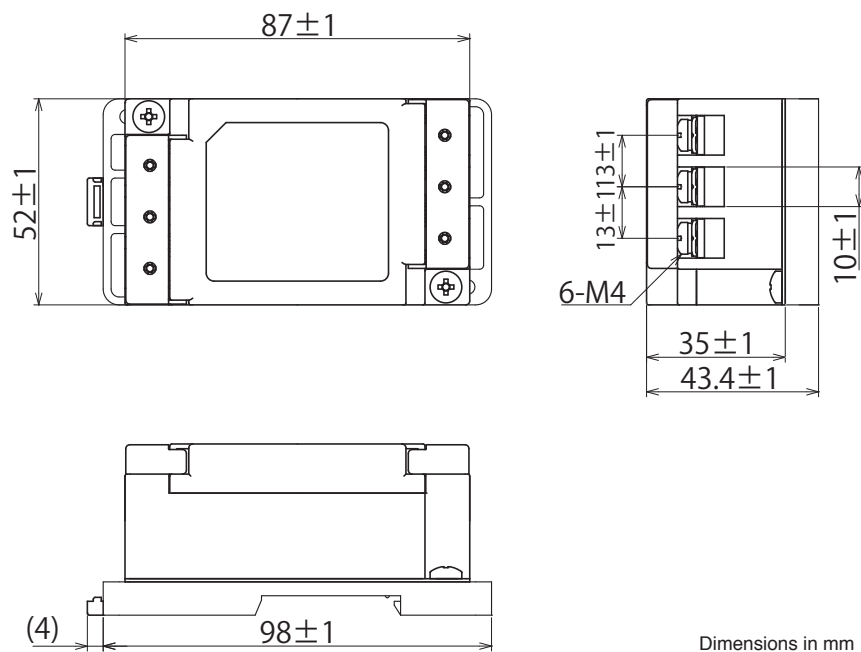

Dimensions in mm

■ ATTENUATION vs. FREQUENCY CHARACTERISTICS

RSEN-2003

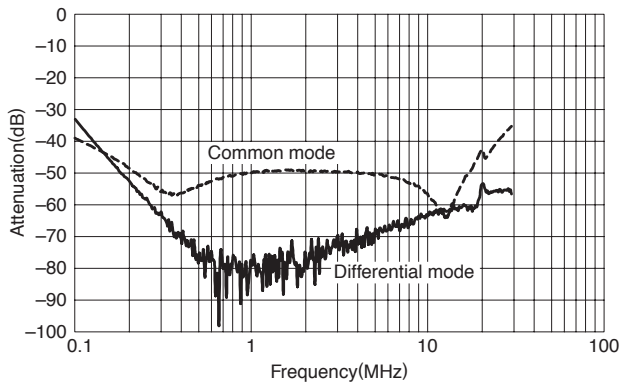

RSEN-2006

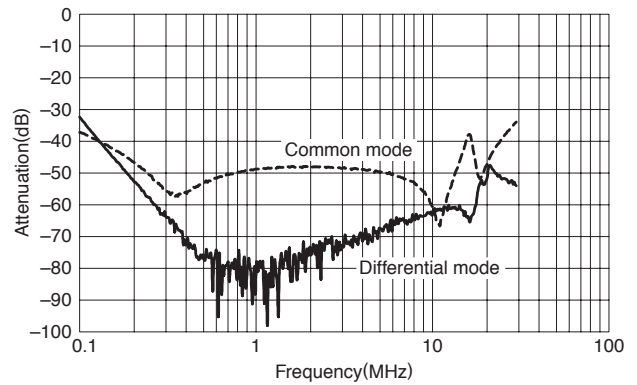

RSEN-2010

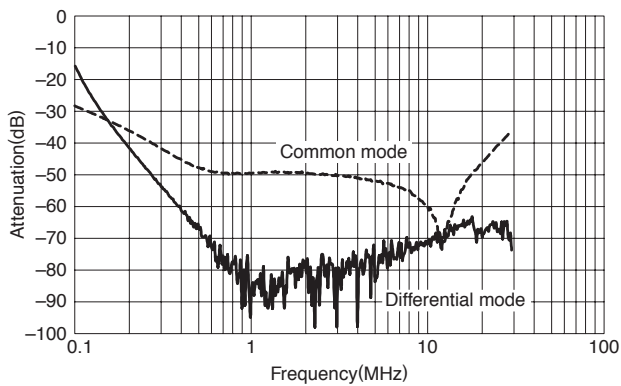

RSEN-2016

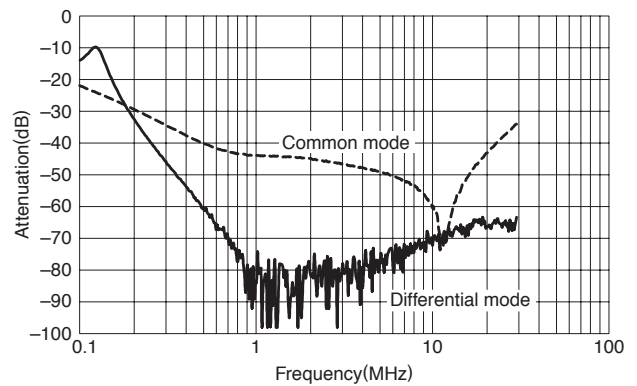

RSEN-2020

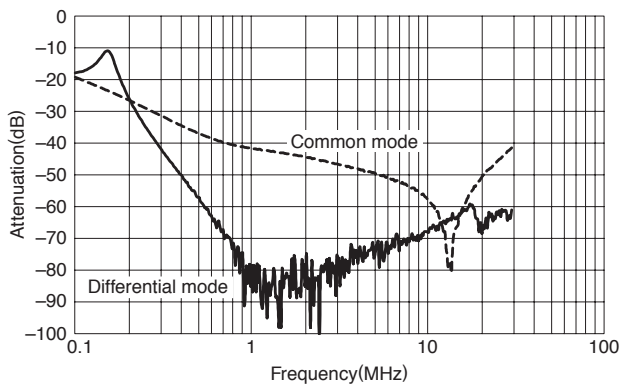

RSEN-2030

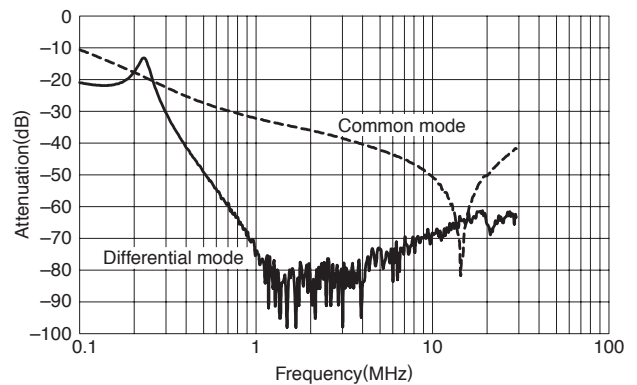

RSEN-2040

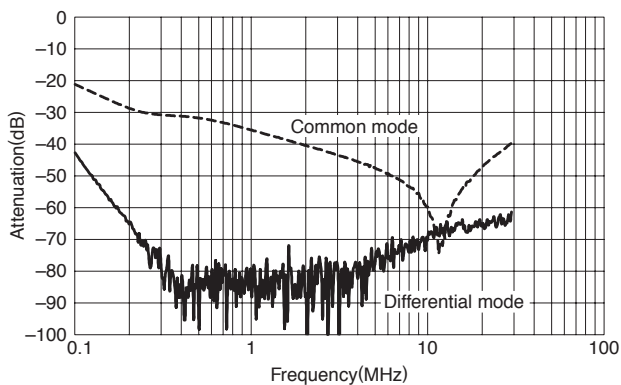

RSEN-2050

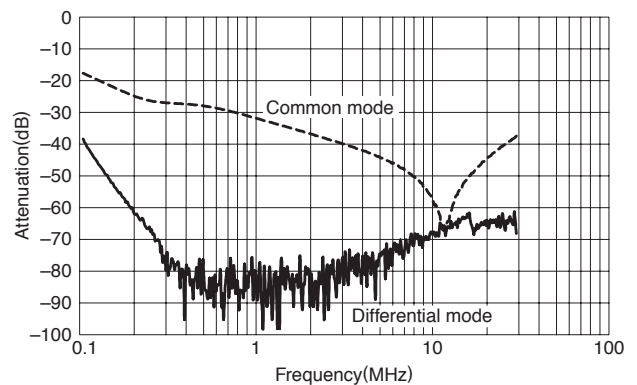

RSEN-2060

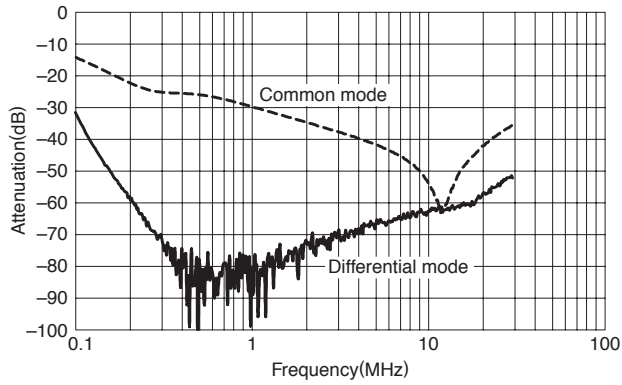

RSEN-2080

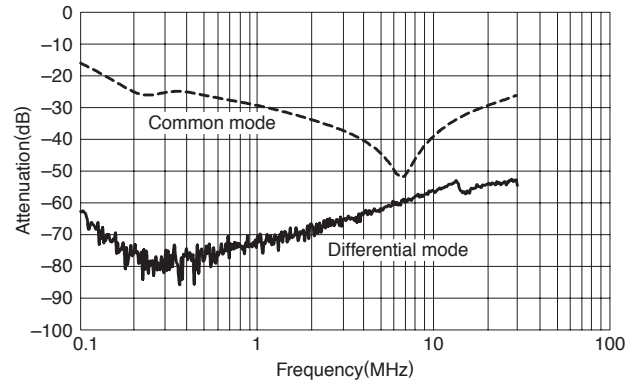

RSEN-2100

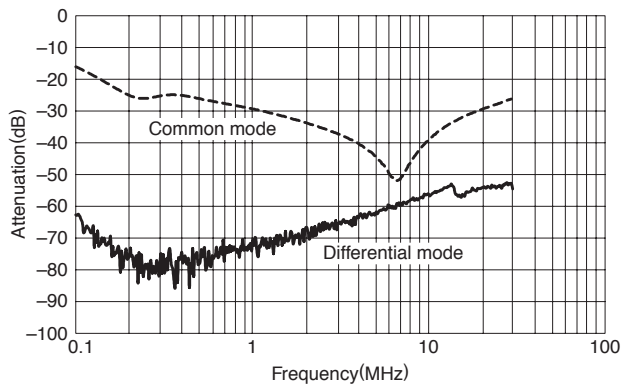

RSEN-2150

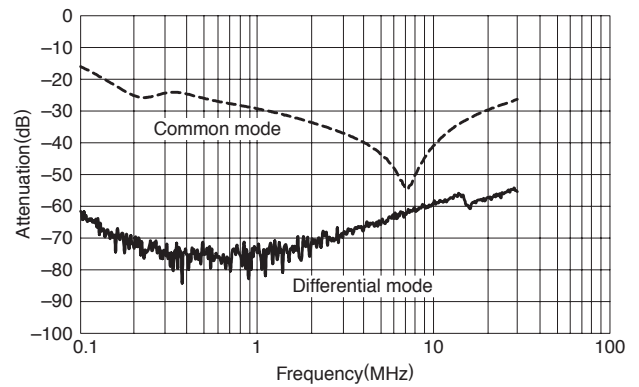

RSEN-2200

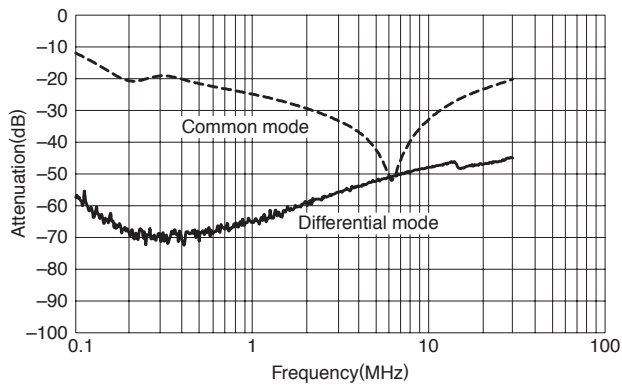

RSEN-2250

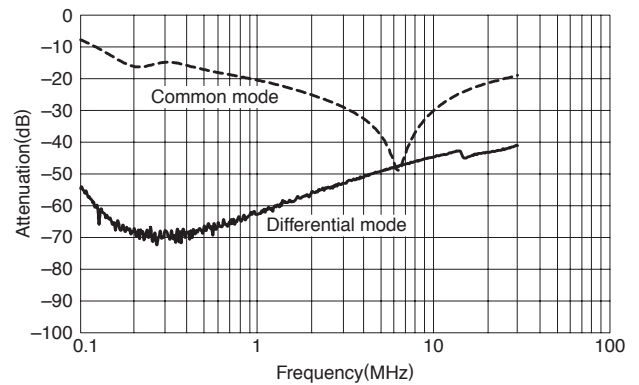

RSEN-2300

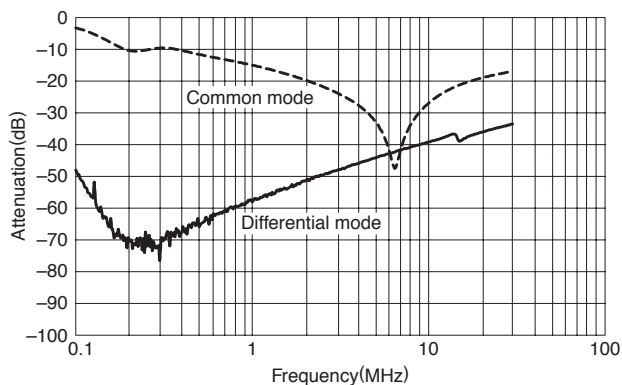

RSEN-2003L

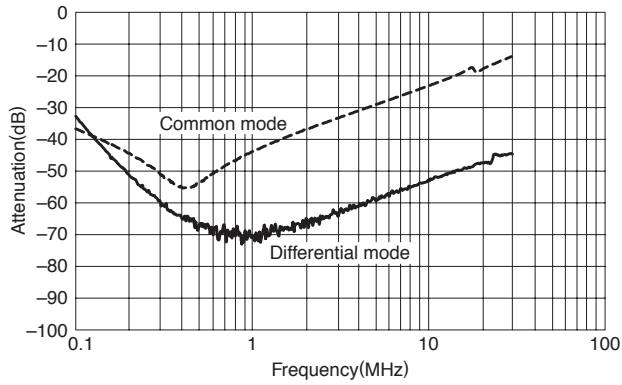

RSEN-2006L

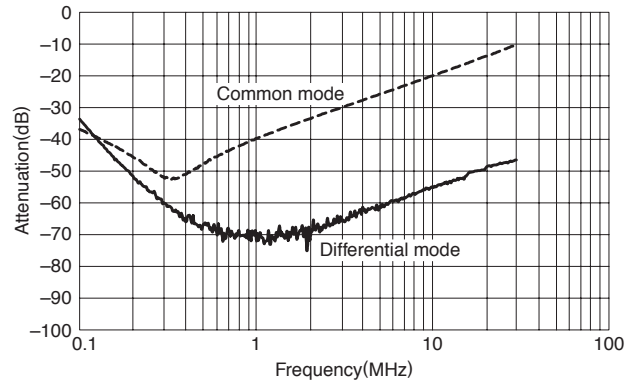

RSEN-2010L

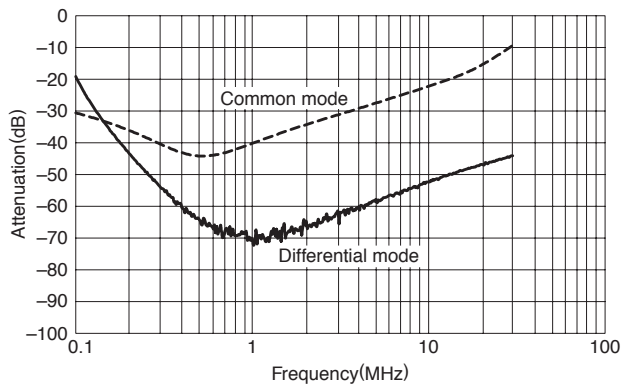

RSEN-2016L

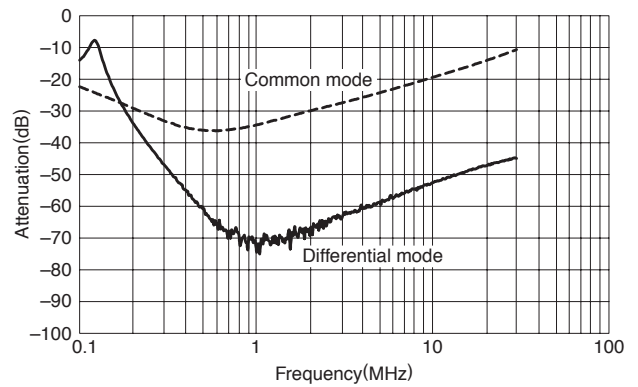

RSEN-2020L

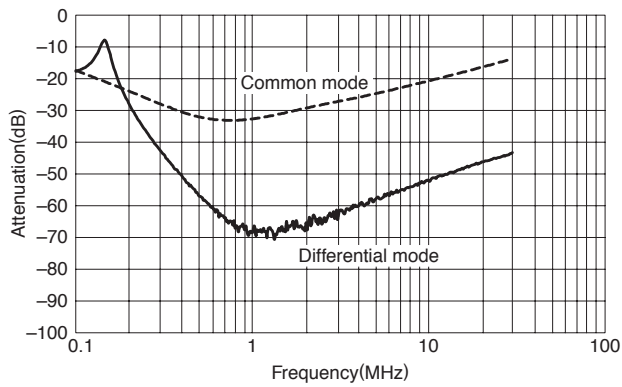

RSEN-2030L

