



COMPACT Splicing Connectors; 3-conductor connector; with operating levers; Max.ambient operating temp. 85 °C

Item No.: 221-413



COMPACT Splicing Connectors; 3-conductor connector; with operating levers; Max.ambient operating temp. 85 °C

Marking

RoHS ✓
Compliant

Business data

Supplier	WAGO
Item no.	221-413
GTIN / EAN	4050821808442
Content	1
Order amount	50
Customer item number	

Notes

Technical data

Miscellaneous

Total number of connection points	3
Total number of potentials	1
Color	transparent
Ratings per	EN 60664
Rated voltage (II / 2) [V]	450 [V]
Rated impulse voltage (II / 2) [kV]	4 [kV]

Technical data	
<i>Rated current [A]</i>	<i>32 [A]</i>
<i>Connection technology</i>	<i>CAGE CLAMP®</i>
<i>Number of connection points connector</i>	<i>3</i>
<i>Actuation type</i>	<i>Operating lever</i>
<i>Connectable conductor materials</i>	<i>Copper</i>
<i>Nominal cross section</i>	<i>4 mm²</i>
<i>Solid conductor</i>	<i>0.2 ... 4 mm² / 24 ... 12 AWG</i>
<i>Stranded conductor</i>	<i>0.2 ... 4 mm² / 24 ... 12 AWG</i>
<i>Fine-stranded conductor</i>	<i>0.14 ... 4 mm² / 24 ... 12 AWG</i>
<i>Strip length</i>	<i>11 mm / 0.43 Inch</i>
<i>Type of wiring</i>	<i>Side-entry wiring</i>
<i>Flammability class per UL94</i>	<i>V2</i>
<i>Weight [g]</i>	<i>2.527 [g]</i>
<i>Width</i>	<i>18.7 mm / 0.736 Inch</i>
<i>Height</i>	<i>8.3 mm / 0.327 Inch</i>
<i>Depth</i>	<i>18.6 mm / 0.732 Inch</i>
<i>Safety information 1</i>	<i>In grounded power lines</i>

Images & drawings





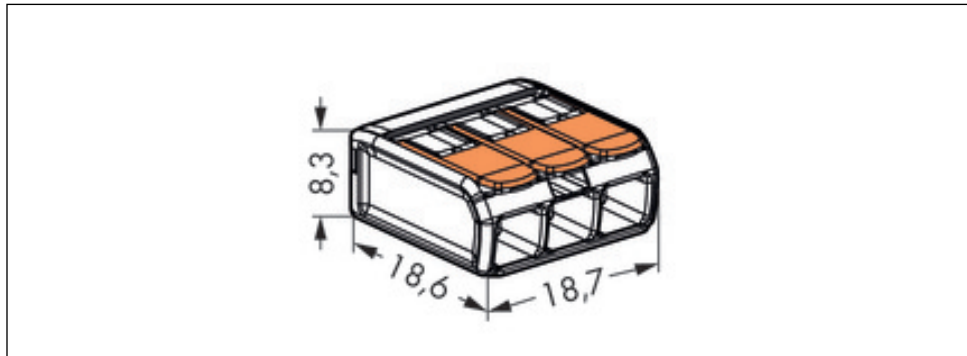

Address

WAGO Kontakttechnik GmbH & Co. KG

Hansastr. 27

32423 Minden

Telefon: 0571/887-0

Fax: 0571/887-169

<http://www.wago.com>

© WAGO Kontakttechnik GmbH & Co. KG

Technische Änderungen und Irrtümer vorbehalten.