

SERIES: VF-S320-XXA-CFS | **DESCRIPTION:** AC-DC POWER SUPPLY**FEATURES**

- up to 320 W continuous power
- 700 W peak power within 500 μ s duty duration
- metal top cover and side fan
- passive power factor correction
- power good signal
- 3,000 Vac isolation voltage
- over load, over voltage, over temperature, and short circuit protections
- UL/EN/IEC 62368 certified
- efficiency up to 83%



| MODEL | output voltage | output current | output ¹ power | ripple and noise ^{2,3} | efficiency |
|------------------|----------------|----------------|---------------------------|---------------------------------|------------|
| | (Vdc) | max (A) | max (W) | max (mVp-p) | typ (%) |
| VF-S320-05A-CFS* | 5 | 45 | 225 | 50 | 75% |
| VF-S320-09A-CFS* | 9 | 29.1 | 262 | 90 | 83% |
| VF-S320-12A-CFS | 12 | 26.67 | 320 | 120 | 80% |
| VF-S320-15A-CFS | 15 | 21.33 | 320 | 150 | 83% |
| VF-S320-18A-CFS | 18 | 17.78 | 320 | 180 | 83% |
| VF-S320-24A-CFS | 24 | 13.33 | 320 | 240 | 83% |
| VF-S320-28A-CFS | 28 | 11.43 | 320 | 280 | 83% |
| VF-S320-36A-CFS | 36 | 8.89 | 320 | 360 | 83% |
| VF-S320-48A-CFS | 48 | 6.67 | 320 | 480 | 83% |
| VF-S320-54A-CFS | 54 | 5.93 | 320 | 540 | 83% |

Notes: 1. 1% minimum load is required to maintain the ripple and regulation.
 2. Ripple and noise is measured from 10 KHz to 20 MHz at output terminals with a 0.1 μ F ceramic capacitor and a 22 μ F electrolytic capacitor in parallel.
 3. * Discontinued model.

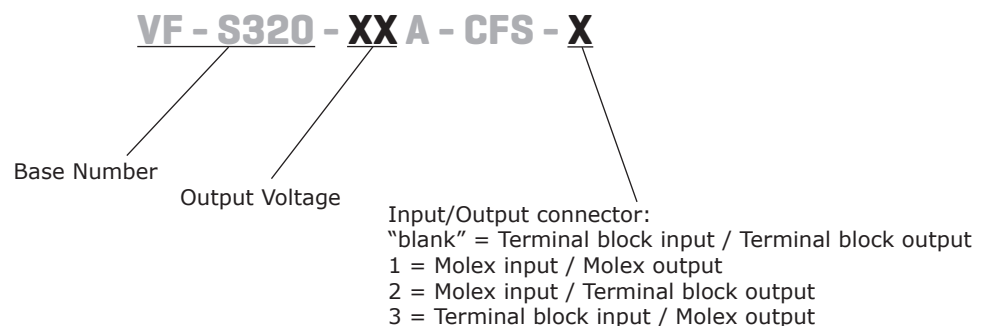
PART NUMBER KEY

INPUT

| parameter | conditions/description | min | typ | max | units |
|----------------|--|--------|-----|----------|--------|
| voltage | 90-132/180-264 auto selectable | 90/180 | | 132/264 | Vac |
| frequency | | 47 | | 63 | Hz |
| current | at 100~120 Vac, cold start at 200~240 Vac, cold start | | | 8 4 | A A |
| inrush current | at 115 Vac, full load, cold start at 230 Vac, full load, cold start | | | 35 70 | A A |
| power factor | compliant to EN 61000-3-2 class A | | | | |

OUTPUT

| parameter | conditions/description | min | typ | max | units |
|-------------------------|---|-----|------|-----|-------|
| line regulation | low line to high line | | ±1 | | % |
| load regulation | all other outputs | | ±1 | | % |
| temperature coefficient | | | 0.25 | | mV/°C |
| transient response | Output voltage returns to within 1% in less than 2.5 ms for a 50% load change. Peak transient does not exceed 5%. | | | | |
| start-up time | at 120 Vac | | | 1 | s |
| rise time | | 0.2 | | 20 | ms |
| hold-up time | at 120 Vac and 80% of rated maximum load | 20 | | | ms |
| adjustability | | | ±5 | | % |
| power good | Designated as PG on the CN1. This signal goes high 100-500 mS after the output reaches regulation. It goes low at least 1 mS before loss of regulation. | | | | |
| fan drive | 12 Vdc / 300 mA for external fan | | | | |

PROTECTIONS

| parameter | conditions/description | min | typ | max | units |
|-----------------------------|---|-----|-----|-----|-------|
| over voltage protection | AC input needs to be reset to restart the power supply. | | | 130 | % |
| over current protection | automatically recovers | | 110 | 140 | % |
| short circuit protection | short circuit can be continuous, recovers automatically upon removal of short | | | | |
| over temperature protection | auto recovery | | | 85 | °C |

SAFETY & COMPLIANCE

| parameter | conditions/description | min | typ | max | units |
|-------------------|--|-------------------------|-----|------------|-------------------|
| isolation voltage | applied for 3 seconds at 10 mA max. primary to secondary primary to transformer core primary to earth chassis | 3,000 1,500 1,500 | | | Vac Vac Vac |
| safety approvals | certified to 62368: IEC, EN, UL | | | | |
| EMI/EMC | pass FCC Part 15, CISPR 22 class B, conducted | | | | |
| leakage current | at 240 Vac at 120 Vac | | | 500 300 | µA µA |
| RoHS compliant | yes | | | | |
| MTBF | according to MIL-HDBK-217 at 30 °C | 100,000 | | | hrs |

ENVIRONMENTAL

| parameter | conditions/description | min | typ | max | units |
|-----------------------|---|-----|-----|-----|-------|
| operating temperature | see derating curve | 0 | | 70 | °C |
| storage temperature | | -20 | | 85 | °C |
| operating humidity | non-condensing | 5% | | 90% | % |
| storage humidity | non-condensing | 5% | | 95% | % |
| vibration | acceleration ± 7.35 M/(SxS), on X, Y and Z Axis | 5 | | 50 | Hz |

DERATING CURVES

TEMPERATURE DERATING CURVE

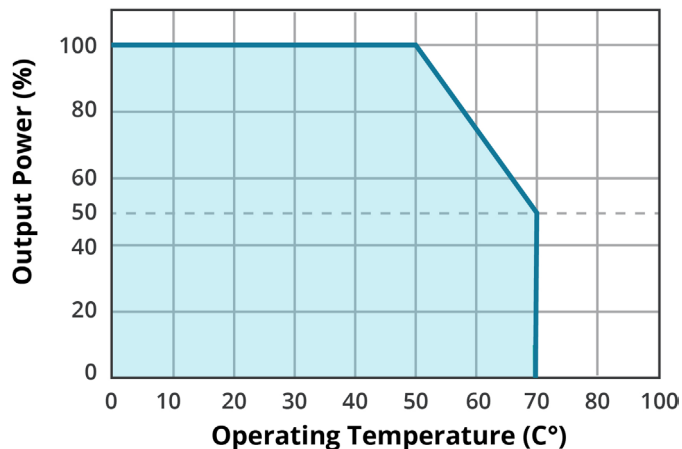

MECHANICAL

| parameter | conditions/description | min | typ | max | units |
|------------|--|-----|-----|-----|-------|
| dimensions | 177.80 x 101.60 x 39.30 [7 x 4 x 1.6 inch] | | | | mm |
| weight | | | | 750 | g |

MECHANICAL DRAWING

units: mm[inches]
 tolerance: ±0.3 mm
 unless otherwise specified

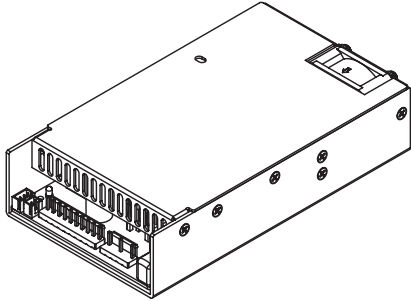

SCALE: 1:3

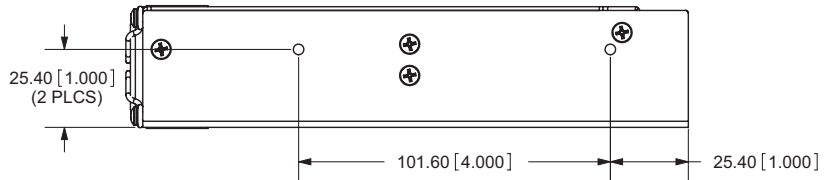

| CN1 | |
|-----|------------|
| 1 | ground |
| 2 | ac neutral |
| 3 | ac line |

| CN2 | |
|-----|-----|
| 1 | Vo+ |
| 2 | Vo+ |
| 3 | Vo+ |
| 4 | Vo+ |
| 5 | Vo+ |
| 6 | Vo- |
| 7 | Vo- |
| 8 | Vo- |
| 9 | Vo- |
| 10 | Vo- |

| CN3 | |
|-----|------------|
| 1 | power good |
| 2 | RTN |
| 3 | fan fail |

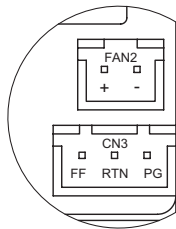

DETAIL A
 SCALE 2:1

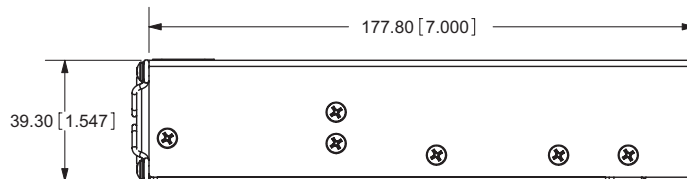
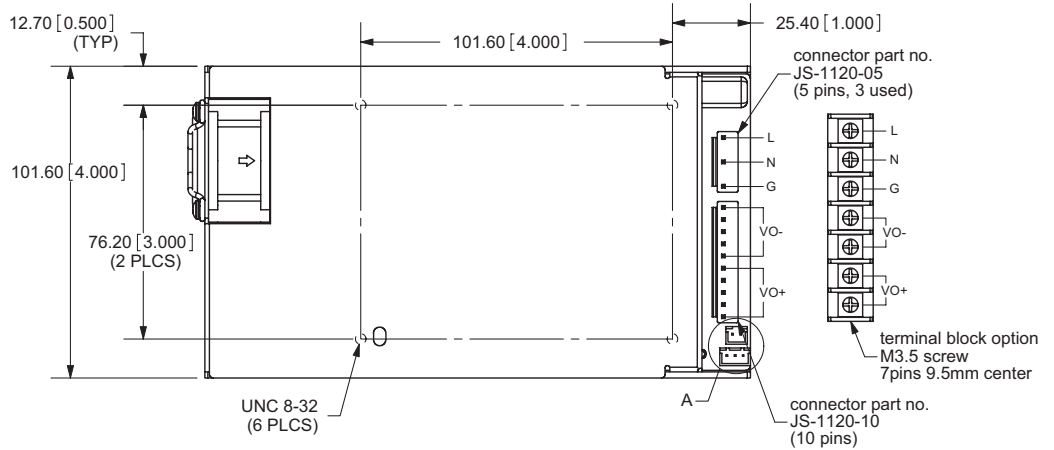

- Notes:
1. CN1 mates with JST VH series 5-pin connector.
 2. CN2 mates with VH series 10-pin connector.
 3. CN3 mates with JST XHP-3 or equivalent (CHYAO SHIUNN JS-2001-03) and JST SXH-002T-P0.6 mating pins
 4. Fan drive connector mates with JST part no. XHP-2 or equivalent
 5. Mounting hole max depth 4.00mm

REVISION HISTORY

| rev. | description | date |
|------|--|------------|
| 1.0 | initial release | 05/5/2009 |
| 1.01 | new template applied | 12/17/2011 |
| 1.02 | V-Infinity branding removed | 08/28/2012 |
| 1.03 | removed on/off information, removed low leakage option, updated spec | 04/23/2013 |
| 1.04 | company logo updated | 12/22/2020 |
| 1.05 | safeties updated | 02/10/2021 |
| 1.06 | derating curve updated | 04/21/2021 |
| 1.07 | discontinued models VF-S320-05A-CFS & VF-S320-09A-CFS | 06/02/2022 |

The revision history provided is for informational purposes only and is believed to be accurate.



CUI INC

a bel group

Headquarters
20050 SW 112th Ave.
Tualatin, OR 97062
800.275.4899

Fax 503.612.2383
cui.com
techsupport@cui.com

CUI offers a two (2) year limited warranty. Complete warranty information is listed on our website.

CUI reserves the right to make changes to the product at any time without notice. Information provided by CUI is believed to be accurate and reliable. However, no responsibility is assumed by CUI for its use, nor for any infringements of patents or other rights of third parties which may result from its use.

CUI products are not authorized or warranted for use as critical components in equipment that requires an extremely high level of reliability. A critical component is any component of a life support device or system whose failure to perform can be reasonably expected to cause the failure of the life support device or system, or to affect its safety or effectiveness.