

**SERIES:** SWI5-N | **DESCRIPTION:** AC-DC POWER SUPPLY

**FEATURES**

- up to 6 W continuous power
- DoE Level VI efficiency
- universal input voltage range
- ultra-compact case
- no load power consumption < 0.075 W
- over voltage, over current, and short circuit protections
- UL/cUL, PSE, FCC safety approvals
- Class II construction
- IEC 62368-1
- black and white case options



MODEL	output voltage typ (Vdc)	output current max (A)	output power max (W)	ripple and noise <sup>1</sup> max (mVp-p)	efficiency level
SWI5-5-N	5	1	5	300	VI
SWI5-5B-N	5	1.2	6	300	VI
SWI5-9-N	9	0.6	5.4	300	VI
SWI5-12-N	12	0.5	6	300	VI

Notes: 1. At full load, 25°C, at 115/230 Vac input, 20 MHz bandwidth oscilloscope, output terminated with 0.1 µF and 10 µF capacitors.

**PART NUMBER KEY**

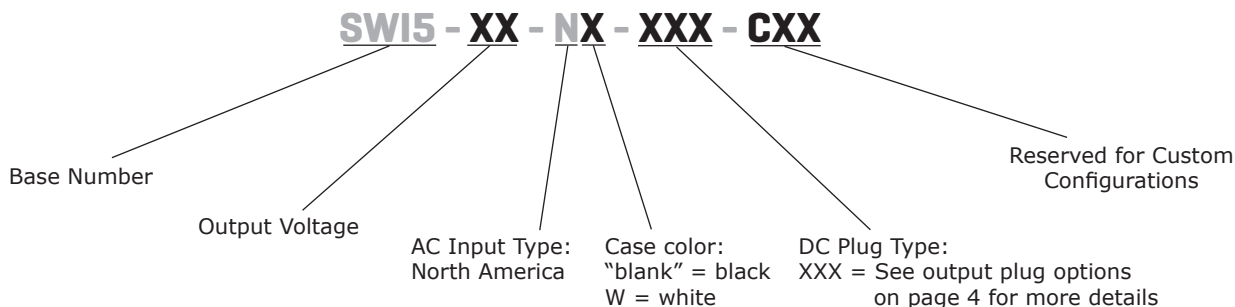

## INPUT

parameter	conditions/description	min	typ	max	units
voltage		90		264	Vac
frequency		47		63	Hz
current	at nominal input voltage			0.2	A
leakage current	at nominal input voltage & frequency			0.25	mA
no load power consumption	at 115/230 Vac, 60/50 Hz			0.075	W

## OUTPUT

parameter	conditions/description	min	typ	max	units
line regulation			±5		%
load regulation			±5		%
start-up time				3	s
hold-up time	at nominal input voltage & full load	5			ms

## PROTECTIONS

parameter	conditions/description	min	typ	max	units
over voltage protection	5 Vdc output model			6.5	Vdc
	5 Vdc output B model			8.0	Vdc
	9 Vdc output model			18.0	Vdc
	12 Vdc output model			15.6	Vdc
over current protection	output shut down, auto recovery				
	5 Vdc output model			1.8	A
	5 Vdc output B model			2.4	A
	9 Vdc output model			1.2	A
short circuit protection	12 Vdc output model			0.9	A

## SAFETY & COMPLIANCE

parameter	conditions/description	min	typ	max	units
isolation voltage	input to output at 10 mA for 1 minute		3,000 4,242		Vac Vdc
safety approvals	62368: UL 60950: PSE				
EMI/EMC	FCC Part 15B Class B				
MTBF	as per Telcordia SR-332 (Issue 2), at 115/230 Vac, full load, 0°C~40°C	50,000			hours
RoHS	2011/65/EU				

## ENVIRONMENTAL

parameter	conditions/description	min	typ	max	units
operating temperature		0		40	°C
storage temperature		-20		60	°C
operating humidity	non-condensing	20		85	%
storage humidity	non-condensing	5		95	%

## MECHANICAL

parameter	conditions/description	min	typ	max	units
dimensions	66.5 x 25.4 x 51.3				mm
inlet plug	North America, 2-pin				
weight			58		g

## MECHANICAL DRAWING

units: mm

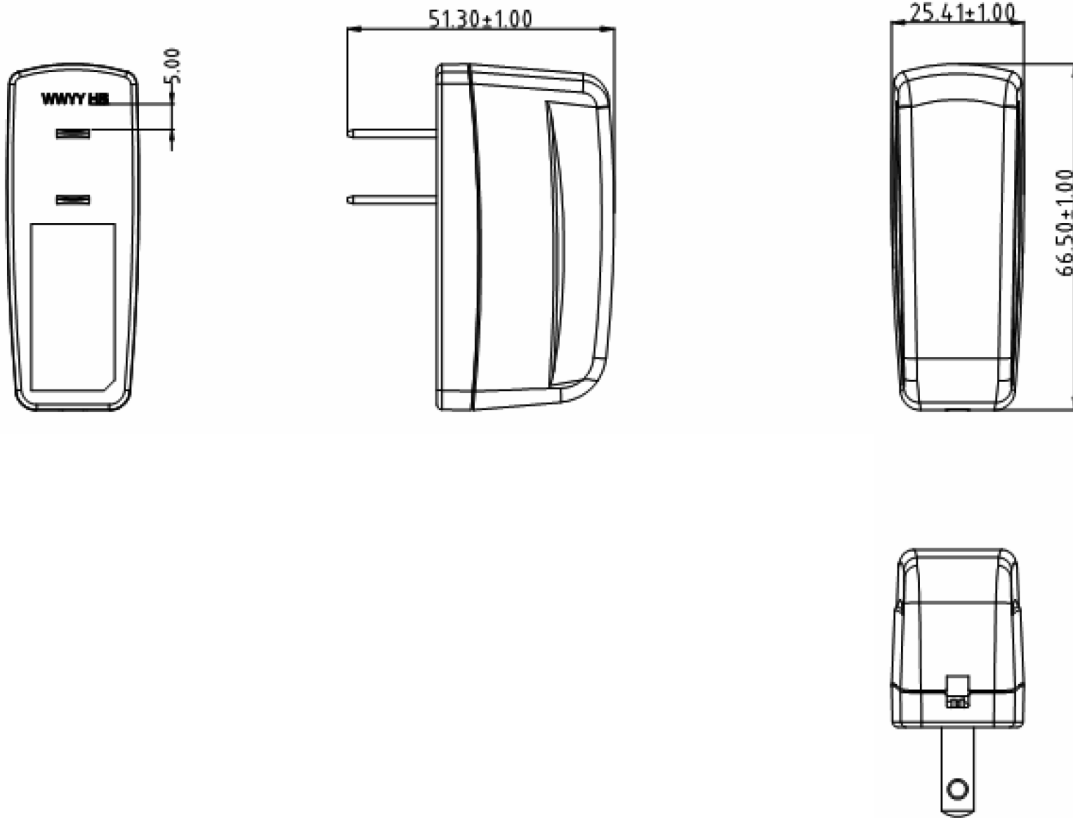

## DC CORD

units: mm

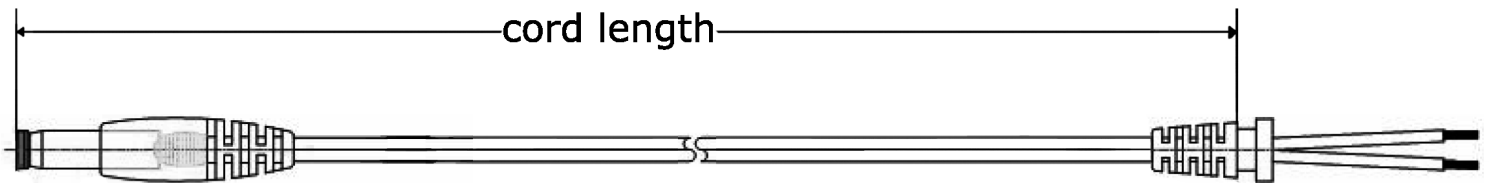

**Table 1**

MODEL NO.	CABLE	CORD LENGTH
SWI5-5-N	UL2468, 24 AWG	1,500 mm ±50
SWI5-5B-N	UL2468, 24 AWG	1,500 mm ±50
SWI5-9-N	UL2468, 24 AWG	1,500 mm ±50
SWI5-12-N	UL2468, 24 AWG	1,500 mm ±50

## DC PLUG TYPE PART NUMBER KEY

**XXX**

**Plug Polarity:**  
P = Center Positive  
N = Center Negative

**Plug Code:**  
X = Choose a code from the options below

**Plug Angle:**  
"blank" = Straight  
R = Right Angle

Plug Polarity		Code		Dimensions (mm)			Plug Angle	
Center Pos.	Center Neg.	Option	Type	A	B	C	Straight	Right
•	•	5	Standard	5.5	2.1	9.5	•	•
•	•	6	Standard	5.5	2.5	9.5	•	•
•	•	7	Standard	3.5	1.35	9.5	•	•
•	•	8	Standard	3.8	1.35	9.5	•	•
•	•	9	Standard	3.8	1.05	9.5	•	•
•	•	10	Locking <sup>2</sup>	5.5	2.1	9.5	•	N/A
•	•	11	Locking <sup>2</sup>	5.5	2.5	9.5	•	N/A
•	•	12	EIAJ-1	2.35	0.7	9.5	•	•
•	•	13	EIAJ-2	4.0	1.7	9.5	•	•
•	•	14	EIAJ-3	4.75	1.7	9.5	•	•
N/A	N/A	ST	Stripped & Tinned				N/A	N/A
N/A	N/A	MUB	USB	Micro USB Type B			•	N/A

Note: 1. Contact CUI for additional plug options  
2. Maximum insertion depth is 10mm

### Standard

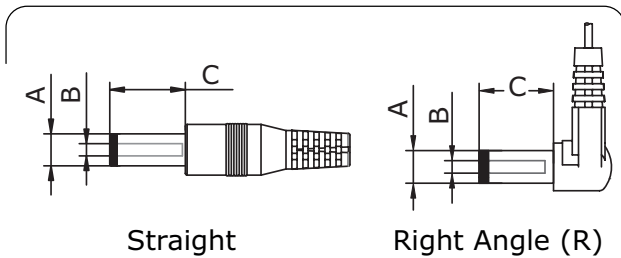

### EIAJ

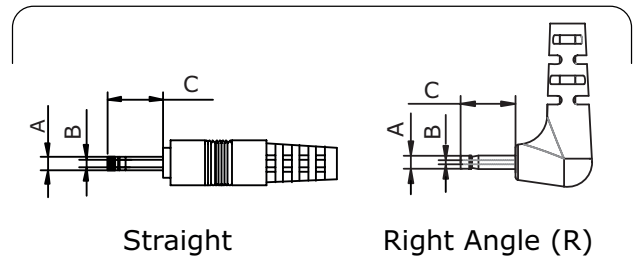

### Locking

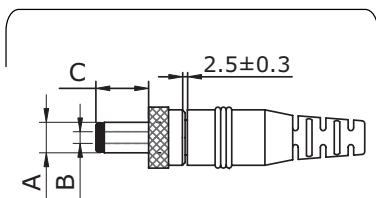

### Stripped & Tinned

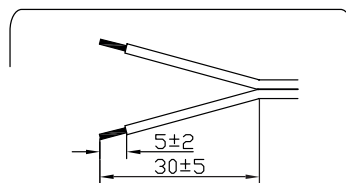

### USB

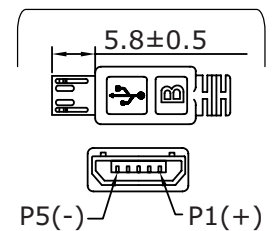

## REVISION HISTORY

rev.	description	date
1.0	initial release	11/23/2016
1.01	company logo updated	09/21/2020
1.02	safety marks updated	04/22/2021
1.03	specification updated to show 62368 on safety line	05/12/2021
1.04	updated datasheet	08/09/2021
1.05	product image updated	08/20/2021
1.06	minimum current ratings updated	11/04/2021
1.07	dc plugs updated	04/24/2022

The revision history provided is for informational purposes only and is believed to be accurate.



# CUI INC

a bel group

**Headquarters**  
20050 SW 112th Ave.  
Tualatin, OR 97062  
**800.275.4899**

Fax 503.612.2383  
**cui.com**  
techsupport@cui.com

This device complies with part 15 of the FCC Rules. Operation is subject to the following two conditions:

- (1) This device may not cause harmful interference, and
- (2) this device must accept any interference received, including interference that may cause undesired operation.

CUI offers a one (1) year limited warranty. Complete warranty information is listed on our website.

CUI reserves the right to make changes to the product at any time without notice. Information provided by CUI is believed to be accurate and reliable. However, no responsibility is assumed by CUI for its use, nor for any infringements of patents or other rights of third parties which may result from its use.

CUI products are not authorized or warranted for use as critical components in equipment that requires an extremely high level of reliability. A critical component is any component of a life support device or system whose failure to perform can be reasonably expected to cause the failure of the life support device or system, or to affect its safety or effectiveness.