

**FEATURES**

- Non-isolated SIP PoL DC/DC power module
- 2.4-5.5Vdc input voltage range
- Programmable output voltage from 0.7525-3.366Vdc
- Under Voltage shutdown (Vin)
- Drives 1000 µF ceramic capacitive loads
- High power conversion efficiency 95% at 3.3 Vout (typical)
- Outstanding thermal derating performance
- Over temperature and over current protection
- On/Off control
- UL60950, CSA-C22.2 No.60950 IEC/EN60950 (pending)
- Industry-standard (DOSA) SIP format
- RoHS-6 hazardous substance compliance

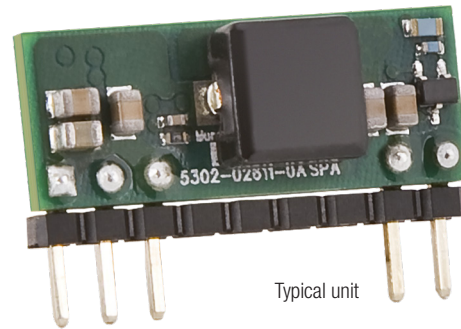

Typical unit

**PRODUCT OVERVIEW**

The OKX-T/5-W5 series are miniature SIP non-isolated Point-of-Load (PoL) DC/DC power converters for embedded applications. The module is fully compatible with Distributed-power Open Standards Alliance industry-standard specifications.

Applications include powering CPU's, datacom/telecom systems, programmable logic and mixed voltage systems. The wide input range is 2.4 to 5.5 Volts DC at 5 amps. Based on fixed-frequency syn-

chronous buck converter switching topology, the high power conversion efficient Point of Load (PoL) module features programmable output voltage and On/Off control. These converters also include under voltage lock out (UVLO), output short circuit protection, over-current and over temperature protections. These units are designed to meet all standard UL/EN/IEC 60950-1 safety certifications and RoHS-6 hazardous substance compliance.

**Connection Diagram**

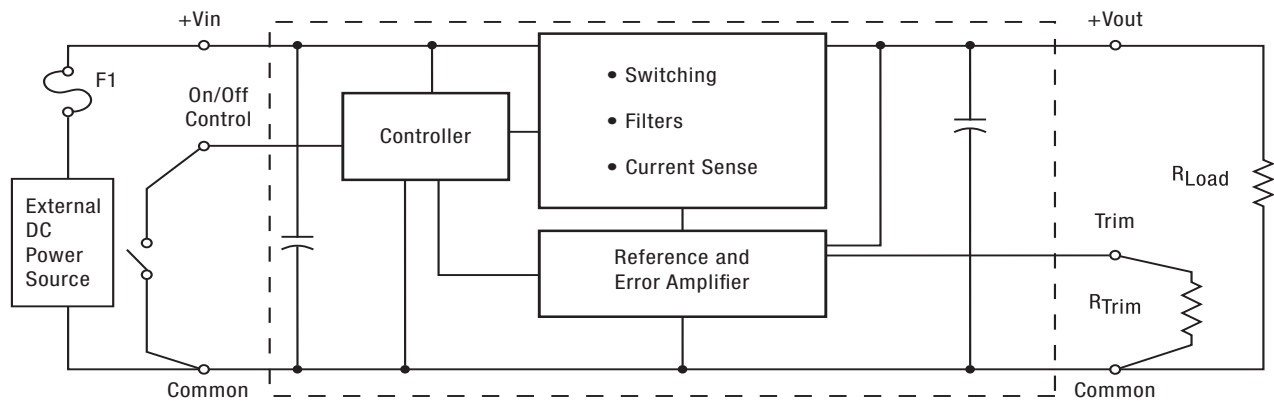

**Figure 1. OKX-T/5-W5**

Note: Murata Power Solutions strongly recommends an external input fuse, F1. See specifications.



PERFORMANCE SPECIFICATIONS SUMMARY AND ORDERING GUIDE													
Model Number ①	Output						Input				Efficiency		Dimensions in inches (mm)
	V <sub>OUT</sub> (Volts) ①	I <sub>OUT</sub> (Amps, max) ①	Power (Watts)	R/N (mVp-p) Max. ②	Regulation (Max.)		Vin Nom. (Volts)	Range (Volts) ③	I <sub>in</sub> , no load (mA)	I <sub>in</sub> , full load (Amps)	Min.	Typ.	
					Line	Load							
OKX-T/5-W5-C	.7525-3.6	5	16.5	40	±0.25%	±0.5%	5	2.4-5.5	20	3.474	92%	95.0%	0.40x0.90x0.282 (10.16x 22.86x 7.163)

① All specifications are typical at nominal line voltage, V<sub>OUT</sub>=nominal (3.3V for W5 models) and full load, +25°C.

③ The input voltage range must be 0.5V greater than the output voltage.

② Ripple and Noise (R/N) is shown at V<sub>OUT</sub>=1V. See specs for details.

**\* To Be Discontinued**

\* NOTE: the following models are TO BE DISCONTINUED:

OKX-T/5-W5N-C-FH

OKX-T/5-W5NL6-C

**\* Last time buy date is 3/31/2022.**

**PART NUMBER STRUCTURE**

**OK X - T / 5 - W5 N Lx - C**

- Okami Non-isolated PoL** (OK)
- SIP Mount** (X)
- Trimable Output Voltage Range** (T)  
W5 Models = 0.7525-3.63V
- Maximum Rated Output Current in Amps** (5)
- Input Voltage Range** (W5)  
W5 = 2.4-5.5V
- On/Off Polarity** (N)  
P = Positive Polarity  
N = Negative Polarity
- Pin Length Option** (Lx)  
Blank = Standard pin length  
L6 = Pin length 0.138 inches (3.5mm)\*
- RoHS Hazardous Substance Compliance** (C)  
C = RoHS-6 (does not claim EU RoHS exemption 7b-lead in solder)

**\*Special quantity order is required; samples available with standard pin length only.**

**Note:**  
Some model number combinations may not be available. See website or contact your local Murata sales representative.

**FUNCTIONAL SPECIFICATIONS, OKX-T/5-W5-C**

ABSOLUTE MAXIMUM RATINGS		Conditions ①	Minimum	Typical/Nominal	Maximum	Units
Input Voltage, Continuous		Full power operation	0		5.8	Vdc
Input Reverse Polarity		None, install external fuse		None		Vdc
On/Off Remote Control		Power on or off, referred to -Vin	0		5.5	Vdc
Output Power			0	16.5	16.83	W
Output Current		Current-limited, no damage, short-circuit protected	0		5	A
Storage Temperature Range		Vin = Zero (no power)	-55		125	°C
Absolute maximums are stress ratings. Exposure of devices to greater than any of these conditions may adversely affect long-term reliability. Proper operation under conditions other than those listed in the Performance/Functional Specifications Table is not implied or recommended.						
INPUT		Conditions ① ③				
Operating voltage range		$V_o < V_{in} - 0.5$	2.4	5	5.5	Vdc
Recommended External Fuse		Fast blow			6	A
Turn On/Start-up threshold		Rising input voltage	1.95	2.05	2.15	Vdc
Turn Off/Undervoltage lockout ⑤		Falling input voltage	1.73	1.9	2.07	Vdc
Reverse Polarity Protection		None, install external fuse		None		Vdc
Internal Filter Type				C-TYPE		
Input current						
Full Load Conditions		Vin = nominal (3.3Vo set)		3.474	3.659	A
Low Line		Vin @ min, 3.3 Vout		4.407	4.691	A
Inrush Transient				0.04		A <sup>2</sup> -Sec.
Short Circuit Input Current				150		mA
No Load Input Current		3.3Vout, Iout @ 0		20	50	mA
No Load Input Current		0.75V, Iout @ 0		15	40	mA
Shut-Down Mode Input Current				50		mA
Reflected (back) ripple current ②		Measured at input with specified filter		80		mA, pk-pk
GENERAL and SAFETY						
Efficiency		@ Vin nom, 3.3Vout	92	95		%
		@ Vin min >3.3Vdc	93	94.5		%
		@ Vin nom, 2.5Vout	90	92.5		%
		@ Vin nom, 1.8Vout	87	90		%
		@ Vin nom, 1.5Vout	86.5	88.5		%
		@ Vin nom, 1.2Vout	84	86		%
		@ Vin nom, 1Vout	81	84		%
	@ Vin nom, 0.7525Vout	78	81		%	
Safety (certified to the following requirements)		UL-60950-1, CSA-C22.2 No.60950-1, IEC/EN60950-1, 2nd edition (pending)		Yes		
Calculated MTBF ④		Class 3, ground fixed, Tambient=+25°C		TBD		Hours x 10 <sup>6</sup>
DYNAMIC CHARACTERISTICS						
Fixed Switching Frequency			250	300	350	KHz
Startup Time		Power On to Vout regulated 100% resistive load		8	10	mS
Startup Time		Remote ON to 10% Vout (50% resistive load)		6		mS
Dynamic Load Response		50-100-50% load step, settling time to within ±2% of Vout di/dt = 2.5 A/μSec		60	90	μSec
Dynamic Load Peak Deviation		same as above		±200	±300	mV
FEATURES and OPTIONS						
Remote On/Off Control ⑤						
"N" suffix:						
Negative Logic, ON state		Pin open=ON	0		0.4	V
Negative Logic, OFF state			1.5		+Vin	V
Control Current		open collector/drain		1		mA
"P" suffix:						
Positive Logic, ON state		Pin open=ON	1		+Vin	V
Positive Logic, OFF state			0		0.4	V
Control Current		open collector/drain		1		mA

### FUNCTIONAL SPECIFICATIONS, OKX-T/5-W5-C (CONT.)

OUTPUT	Conditions ①	Minimum	Typical/Nominal	Maximum	Units
<b>Total Output Power</b>		0	16.5	16.83	W
<b>Voltage</b>					
<b>Nominal Output Voltage Range ③</b>	See trim formula	0.7525		3.6	Vdc
<b>Setting Accuracy</b>	At 50% load	-2		2	% of Vnom.
<b>Output Voltage Overshoot - Startup:</b>				1	%Vo nom
<b>Current</b>					
<b>Output Current Range</b>		0	5	5	A
<b>Minimum Load</b>			No minimum load		
<b>Current Limit Inception ⑥</b>	98% of Vnom., after warmup @1.8Vout	6	7.5	14.5	A
<b>Short Circuit</b>					
<b>Short Circuit Current ⑦</b>	Hiccup technique, autorecovery within ±1% of Vout		0.2		A
<b>Short Circuit Duration (remove short for recovery)</b>	Output shorted to ground, no damage		Continuous		
<b>Short circuit protection method</b>	Current limiting				
<b>Regulation ⑩</b>					
<b>Total Regulation Band</b>	Over all line, load and temp conditions	-4	Vo set	4	% Vo set
<b>Line Regulation</b>	Vin=min. to max. Vout=nom.			±0.25	%
<b>Load Regulation</b>	Iout=min. to max. Vin=48V.			±0.5	%
<b>Ripple and Noise ⑧</b>	3.3Vo, 5Vin			80	mV pk-pk
<b>Ripple and Noise</b>	1.8Vo, 5Vin			60	mV pk-pk
<b>Ripple and Noise</b>	1Vo, 5Vin			40	mV pk-pk
<b>Temperature Coefficient</b>	At all outputs		±0.02		% of Vnom./°C
<b>Maximum Capacitive Loading ④</b>	low ESR; >0.001, <0.01 ohm		1000		uF
<b>Maximum Capacitive Loading</b>	0.01 ohm		3000		uF
<b>MECHANICAL (Through Hole Models)</b>					
<b>Outline Dimensions</b>			0.40x0.90x0.282		Inches
			10.2x22.9x8.85		mm
<b>Weight</b>			0.1		Ounces
			2.8		Grams
<b>ENVIRONMENTAL</b>					
<b>Operating Ambient Temperature Range ⑨</b>	Full power, all output voltages, see derating curves	-40		85	°C
<b>Operating PCB Temperature ⑩</b>	No derating	-40		100	°C
<b>Storage Temperature</b>	Vin = Zero (no power)	-55		125	°C
<b>Thermal Protection/Shutdown</b>	Measured in center	130	130	135	°C
<b>Electromagnetic Interference</b>					
<b>Conducted, EN55022/CISPR22</b>	External filter is required		B		Class
<b>Radiated, EN55022/CISPR22</b>			B		Class

### Notes

- ① Specifications are typical at +25 deg.C, Vin=nominal (+5V), Vout=nominal (+3.3V), full load, external caps and natural convection unless otherwise indicated. Extended tests at higher power must supply substantial forced airflow. All models are tested and specified with external 1 uF paralleled with 10 uF ceramic output capacitors and a 22 uF external input capacitor. All capacitors are low ESR types. These capacitors are necessary to accommodate our test equipment and may not be required to achieve specified performance in your applications. However, Murata Power Solutions recommends installation of these capacitors. All models are stable and regulate within spec under no-load conditions.
- ② Input Back Ripple Current is tested and specified over a 5 Hz to 20 MHz bandwidth. Input filtering is Cin=2 x 100 uF tantalum, Cbus=1000 uF electrolytic, Lbus=1 uH.
- ③ Note that Maximum Power Derating curves indicate an average current at nominal input voltage. At higher temperatures and/or lower airflow, the DC/DC converter will tolerate brief full current outputs if the total RMS current over time does not exceed the Derating curve.
- ④ Mean Time Before Failure is calculated using the Telcordia (Belcore) SR-332 Method 1, Case 3, ISSUE 2, ground fixed controlled conditions, Tambient=+25 deg.C, full output load, natural air convection. (
- ⑤ The On/Off Control Input should use either a switch or an open collector/open drain transistor referenced to -Input Common. A logic gate may also be used by applying appropriate external voltages which not exceed +Vin.
- ⑥ Short circuit shutdown begins when the output voltage degrades approximately 1% from the selected setting.
- ⑦ "Hiccup" overcurrent operation repeatedly attempts to restart the converter with a brief, full-current output. If the overcurrent condition still exists, the restart current will be removed and then tried again. This short current pulse prevents overheating and damaging the converter. Once the fault is removed, the converter immediately recovers normal operation.
- ⑧ Output noise may be further reduced by adding an external filter. At zero output current, the output may contain low frequency components which exceed the ripple specification. The output may be operated indefinitely with no load.
- ⑨ All models are fully operational and meet published specifications, including "cold start" at -40°C.
- ⑩ Regulation specifications describe the deviation as the line input voltage or output load current is varied from a nominal midpoint value to either extreme.
- ⑪ Other input or output voltage ranges will be reviewed under scheduled quantity special order.
- ⑫ Maximum PC board temperature is measured with the sensor in the center of the converter.
- ⑬ Do not exceed maximum power specifications when adjusting the output trim.
- ⑭ The maximum output capacitive loads depend on the the Equivalent Series Resistance (ESR) of the external output capacitor and, to a lesser extent, the distance and series impedance to the load. Larger caps will reduce output noise but may change the transient response. Newer ceramic caps with very low ESR may require lower capacitor values to avoid instability. Thoroughly test your capacitors in the application. Please refer to the Output Capacitive Load Application Note.
- ⑮ Do not allow the input voltage to degrade lower than the input undervoltage shutdown voltage at all times. Otherwise, you risk having the converter turn off. The undervoltage shutdown is not latching and will attempt to recover when the input is brought back into normal operating range.
- ⑯ The outputs are not intended to sink appreciable reverse current.

**PERFORMANCE DATA, OKX-T/5-W5-C**

Efficiency vs. Line Voltage and Load Current @ +25°C  
(V<sub>OUT</sub> = 3.3V)

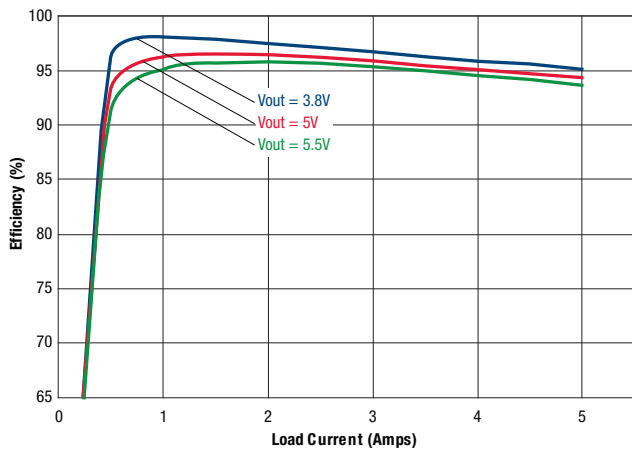

Efficiency vs. Line Voltage and Load Current @ +25°C  
(V<sub>OUT</sub> = 2.5V)

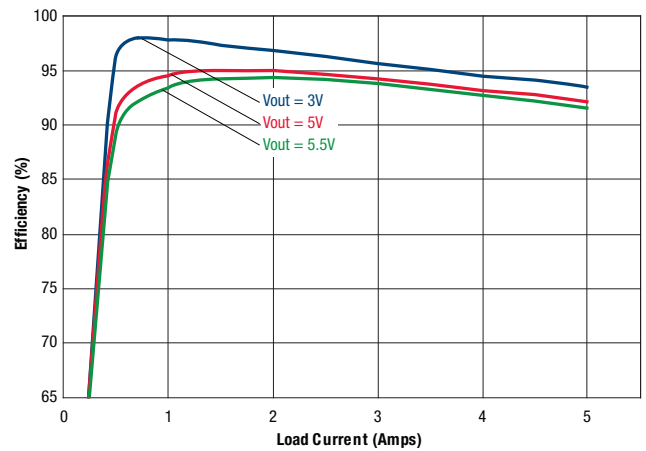

Efficiency vs. Line Voltage and Load Current @ +25°C  
(V<sub>OUT</sub> = 1.8V)

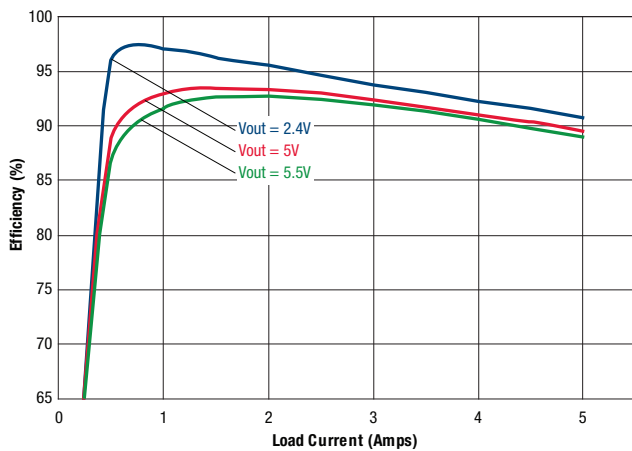

Efficiency vs. Line Voltage and Load Current @ +25°C  
(V<sub>OUT</sub> = 1.5V)

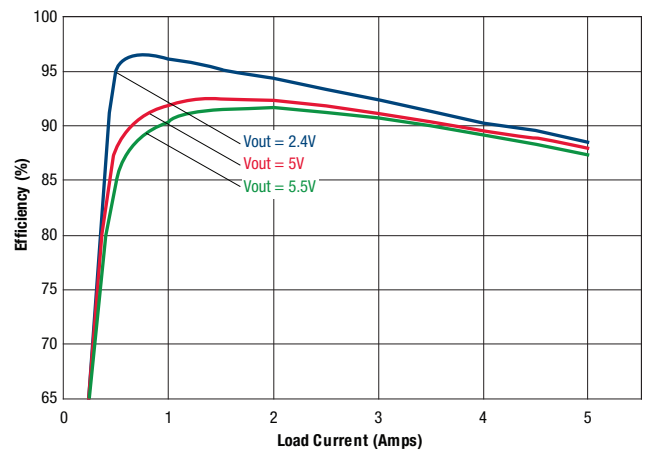

Efficiency vs. Line Voltage and Load Current @ +25°C  
(V<sub>OUT</sub> = 1.2V)

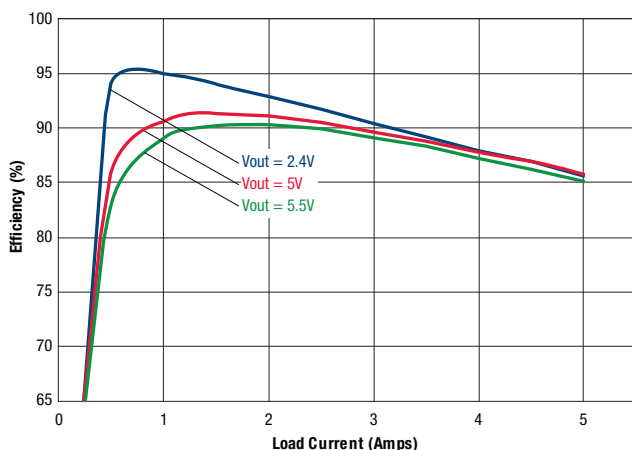

Efficiency vs. Line Voltage and Load Current @ +25°C  
(V<sub>OUT</sub> = 1.0V)

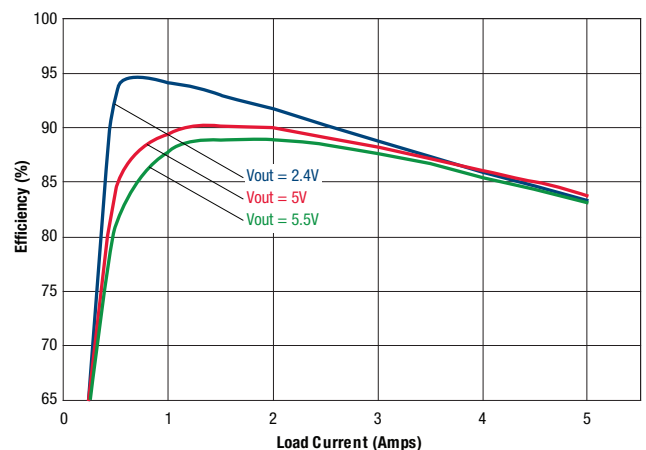

**PERFORMANCE DATA, OKX-T/5-W5-C**

Maximum Current Temperature Derating at Sea Level  
 (For Vin = min. to 5V, Vout = 1V to 2.5V; Vin = 3.8V, Vout = 3.3V; Vin = 5V, Vout = 3.3V)

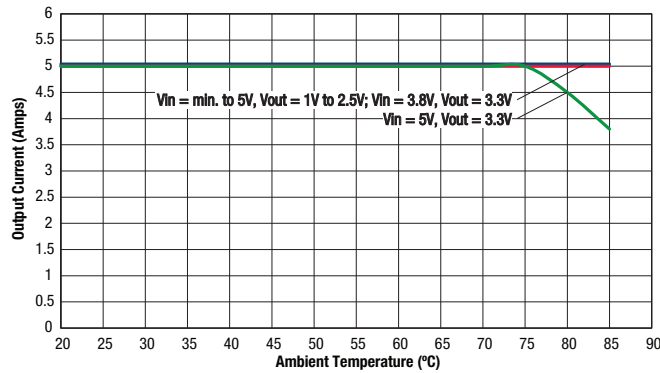

Start-up Delay (Vin=5V, Vout=3.3V, Iout=5A, Load= 1uF || 10uF, Cin22uF, Ta=+25°C)  
 Trace1= Vin, Trace2=Vout

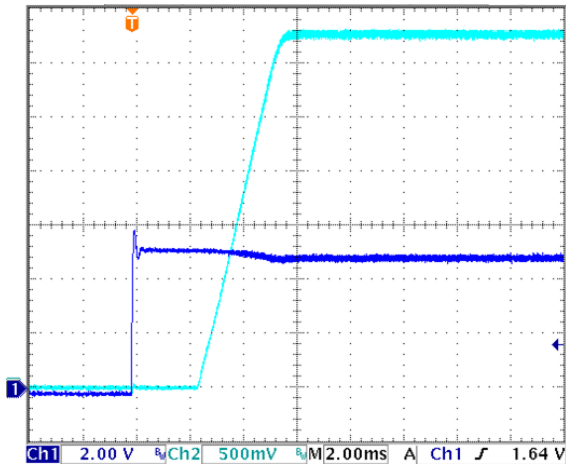

Start-up Delay (Vin=5V, Vout=3.3V, Iout=0A, Load= 1uF || 10uF, Cin22uF, Ta=+25°C)  
 Trace1= Vin, Trace2=Vout

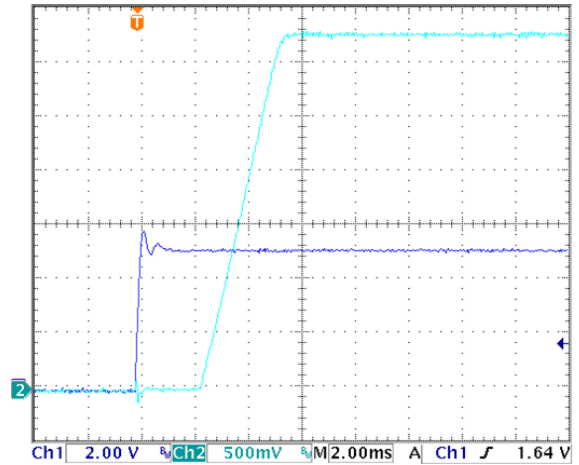

Start-up by Control pin (Vin=5V, Vout=3.3V, Iout=5A, Ta=+25°C) Trace1=Vin, Trace2=Control pin, Trace3=Vout

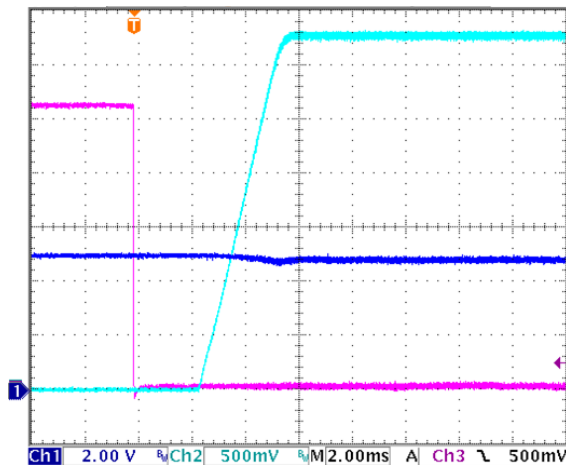

**PERFORMANCE DATA, OKX-T/5-W5-C**

Start-up Delay (Vin=5V, Vout=1V, Iout=5A, Cload= 1uF || 10uF, Cin22uF, Ta=+25°C) Trace1= Vin, Trace2=Vout

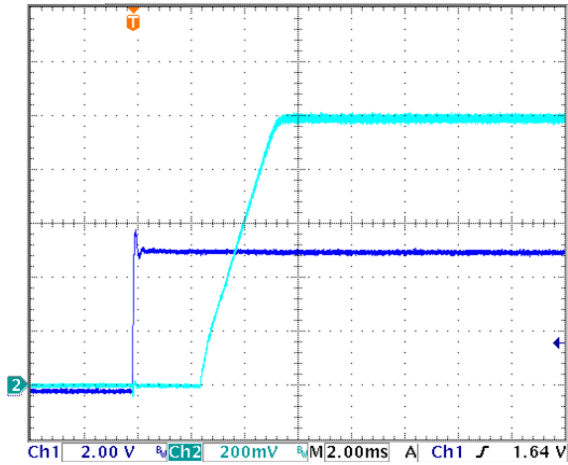

Step Load Transient Response (Vin=5V, Vout=3.3V, Iout=50-100-50% load (2.5A/us), Ta=+25°C)

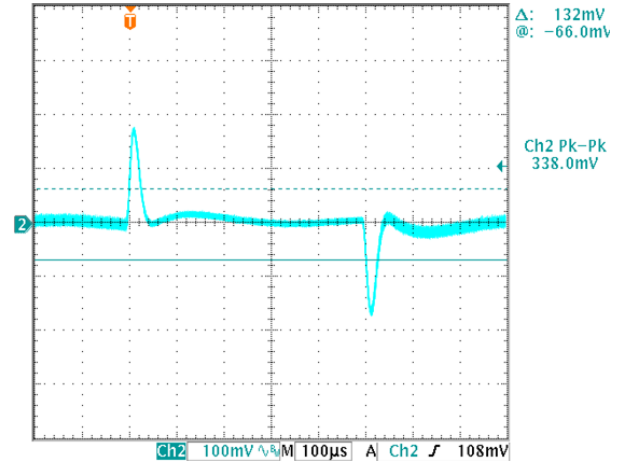

Step Load Transient Response (Vin=3.8V, Vout=3.3V, Iout=50-100-50% load (2.5A/us), Ta=+25°C)

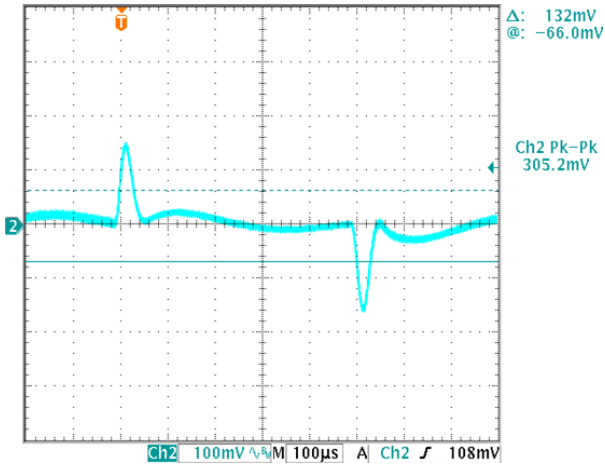

Step Load Transient Response (Vin=5V, Vout=1V, Iout=50-100-50% load (2.5A/us), Ta=+25°C)

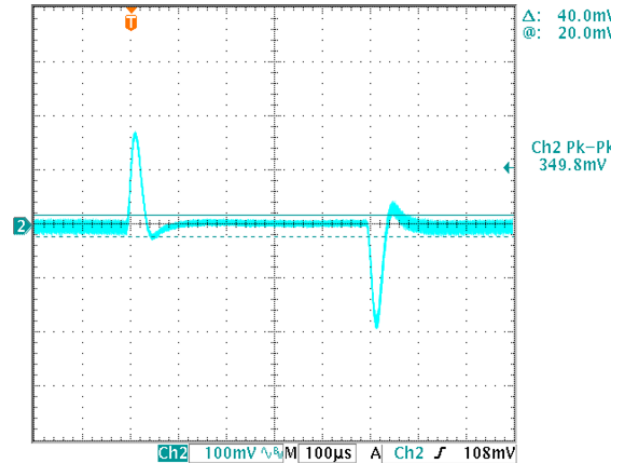

Output Ripple and Noise (Vin=5V, Iout=5A, Vout=3.3V, Cout= 1uF || 10uF, Ta=+25°C)

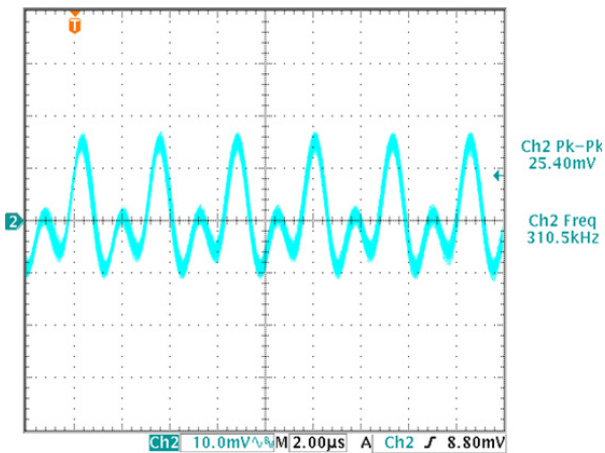

Output Ripple and Noise (Vin=5V, Iout=0A, Vout=3.3V, Cout= 1uF || 10uF, Ta=+25°C)

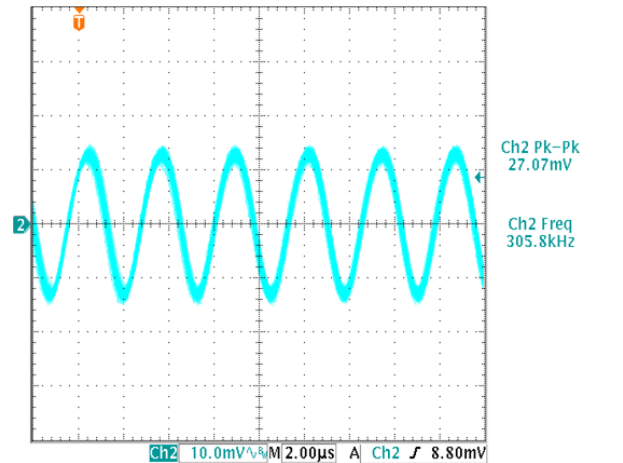

**PERFORMANCE DATA, OKX-T/5-W5-C**

Output Ripple and Noise (Vin=5V, Iout=5A, Vout=1.8V, Cout= 1uf || 10uF, Ta=+25°C)

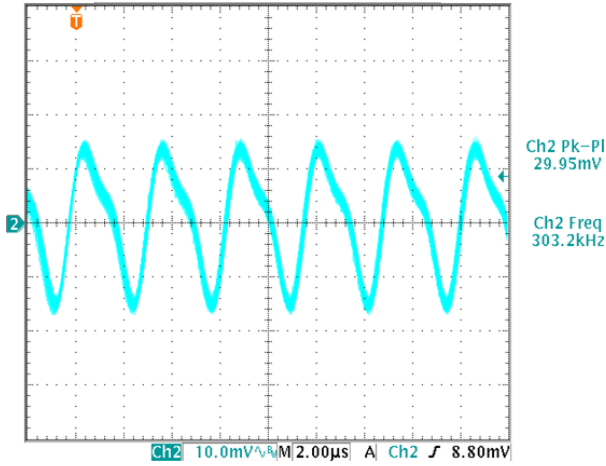

Output Ripple and Noise (Vin=5V, Iout=5A, Vout=1V, Cout= 1uf || 10uF, Ta=+25°C)

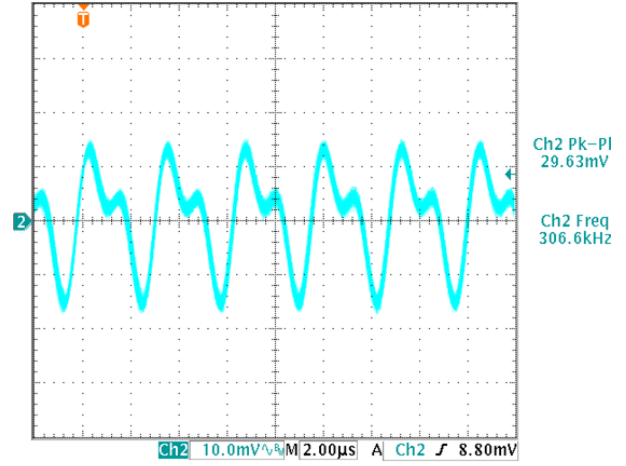



**MECHANICAL SPECIFICATIONS**

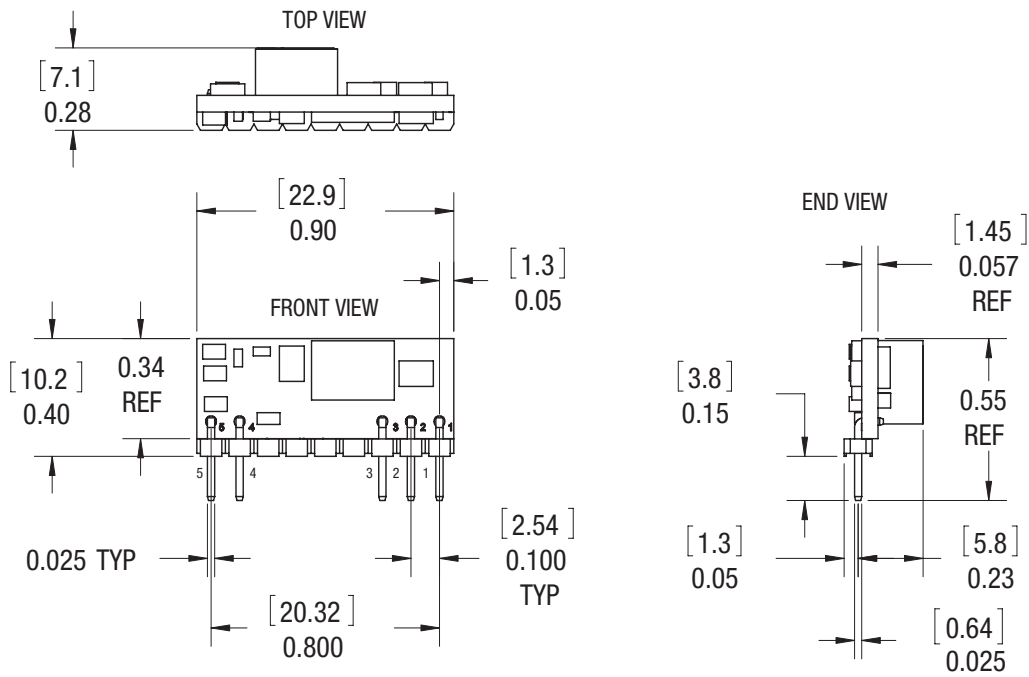

Dimensions are in mm [inches] shown for ref. only.

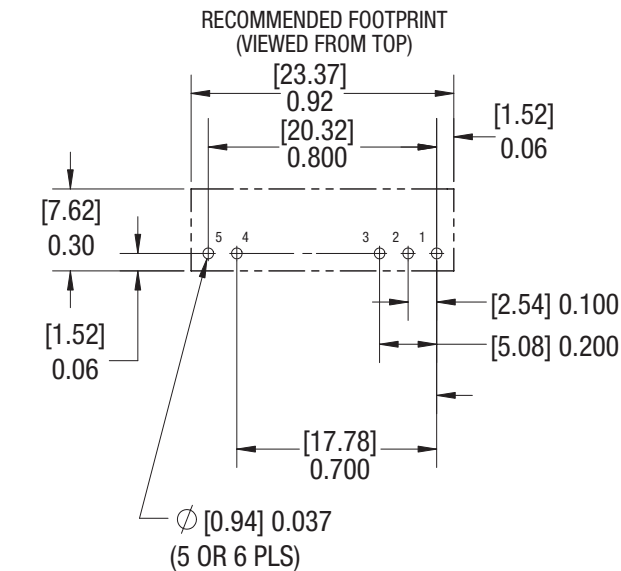

ISOMETRIC VIEW (REF ONLY)

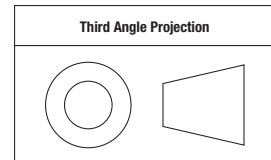
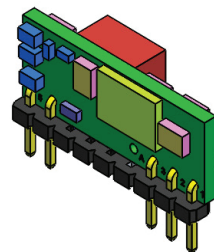

Tolerances (unless otherwise specified):  
 .XX ± 0.02 (0.5)  
 .XXX ± 0.010 (0.25)  
 Angles ± 1°

Components are shown for reference only.

**I/O CONNECTIONS**

Pin	Function
1	+Vout
2	Trim
3	Gnd (Common)
4	+Vin
5	Remote On/Off

\*The Remote On/Off can be provided with either positive (P) or negative (N) polarity.

**STANDARD PACKAGING**

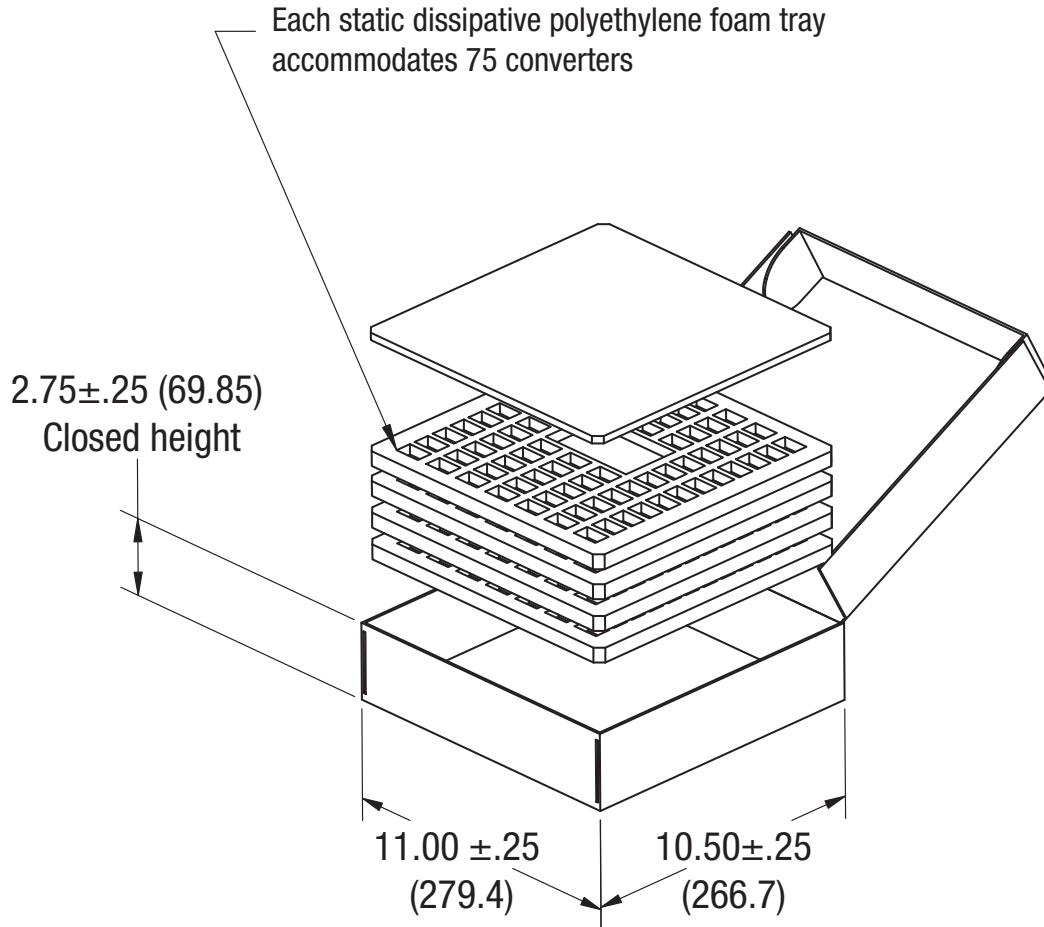

Carton accommodates four (4) trays of 75 yielding 300 converters per carton.

Dimensions are in inches (mm shown for ref. only).

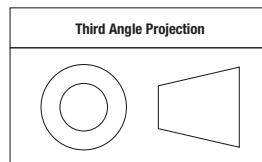

Tolerances (unless otherwise specified):

.XX ± 0.02 (0.5)

.XXX ± 0.010 (0.25)

Angles ± 1°

Components are shown for reference only.

**TECHNICAL NOTES**

**Input Fusing**

Certain applications and/or safety agencies may require fuses at the inputs of power conversion components. Fuses should also be used when there is the possibility of sustained input voltage reversal which is not current-limited. For greatest safety, we recommend a fast blow fuse installed in the ungrounded input supply line.

The installer must observe all relevant safety standards and regulations. For safety agency approvals, install the converter in compliance with the end-user safety standard, i.e. IEC/EN/UL 60950-1.

**Input Under-Voltage Shutdown and Start-Up Threshold**

Under normal start-up conditions, converters will not begin to regulate properly until the ramping-up input voltage exceeds and remains at the Start-Up Threshold Voltage (see Specifications). Once operating, converters will not turn off until the input voltage drops below the Under-Voltage Shutdown Limit. Subsequent restart will not occur until the input voltage rises again above the Start-Up Threshold. This built-in hysteresis prevents any unstable on/off operation at a single input voltage.

Users should be aware however of input sources near the Under-Voltage Shutdown whose voltage decays as input current is consumed (such as poorly regulated capacitor inputs), the converter shuts off and then restarts as the external capacitor recharges. Such situations could oscillate. To prevent this, make sure the operating input voltage is well above the UV Shutdown voltage AT ALL TIMES.

**Start-Up Time**

Assuming that the output current is set at the rated maximum, the Vin to Vout Start-Up Time (see Specifications) is the time interval between the point when the ramping input voltage crosses the Start-Up Threshold and the fully loaded regulated output voltage enters and remains within its specified regulation band. Actual measured times will vary with input source impedance, external input capacitance, input voltage slew rate and final value of the input voltage as it appears at the converter.

These converters include a soft start circuit to moderate the duty cycle of its PWM controller at power up, thereby limiting the input inrush current.

The On/Off Remote Control interval from On command to Vout regulated assumes that the converter already has its input voltage stabilized above the Start-Up Threshold before the On command. The interval is measured from the On command until the output enters and remains within its specified accuracy band. The specification assumes that the output is fully loaded at maximum rated current. Similar conditions apply to the On to Vout regulated specification such as external load capacitance and soft start circuitry.

**Recommended Input Filtering**

The user must assure that the input source has low AC impedance to provide dynamic stability and that the input supply has little or no inductive content, including long distributed wiring to a remote power supply. The converter will operate with no additional external capacitance if these conditions are met.

For best performance, we recommend installing a low-ESR capacitor immediately adjacent to the converter's input terminals. The capacitor should be a ceramic type such as the Murata GRM32 series or a polymer type. Initial suggested capacitor values are 10 to 22  $\mu$ F, rated at twice the expected maximum input voltage. Make sure that the input terminals do not go below the undervoltage shutdown voltage at all times. More input bulk capacitance may be added in parallel (either

electrolytic or tantalum) if needed.

**Recommended Output Filtering**

The converter will achieve its rated output ripple and noise with no additional external capacitor. However, the user may install more external output capacitance to reduce the ripple even further or for improved dynamic response. Again, use low-ESR ceramic (Murata GRM32 series) or polymer capacitors. Initial values of 10 to 47  $\mu$ F may be tried, either single or multiple capacitors in parallel. Mount these close to the converter. Measure the output ripple under your load conditions.

Use only as much capacitance as required to achieve your ripple and noise objectives. Excessive capacitance can make step load recovery sluggish or possibly introduce instability. Do not exceed the maximum rated output capacitance listed in the specifications.

**Input Ripple Current and Output Noise**

All models in this converter series are tested and specified for input reflected ripple current and output noise using designated external input/output components, circuits and layout as shown in the figures below. The Cbus and Lbus components simulate a typical DC voltage bus. Please note that the values of Cin, Lbus and Cbus may vary according to the specific converter model.

**Minimum Output Loading Requirements**

All models regulate within specification and are stable under no load to full load conditions. Operation under no load might however slightly increase output ripple

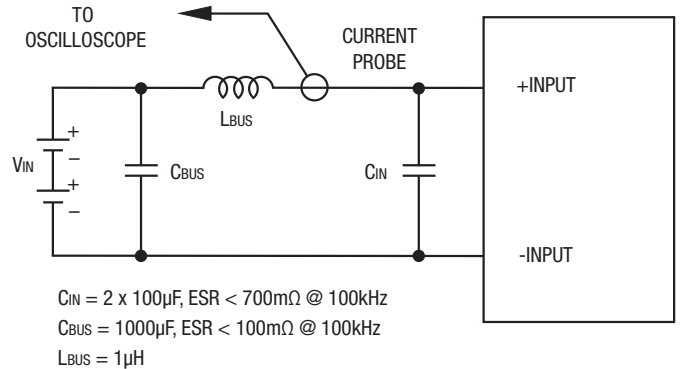

Figure 2. Measuring Input Ripple Current

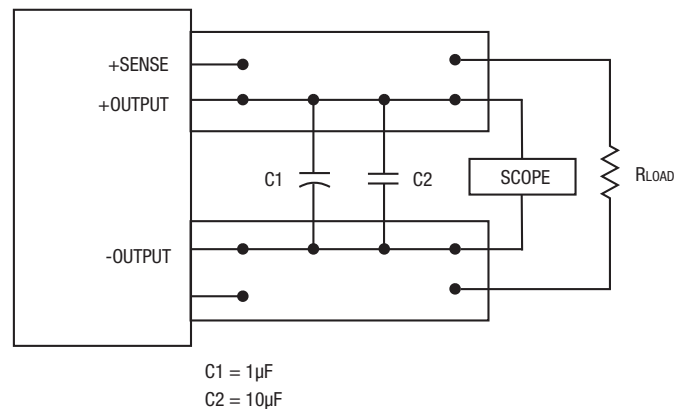

Figure 3. Measuring Output Ripple and Noise (PARD)

and noise.

### Thermal Shutdown

To prevent many over temperature problems and damage, these converters include thermal shutdown circuitry. If environmental conditions cause the temperature of the DC/DC's to rise above the Operating Temperature Range up to the shutdown temperature, an on-board electronic temperature sensor will power down the unit. When the temperature decreases below the turn-on threshold, the converter will automatically restart. There is a small amount of temperature hysteresis to prevent rapid on/off cycling.

**CAUTION:** If you operate too close to the thermal limits, the converter may shut down suddenly without warning. Be sure to thoroughly test your application to avoid unplanned thermal shutdown.

### Temperature Derating Curves

The graphs in this data sheet illustrate typical operation under a variety of conditions. The Derating curves show the maximum continuous ambient air temperature and decreasing maximum output current which is acceptable under increasing forced airflow measured in Linear Feet per Minute ("LFM"). Note that these are AVERAGE measurements. The converter will accept brief increases in current or reduced airflow as long as the average is not exceeded.

Note that the temperatures are of the ambient airflow, not the converter itself which is obviously running at higher temperature than the outside air. Also note that very low flow rates (below about 25 LFM) are similar to "natural convection," that is, not using fan-forced airflow.

Murata Power Solutions makes Characterization measurements in a closed cycle wind tunnel with calibrated airflow. We use both thermocouples and an infrared camera system to observe thermal performance.

**CAUTION:** If you routinely or accidentally exceed these Derating guidelines, the converter may have an unplanned Over Temperature shut down. Also, these graphs are all collected at slightly above Sea Level altitude. Be sure to reduce the derating for higher density altitude.

### Output Current Limiting

Current limiting inception is defined as the point at which full power falls below the rated tolerance. See the Performance/Functional Specifications. Note particularly that the output current may briefly rise above its rated value in normal operation as long as the average output power is not exceeded. This enhances reliability and continued operation of your application. If the output current is too high, the converter will enter the short circuit condition.

### Output Short Circuit Condition

When a converter is in current-limit mode, the output voltage will drop as the output current demand increases. If the output voltage drops too low (approximately 98% of nominal output voltage for most models), the PWM controller will shut down. Following a time-out period, the PWM will restart, causing the output voltage to begin ramping up to its appropriate value. If the short-circuit condition persists, another shutdown cycle will initiate. This rapid on/off cycling is called "hiccup mode". The hiccup cycling reduces the average output current, thereby preventing excessive internal temperatures and/or component damage. A short circuit can be tolerated indefinitely.

### Remote On/Off Control

The remote On/Off Control can be ordered with either polarity. Please refer to the Connection Diagram on page 1 for On/Off connections.

Positive polarity models are enabled when the On/Off pin is left open or is pulled high to +Vin with respect to -Vin. Therefore, the On/Off control can be disconnected if the converter should always be on. Positive-polarity devices are disabled when the On/Off is grounded or brought to within a low voltage (see Specifications) with respect to -Vin.

Negative polarity devices are on (enabled) when the On/Off pin is left open or brought to within a low voltage (see Specifications) with respect to -Vin. The device is off (disabled) when the On/Off is pulled high (see Specifications) with respect to -Vin.

Dynamic control of the On/Off function must sink appropriate signal current when brought low and withstand appropriate voltage when brought high. Be aware too that there is a finite time in milliseconds (see Specifications) between the time of On/Off Control activation and stable, regulated output. This time will vary slightly with output load type and current and input conditions.

### Output Capacitive Load

These converters do not require external capacitance added to achieve rated specifications. Users should only consider adding capacitance to reduce switching noise and/or to handle spike current load steps. Install only enough capacitance to achieve your noise and surge response objectives. Excess external capacitance may cause regulation problems and possible oscillation or instability. Proper wiring of the Sense inputs will improve these factors under capacitive load.

The maximum rated output capacitance and ESR specification is given for a capacitor installed immediately adjacent to the converter. Any extended output wiring, smaller wire gauge or less ground plane may tolerate somewhat higher capacitance. Also, capacitors with higher ESR may use a larger capacitance.

### Pre-Biased Startup

Some sections have external power already partially applied (possibly because of earlier power sequencing) before POL power up. Or leakage power is present so that the DC/DC converter must power up into an existing output voltage. This power may either be stored in an external bypass capacitor or supplied by an active source. These converters include a pre-bias startup mode to prevent initialization problems.

This "pre-biased" condition can also occur with some types of programmable logic or because of blocking diode leakage or small currents passed through forward biased ESD diodes. This feature is variously called "monotonic" because the voltage does not decay or produce a negative transient once the input power is applied and startup begins.

**Output Voltage Adjustment**

The output voltage may be adjusted over a limited range by connecting an external trim resistor (Rtrim) between the Trim pin and Ground. The Rtrim resistor is recommended to have a ±0.5% accuracy (or better) with low temperature coefficient, ±100 ppm/°C or better. Mount the resistor close to the converter with very short leads or use a surface mount trim resistor.

In the tables below, the calculated resistance is given. Do not exceed the specified limits of the output voltage or the converter’s maximum power rating when applying these resistors. Also, avoid high noise at the Trim input. However, to prevent instability, you should never connect any capacitors to Trim.

**Soldering Guidelines**

Murata Power Solutions recommends the specifications below when installing these converters. These specifications vary depending on the solder type. Exceeding these specifications may cause damage to the product. Your production environment may differ; therefore please thoroughly review these guidelines with your process engineers.

Wave Solder Operations for through-hole mounted products (THMT)	
<b>For Sn/Ag/Cu based solders:</b>	
Maximum Preheat Temperature	115° C.
Maximum Pot Temperature	270° C.
Maximum Solder Dwell Time	7 seconds
<b>For Sn/Pb based solders:</b>	
Maximum Preheat Temperature	105° C.
Maximum Pot Temperature	250° C.
Maximum Solder Dwell Time	6 seconds

Murata Power Solutions, Inc.  
129 Flanders Rd. Westborough, Ma 01581, USA.  
ISO 9001 and 14001 REGISTERED

**OKX-T/5-W5**

Output Voltage	Calculated Rtrim (KΩ)
3.3 V.	3.160
2.5 V.	6.947
1.8 V.	15.004
1.5 V.	23.077
1.2 V.	41.973
1.0 V.	80.021
0.7525 V.	∞ (open)

**Resistor Trim Equation:**

$$R_{TRIM} (\Omega) = \frac{21070}{V_{OUT} - 0.7525V} - 5110$$

**Product Label**

Because of the small size of these products, the product label contains a character-reduced code to indicate the model number and manufacturing date code. Not all items on the label are always used. Please note that the label differs from the product photograph on page 1. Here is the layout of the label:

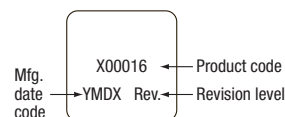

Figure 4. Label Artwork Layout

The label contains three rows of information:

- First row – Murata Power Solutions logo
- Second row – Model number product code (see table)
- Third row – Manufacturing date code and revision level

Model Number	Product Code
OKX-T/5-W5N-C	X00005
OKX-T/5-W5P-C	X01005

The manufacturing date code is four characters:

- First character – Last digit of manufacturing year, example 2009
- Second character – Month code (1 through 9 and 0 through D)
- Third character – Day code (1 through 9 = 1 to 9, 10 = 0 and 11 through 31 = A through Z)
- Fourth character – Manufacturing information



**This product is subject to the following operating requirements and the Life and Safety Critical Application Sales Policy: Refer to: <https://www.murata-ps.com/requirements/>**

Murata Power Solutions, Inc. makes no representation that the use of its products in the circuits described herein, or the use of other technical information contained herein, will not infringe upon existing or future patent rights. The descriptions contained herein do not imply the granting of licenses to make, use, or sell equipment constructed in accordance therewith. Specifications are subject to change without notice.  
© 2021 Murata Power Solutions, Inc.