

**SERIES:** PQA50-D | **DESCRIPTION:** DC-DC CONVERTER

**FEATURES**

- up to 50 W isolated output
- 2:1 input range (18~36 Vdc, 36~75 Vdc)
- smaller package
- single, regulated output
- 1,500 Vdc isolation
- short circuit, over current, input under voltage protection
- remote on/off
- operating temperature range (-40~85°C)
- six sided metal shielding
- efficiency up to 93%
- EN 62368-1



MODEL	input voltage		output voltage (Vdc)	output current		output power max (W)	ripple and noise <sup>1</sup> max (mVp-p)	efficiency typ (%)
	typ (Vdc)	range (Vdc)		min (mA)	max (A)			
PQA50-D24-S3-D	24	18~36	3.3	500	10	33	150	91
PQA50-D24-S5-D	24	18~36	5	500	10	50	150	93
PQA50-D24-S12-D	24	18~36	12	208	4.167	50	150	93
PQA50-D24-S15-D	24	18~36	15	167	3.333	50	150	93
PQA50-D24-S24-D	24	18~36	24	104	2.083	50	150	93
PQA50-D48-S3-D	48	36~75	3.3	500	10	33	150	91
PQA50-D48-S5-D	48	36~75	5	500	10	50	150	93
PQA50-D48-S12-D	48	36~75	12	208	4.167	50	150	93
PQA50-D48-S15-D	48	36~75	15	167	3.333	50	150	93
PQA50-D48-S24-D	48	36~75	24	104	2.083	50	150	93

Notes: 1. Ripple and noise are measured at 20 MHz BW by "parallel cable" method with 1 µF ceramic and 10 µF electrolytic capacitors on the output.

**PART NUMBER KEY**

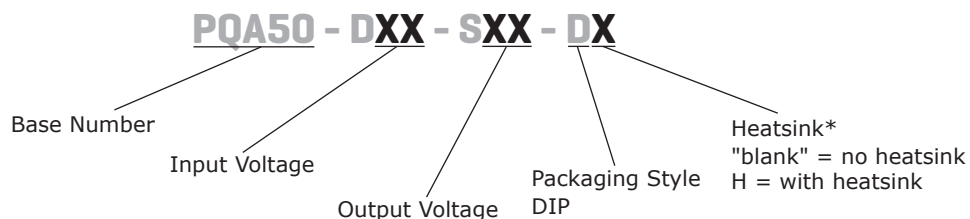

Notes: \*Discontinued heatsink versions.

## INPUT

parameter	conditions/description	min	typ	max	units
operating input voltage	24 Vdc input models	18	24	36	Vdc
	48 Vdc input models	36	48	75	Vdc
start-up voltage	input under voltage protection				
	24 Vdc input models	18			Vdc
	48 Vdc input models	36			Vdc
	input over voltage protection				
under/over voltage shutdown	24 Vdc input models			36	Vdc
	48 Vdc input models			75	Vdc
	input under voltage protection				
	24 Vdc input models			16	Vdc
surge voltage	48 Vdc input models			32	Vdc
	input over voltage protection				
	24 Vdc input models	40			Vdc
start-up time	48 Vdc input models	81			Vdc
	for maximum of 1 second				
	24 Vdc input models	-0.7		50	Vdc
CTRL <sup>1</sup>	48 Vdc input models	-0.7		100	Vdc
	nominal input, constant load		10		ms
filter	models ON (CTRL open or connect TTL high level, 3~12 Vdc)				
	models OFF (CTRL connect GND or low level, 0~1.2 Vdc)				
	input current (models OFF)		6		mA
filter	pi filter				

Note 1. CTRL pin voltage is referenced to GND.

## OUTPUT

parameter	conditions/description	min	typ	max	units
line regulation	full load, input voltage from low to high		±0.2	±0.5	%
load regulation	10% to 100% load		±0.5	±1	%
voltage accuracy			±1	±3	%
adjustability			±10		%
switching frequency	PWM mode		300		kHz
transient recovery time	25% load step change		300	500	µs
transient response deviation	25% load step change		±3	±5	%
temperature coefficient	100% load		±0.02		%/°C

## PROTECTIONS

parameter	conditions/description	min	typ	max	units
over voltage protection <sup>2</sup>	3.3 Vdc output models		3.9		Vdc
	5 Vdc output models		6.2		Vdc
	12 Vdc output models		15		Vdc
	15 Vdc output models		18		Vdc
	24 Vdc output models		30		Vdc
over current protection			135		%
short circuit protection	continuous, automatic recovery, hiccup				
over temperature protection			110		°C

Note 2. Module needs to be re-started after over voltage protection.

## SAFETY AND COMPLIANCE

parameter	conditions/description	min	typ	max	units
isolation voltage	input to output at 1 mA for 1 minute	1,500			Vdc
isolation resistance	input to output at 500 Vdc	1,000			MΩ
isolation capacitance	input to output at 100 kHz, 0.1 Vdc		2,000		pF
safety approvals	certified to 62368: CE				
conducted emissions	CISPR22/EN55022 class B (external circuit required, see figure 1)				
radiated emissions	CISPR22/EN55022 class B (external circuit required, see figure 1)				
ESD	IEC/EN61000-4-2 class B, contact ± 4kV				
radiated immunity	IEC/EN61000-4-3 class A, 10V/m				
EFT/burst	IEC/EN61000-4-4 class B, ± 2kV (external circuit required, see figure 1)				
surge	IEC/EN61000-4-5 class B, ± 2kV (external circuit required, see figure 1)				
conducted immunity	IEC/EN61000-4-6 class A, 3 Vr.m.s				
voltage dips & interruptions	IEC/EN61000-4-29 class B, 0%-70%				
MTBF	as per MIL-HDBK-217F @ 25°C	1,000,000			hours
RoHS	2011/65/EU				

## ENVIRONMENTAL

parameter	conditions/description	min	typ	max	units
operating temperature	see derating curve	-40		85	°C
storage temperature		-55		125	°C
storage humidity	non-condensing	5		95	%
case temperature	at full load, operating temperature curve range			105	°C
vibration	10~55 Hz, 30 min. along x, y, and z			10	G

## SOLDERABILITY

parameter	conditions/description	min	typ	max	units
hand soldering	1.5 mm from case for 10 seconds			300	°C
wave soldering	see wave soldering profile			260	°C

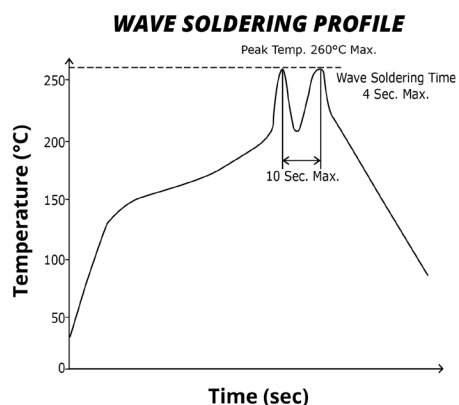

## MECHANICAL

parameter	conditions/description	min	typ	max	units
dimensions	board mount: 50.80 x 25.40 x 11.80 board mount with heatsink: 50.80 x 25.40 x 16.30				mm mm
case material	aluminum alloy				
weight	board mount board mount with heatsink		35 43		g g

## MECHANICAL DRAWING

### BOARD MOUNT

units: mm[inch]

tolerance:  $\pm 0.30[\pm 0.012]$

pin diameter tolerance:  $\pm 0.10[\pm 0.004]$

pin height tolerance:  $\pm 0.50[\pm 0.020]$

PIN CONNECTIONS	
PIN	Function
1	Vin
2	GND
3	Ctrl
4	Trim
5	0V
6	+Vo

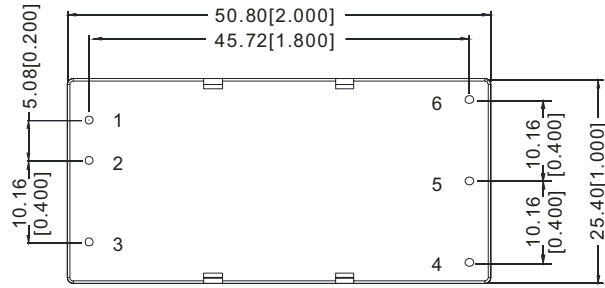

Bottom View

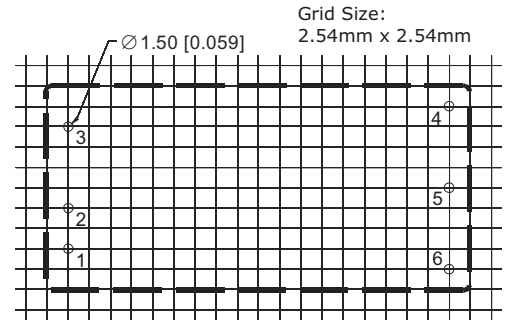

PCB Layout  
Top View

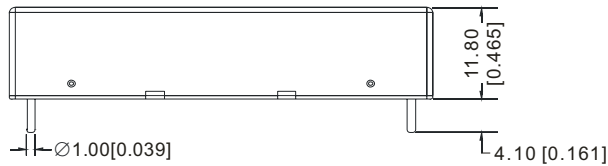

Front View

### BOARD MOUNT WITH HEATSINK

units: mm[inch]

tolerance:  $\pm 0.30[\pm 0.012]$

pin diameter tolerance:  $\pm 0.10[\pm 0.004]$

pin height tolerance:  $\pm 0.50[\pm 0.020]$

PIN CONNECTIONS	
PIN	Function
1	Vin
2	GND
3	Ctrl
4	Trim
5	0V
6	+Vo

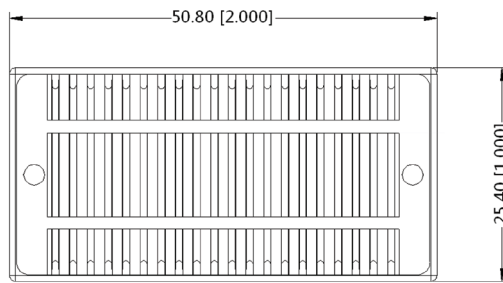

Top View

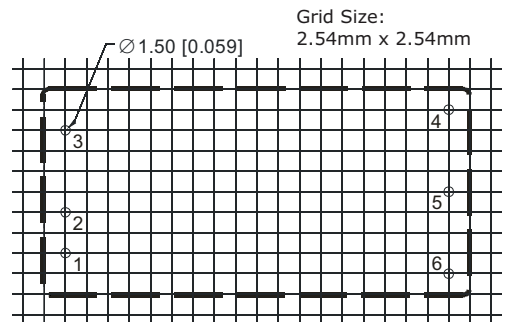

PCB Layout  
Top View

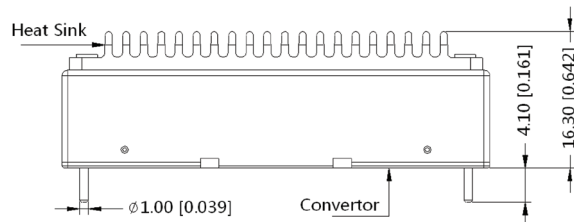

Front View

## DERATING CURVES

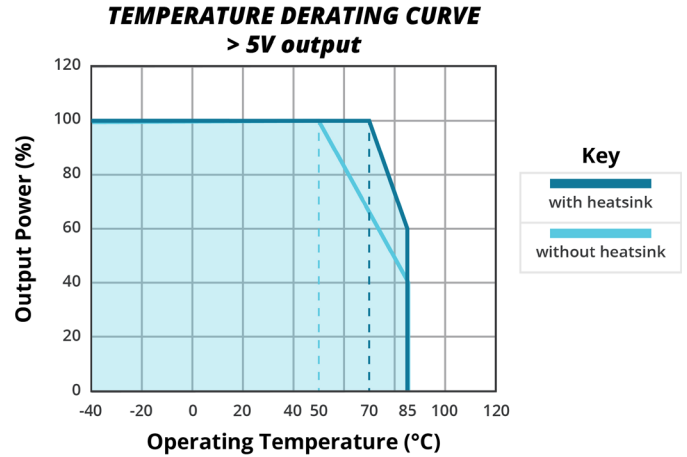
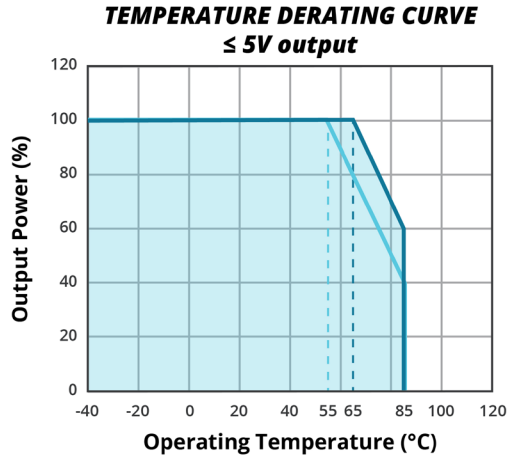

## EMC RECOMMENDED CIRCUIT

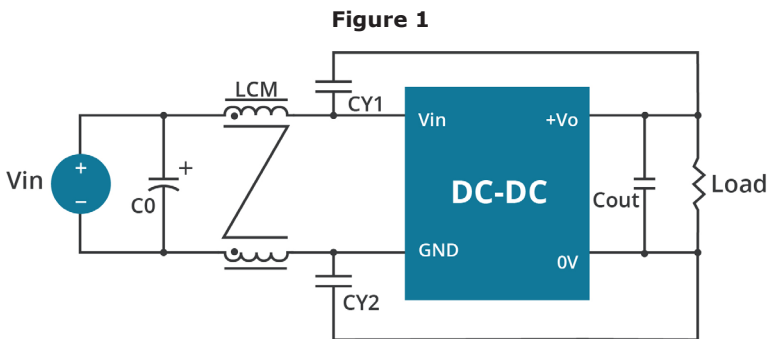
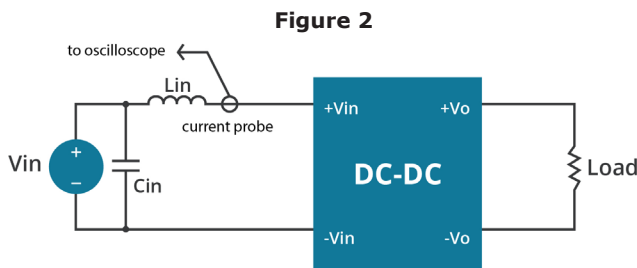

**Table 1**

Recommended external circuit components		
Vin (Vdc)	24	48
C0	330µF/50V	330µF/100V
CY1, CY2	1nF/2kV	1nF/2kV
LCM	2.2mH	2.2mH

Note: 1. See Table 3 for Cout values.

## TEST CONFIGURATION



**Table 2**

External components	
Lin	4.7µH
Cin	220µF, ESR < 1.0Ω at 100 kHz

Note: 1. Input reflected-ripple current is measured with an inductor Lin and Capacitor Cin to simulate source impedance.

## APPLICATION NOTES

### 1. Requirement on output load

To ensure this module can operate efficiently and reliably, the minimum output load cannot be less than 5% of the full load during operation. If the actual output power is small, please connect a resistor at the output end in parallel to increase the load.

### 2. Recommended circuit

This series has been tested according to the following recommended testing circuit before leaving the factory. This series should be tested under load (see Figure 3). If you want to further decrease the input/output ripple, you can increase capacitance properly or choose capacitors with low ESR (see table 3). However, the capacitance must not exceed the maximum capacitive load or a start-up problem might arise (see table 4).

Figure 3

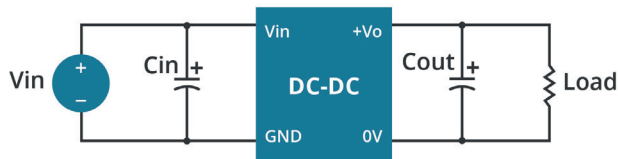

Table 3

Vout (Vdc)	Cin (μF)	Cout (μF)
3.3	100	220
5	100	220
12	100	100
15	100	100
24	100	47

Table 4

Vout (Vdc)	Max. Capacitive Load (μF)
3.3	27000
5	18900
12	3700
15	2000
24	1000

### 3. Output Voltage Trimming

Leave open if not used.

Figure 4

Application Circuit for Trim Pin  
(part in broken line is the interior of models)

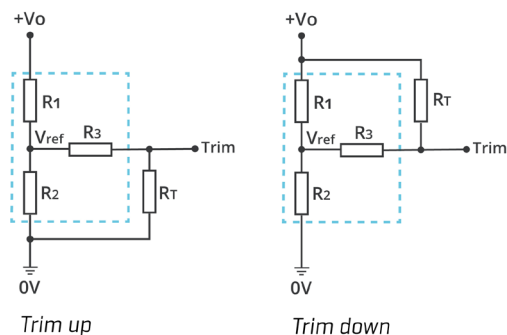

Formula for Trim Resistor

$$\text{up: } R_T = \frac{aR_2}{R_2 - a} - R_3 \quad a = \frac{V_{ref}}{V_o' - V_{ref}} \cdot R_1$$

$$\text{down: } R_T = \frac{aR_1}{R_1 - a} - R_3 \quad a = \frac{V_o' - V_{ref}}{V_{ref}} \cdot R_2$$

Note: Value for R1, R2, R3, and Vref (see Table 5)  
 RT: Trim Resistor  
 a: User-defined parameter, no actual meanings  
 Vo': The trim up/down voltage

Table 5

Vout (Vdc)	R1 (kΩ)	R2 (kΩ)	R3 (kΩ)	Vref (V)
3.3	4.788	2.87	15	1.24
5	2.87	2.87	12.1	2.5
12	11	2.87	22	2.5
15	15	3	22	2.5
24	20	2.308	15	2.5

Notes: 1. Minimum load shouldn't be less than 5%, otherwise ripple may increase dramatically. Operation under minimum load will not damage the converter, however, they may not meet all specifications listed.  
 2. Maximum capacitive load is tested at input voltage range and full load.  
 3. All specifications are measured at Ta=25°C, humidity<75%, nominal input voltage and rated output load unless otherwise specified.

## REVISION HISTORY

rev.	description	date
1.0	initial release	07/01/2013
1.01	added heat sink option, updated spec	10/29/2013
1.02	updated datasheet	07/14/2015
1.03	discontinued heat sink versions	02/07/2019
1.04	company logo updated	03/30/2021
1.05	derating curves and circuit figures updated	01/05/2022

The revision history provided is for informational purposes only and is believed to be accurate.



**CUI INC**  
a bel group

**Headquarters**  
20050 SW 112th Ave.  
Tualatin, OR 97062  
**800.275.4899**

Fax 503.612.2383  
**cui.com**  
techsupport@cui.com

CUI offers a two (2) year limited warranty. Complete warranty information is listed on our website.

CUI reserves the right to make changes to the product at any time without notice. Information provided by CUI is believed to be accurate and reliable. However, no responsibility is assumed by CUI for its use, nor for any infringements of patents or other rights of third parties which may result from its use.

CUI products are not authorized or warranted for use as critical components in equipment that requires an extremely high level of reliability. A critical component is any component of a life support device or system whose failure to perform can be reasonably expected to cause the failure of the life support device or system, or to affect its safety or effectiveness.