

SERIES: VOF-45 | DESCRIPTION: AC-DC POWER SUPPLY
FEATURES

- up to 45 W continuous power
- industry standard footprint
- universal input (85~264 Vac)
- single output from 3.3~48 V
- user trimmable output voltage
- 3000 V isolation
- over current, over voltage, and short circuit protections
- UL/cUL and TUV 60950-1 safety approvals
- efficiency up to 88%



MODEL	output voltage	output current	output power	ripple ¹ and noise	efficiency
	(Vdc)	max (A)	max (W)	max (mVp-p)	typ (%)
VOF-45-3.3	3.3	6.0	20	50	74
VOF-45-5	5	6.0	30	50	78
VOF-45-7.5	7.5	5.0	38	75	78
VOF-45-9	9	4.4	40	90	82
VOF-45-12	12	3.7	44	120	84
VOF-45-15	15	3.0	45	150	85
VOF-45-24	24	1.9	46	240	86
VOF-45-48	48	0.93	45	480	88

Notes: 1. Ripple & noise are measured at 20 MHz BW with 0.1 μ F ceramic cap and a 10 μ F electrolytic capacitors on the output and the two earth ground pads are connected to input earth ground.

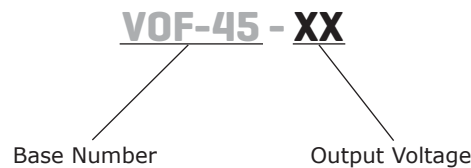
PART NUMBER KEY

INPUT

parameter	conditions/description	min	typ	max	units
voltage		85		264	Vac
		120		375	Vdc
frequency		47		63	Hz
input current	110 Vac		1		A
	220 Vac		0.5		A
inrush current	110 Vac, full load, cold start			25	A
	220 Vac, full load, cold start			50	A
input fuse	built-in, non-user serviceable				

OUTPUT

parameter	conditions/description	min	typ	max	units
line regulation	high line to low line at full load		±0.5		%
load regulation	full load to 10% load		±1		%
temperature coefficient			±0.05		%/°C
hold-up time	115 Vac at full load	8			ms
adjustability	adjustable with built-in trim pot	-5		+5	%
switching frequency			60		kHz

OUTPUT

parameter	conditions/description	min	typ	max	units
over voltage protection	clamped by TVS			115	%
over current protection	automatically recovers		105		%Io
short circuit protection	protected, long term short circuit may reduce reliability				

SAFETY & COMPLIANCE

parameter	conditions/description	min	typ	max	units
isolation voltage	primary to secondary for 1 minute	3,000			Vac
	primary to transformer core for 1 minute	1,500			Vac
	primary to ground for 1 minute	1,500			Vac
isolation resistance	input to output at 500 Vdc at 25°C	50			MΩ
safety approvals	TUV EN 60950, CE, UL/cUL 60950-1				
EMI/EMC	FCC class B, EN 55022 class B				
leakage current				1.5	mA
RoHS compliant	yes				
MTBF	according to MIL-HDBK-217F	250,000			hours

ENVIRONMENTAL

parameter	conditions/description	min	typ	max	units
operating temperature	see derating curve	0		60	°C
storage temperature		-20		85	°C
operating humidity	non-condensing	20		90	%
storage humidity	non-condensing	20		95	%
operating altitude			10,000		ft
			3,000		m
storage altitude			30,000		ft
			9,000		m

DERATING CURVES

1. output power vs. ambient temperature
a. 3.3, 5, 7.5 V models

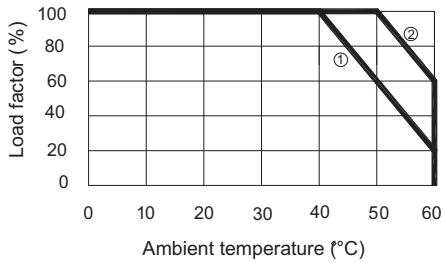

① Convection
② Forced air (0.5m³/min) (18 CFM)

b. all other models

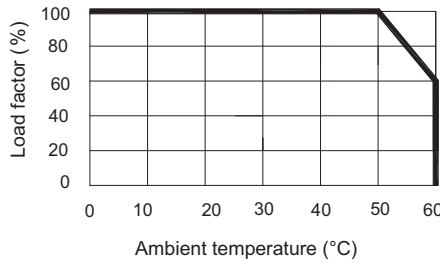

① Forced air (0.5m³/min) (18 CFM)

2. output power vs. input voltage
all models

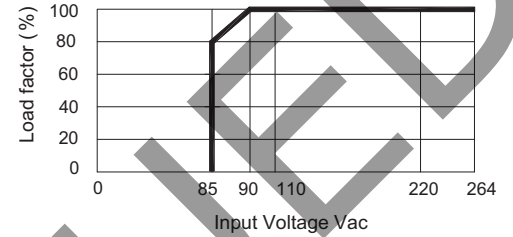

MATING CONNECTORS

parameter	conditions/description
ac input (CN1)	mates with Molex housing 09-50-3031 with Molex 2878 series crimp contact
dc output (CN2)	mates with Molex housing 09-50-3041 with Molex 2878 series crimp contact

MOUNTING METHOD

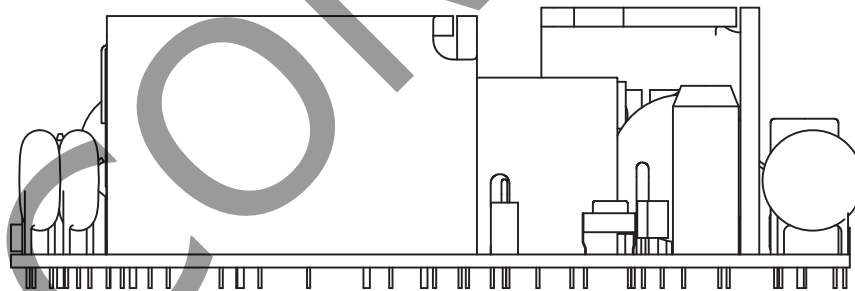

Horizontal

(performance evaluations conducted under this mounting method)

MECHANICAL

parameter	conditions/description	min	typ	max	units
dimensions	4 x 2 x 1.44 (102 x 51 x 36.6 mm)				inch
weight				0.17	kg
cooling method	free air convection or forced air				

MECHANICAL DRAWING

units: mm[inch]
tolerance: ±0.3[0.1]

CN1	
1	L
2	no pin
3	N

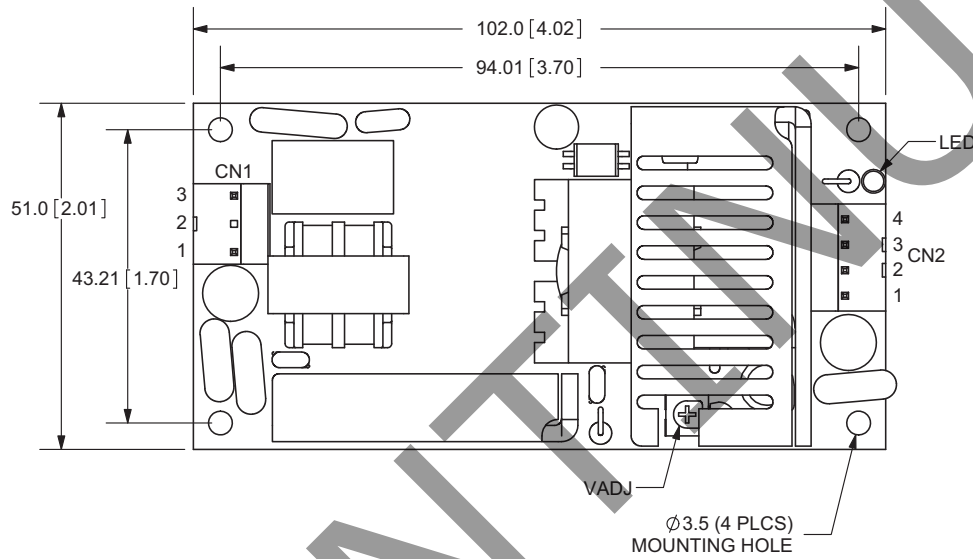

CN2	
1	-Vo
2	-Vo
3	+Vo
4	+Vo

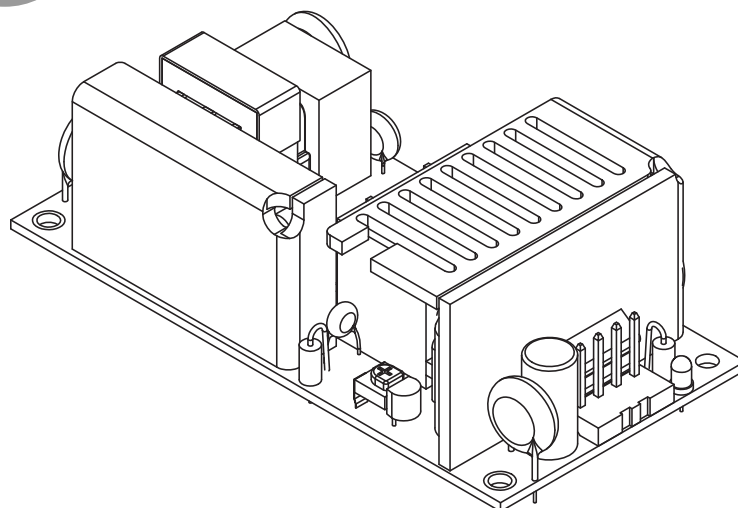
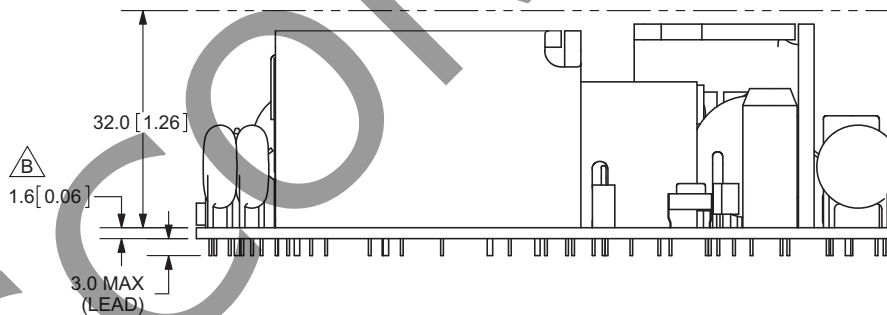

REVISION HISTORY

rev.	description	date
1.0	initial release	04/03/2009
1.01	dimension added to drawing	05/02/2011
1.02	new template applied	05/13/2011
1.03	added MTBF data	09/20/2011
1.04	V-Infinity branding removed	08/17/2012

The revision history provided is for informational purposes only and is believed to be accurate.



Headquarters
20050 SW 112th Ave.
Tualatin, OR 97062
800.275.4899

Fax 503.612.2383
cui.com
techsupport@cui.com

CUI offers a two (2) year limited warranty. Complete warranty information is listed on our website.

CUI reserves the right to make changes to the product at any time without notice. Information provided by CUI is believed to be accurate and reliable. However, no responsibility is assumed by CUI for its use, nor for any infringements of patents or other rights of third parties which may result from its use.

CUI products are not authorized or warranted for use as critical components in equipment that requires an extremely high level of reliability. A critical component is any component of a life support device or system whose failure to perform can be reasonably expected to cause the failure of the life support device or system, or to affect its safety or effectiveness.