



## SERIES: PSK-15B | DESCRIPTION: AC-DC POWER SUPPLY

### FEATURES

- up to 15 W continuous power
- universal input: 85~264 Vac
- compact encapsulated design
- single output from 5 Vdc ~ 48 Vdc
- short circuit, over voltage protection, over current protection
- 4000 Vac isolation
- no load power consumption <100 mW



MODEL	output voltage	output current	output power	ripple and noise <sup>1</sup>	efficiency
	(Vdc)	max (A)	max (W)	typ (mVp-p)	typ (%)
PSK-15B-S5	5	2.8	14	100	81.37
PSK-15B-S9	9	1.6	14.4	100	84.28
PSK-15B-S12	12	1.25	15	120	84.50
PSK-15B-S15	15	1	15	150	84.50
PSK-15B-S24	24	0.625	15	240	84.50
PSK-15B-S48	48	0.32	15.4	480	84.63

Notes: 1. At full load, nominal input, 20 MHz bandwidth oscilloscope, output terminated with 10  $\mu$ F electrolytic and 0.1  $\mu$ F ceramic capacitors.  
2. All specifications are measured at  $T_a=25^\circ\text{C}$ , nominal input voltage, and 75% rated output load unless otherwise specified.

### PART NUMBER KEY

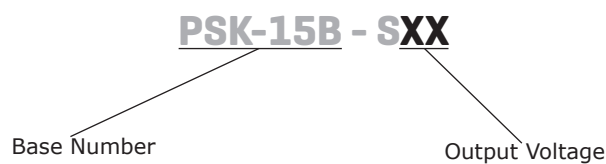

## INPUT

parameter	conditions/description	min	typ	max	units
voltage		85 120		264 370	Vac Vdc
frequency		47		63	Hz
current				0.4	A
inrush current	at 240 Vac, 25°C, cold start			60	A
leakage current				0.25	mA
no load power consumption				0.10	W

## OUTPUT

parameter	conditions/description	min	typ	max	units
capacitive load	5 Vdc output model			2,800	μF
	9 Vdc output model			1,600	μF
	12 Vdc output model			1,250	μF
	15 Vdc output model			1,000	μF
	24 Vdc output model			625	μF
	48 Vdc output model			320	μF
initial set point accuracy	at full load, 25°C		±2		%
line regulation	high line to low line at full load		±0.5		%
load regulation	10%~100% load		±1		%
hold-up time	at 115 Vac		12		ms
switching frequency			65		kHz
temperature coefficient			±0.05		%/°C

## PROTECTIONS

parameter	conditions/description	min	typ	max	units
over voltage protection	hiccup, auto recovery				
over current protection		110			%
short circuit protection	hiccup, auto recovery				

## SAFETY & COMPLIANCE

parameter	conditions/description	min	typ	max	units
isolation voltage	input to output		4,000		Vac
safety approvals	IEC62368-1/60950-1, UL62368-1/60950-1				
safety class	class II				
EMI/EMC	EN 55032 Class B, FCC Part 15 Class B, EN 61000-6-3, EN 61000-3-2, EN 61000-3-3, EN 55024, EN 61204-3, EN 61000-6-1				
MTBF	as per MIL-STD-217F, at 115 Vac, 25°C, GB	300,000			hours
life time	at 40°C, 75% load	3			years
RoHS	yes				

## ENVIRONMENTAL

parameter	conditions/description	min	typ	max	units
operating temperature	see derating curve	-25		70	°C
storage temperature		-40		85	°C
operating humidity	non-condensing			93	%
operating altitude			5000		m

## SOLDERABILITY

parameter	conditions/description	min	typ	max	units
wave soldering	see wave soldering profile			260	°C

- Notes:
1. Soldering materials: Sn/Cu/Ni
  2. Ramp up rate during preheat: 1.4°C/s (from 50°C to 100°C)
  3. Soaking temperature: 0.5°C/s (from 100°C to 130°C), 60±20 seconds
  4. Peak temperature: 260°C, above 250°C for 3~6 seconds
  5. Ramp down rate during cooling: -10°C/s (from 260°C to 150°C)

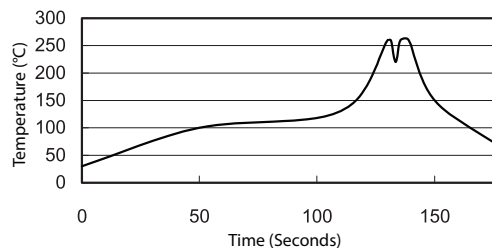

## MECHANICAL

parameter	conditions/description	min	typ	max	units
dimensions	2.440 x 1.770 x 0.909 (61.98 x 44.96 x 23.09 mm)				inch
weight			104		g
cooling	natural convection				

## MECHANICAL DRAWING

units: inch [mm]  
 tolerance: X.XXX = ±0.020 [±0.50]

PIN CONNECTIONS	
PIN	Function
1	ACN
2	ACL
3	-Vout
4	+Vout

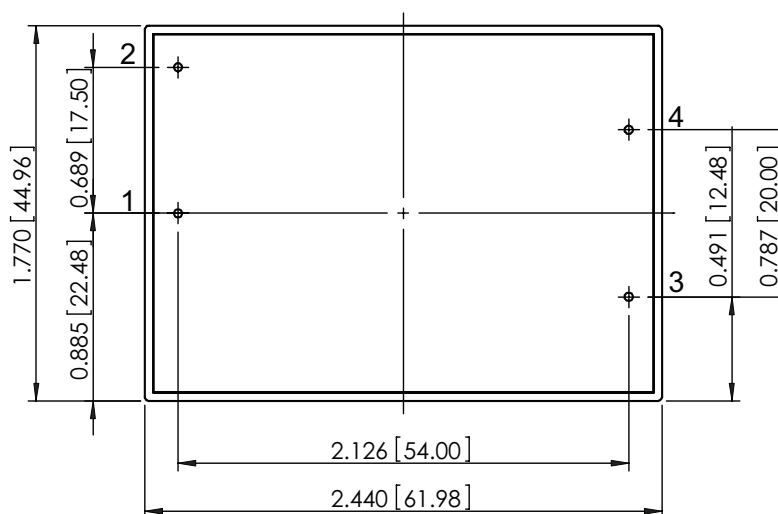
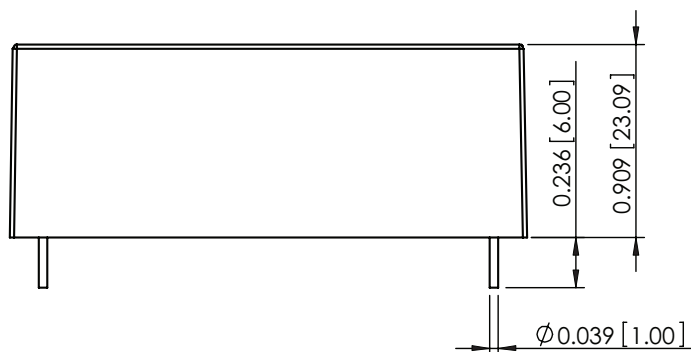

## DERATING CURVE

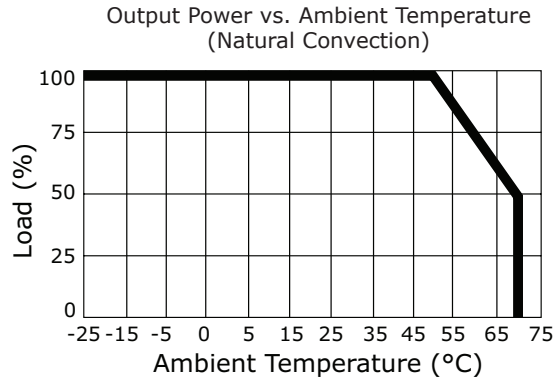

## EFFICIENCY CURVES

5 Vdc Output Efficiency Curve  
(at 25°C)

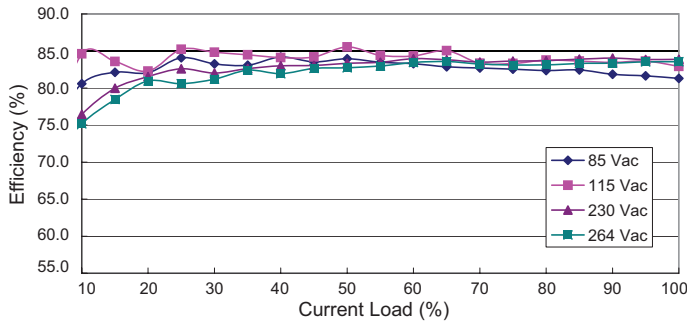

9 Vdc Output Efficiency Curve  
(at 25°C)

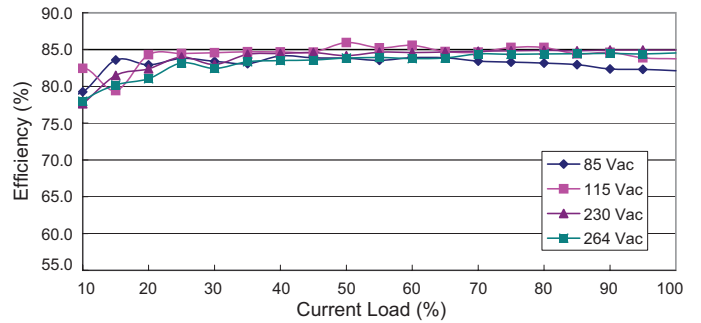

12 Vdc Output Efficiency Curve  
(at 25°C)

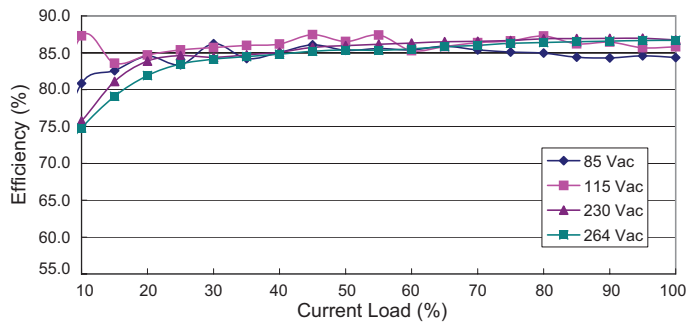

15 Vdc Output Efficiency Curve  
(at 25°C)

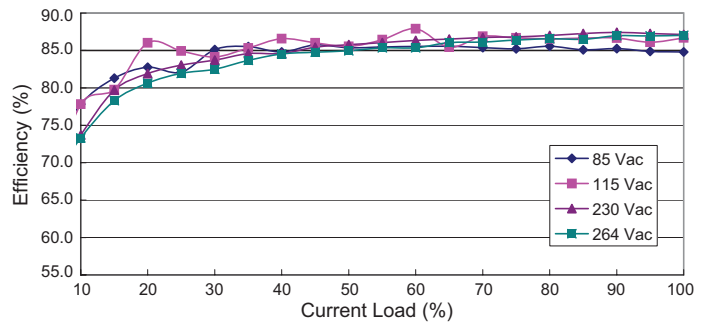

24 Vdc Output Efficiency Curve  
(at 25°C)

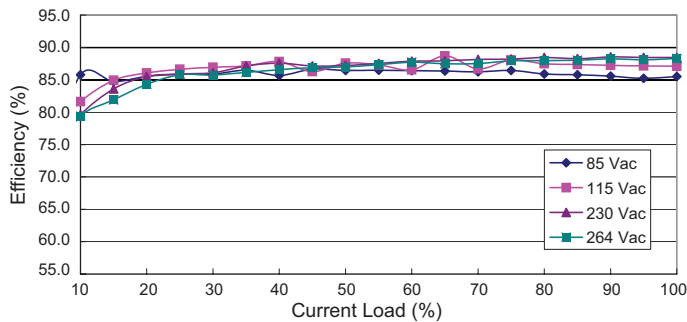

48 Vdc Output Efficiency Curve  
(at 25°C)

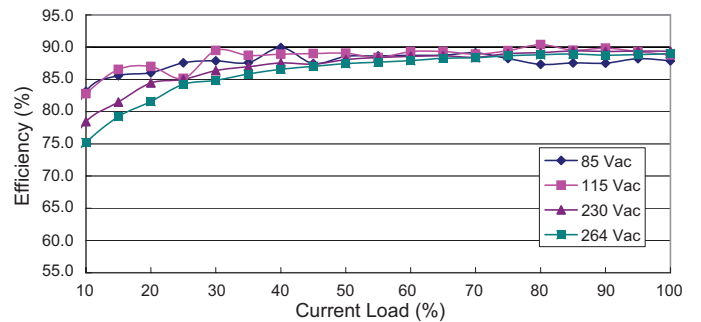

## REVISION HISTORY

---

rev.	description	date
1.0	initial release	02/23/2017
1.01	increased operating altitude	02/05/2018
1.02	updated datasheet	01/08/2019

The revision history provided is for informational purposes only and is believed to be accurate.



**Headquarters**  
20050 SW 112th Ave.  
Tualatin, OR 97062  
**800.275.4899**

Fax 503.612.2383  
**cui.com**  
techsupport@cui.com

CUI offers a two (2) year limited warranty. Complete warranty information is listed on our website.

CUI reserves the right to make changes to the product at any time without notice. Information provided by CUI is believed to be accurate and reliable. However, no responsibility is assumed by CUI for its use, nor for any infringements of patents or other rights of third parties which may result from its use.

CUI products are not authorized or warranted for use as critical components in equipment that requires an extremely high level of reliability. A critical component is any component of a life support device or system whose failure to perform can be reasonably expected to cause the failure of the life support device or system, or to affect its safety or effectiveness.