

1206红普绿 贴片式发光二极管



特点 (Characteristic) :

- * 外观尺寸 (L/W/H) :3.2*1.6*0.8mm
Outline Dimensions (L / w / h): 3.2x1.6x 0.8mm
- * 发光颜色及胶体: 高亮度红普绿双色/透明胶体
Luminous color and colloid: high brightness Red and Dreen / transparent colloid
- * 环保工艺符合ROHS标准
Environmental protection meets ROHS standard
- * EIA规范标准包装
EIA standard packaging
- * 适用于SMT贴片自动化生产
Suitable for automatic mounter
- * 适用于回流焊制程
Suitable for reflow soldering process

应用领域 (Product application) :

- * 医疗设备: 内窥镜、血氧仪
Medical equipment: endoscope、oximeter
- * 汽车电子: 背光按键灯、指示灯
Automotive electronics: backlight key light、indicator light
- * 工业产品: 电子仪表盘、工业设备
Industrial products: electronic instrument panel、industrial equipment
- * 智能家居: 白色家电、数码管LED
Smart home: white appliances, nixie tube LED
- * 通讯产品: 手机按键灯、路由器、电视盒
Communication products: mobile phone button lamp, router



目录

Catalogue

电性参数	
Electrical Characteristics.....	1
典型特性曲线	
Typical Characteristic Curves.....	2
可靠性实验	
Reliability Test Items And Conditions.....	3
外形尺寸	
Outline Dimensions.....	4
包装	
Packaging.....	5
焊接指导	
Guideline for Soldering.....	6
使用注意事项	
Precautions.....	7

电性参数

Electrical Characteristics

极限参数 (Ta=25℃) :

Limit parameters (TA = 25 °C):

项目 tem	符号 Symbol	最大额定值 Absolute Maximum Rating		单位 Unit
消耗功率 Consumed power	Pd	红Red	55	mW
		普绿Yellow green	55	
最大脉冲电流 (1/10占空比, 0.1ms脉宽) Maximum pulse current (1/10 duty cycle, 0.1ms pulse width)	IFP	红Red	100	mA
		普绿Yellow green	100	
正向直流工作电 流 Forward DC working current	IF	红Red	25	mA
		普绿Yellow green	25	
反向电压 Reverse voltage	VR	红Red	5	V
		普绿Yellow green	5	
工作环境温度 Working ambient temperature	Topr	-30°C ~ +85°C		
存储环境温度 Storage ambient temperature	Tstg	-40°C ~ +90°C		
焊接条件 Welding conditions	Tsol	回流焊 : 260°C , 10s 手动焊 : 300°C , 3s		
抗静电能力 Antistatic ability	ESD	2000		V

光电参数 Electro-Optical Characteristics (温度=25°C) (Temperature=25°C)

项目 Item	符号 Symbol	颜色 Colour	最小值 Min	代表值 Typ.	最大值 Max.	单位 Units	测试条件 Test Conditions
光强 light intensity	IV	红Red	/	44	/	mcd	IF = 5mA
		普绿yellow green	/	10	/		
半光强视角 Half light angle	2θ1/2	/	/	120	/	deg	IF = 5mA
峰值波长 Peak wavelength	λP	红Red	620	---	625	nm	IF = 5mA
		普绿yellow green	568	570	572		
主波长 Dominant wavelength	λD	红Red	620	/	630	nm	IF = 5mA
		普绿yellow green	565	/	575		
半波宽 Half width wave	Δλ	红Red	/	20	/	nm	IF=5mA
		普绿yellow green	/	15	/		
正向电压 Forward voltage	VF	红Red	1.7	/	21	V	IF=5mA
		普绿yellow green	1.7	/	2.1		
反向电流 Reverse current	IR	红Red	/	/	1	uA	VR=5V
		普绿yellow green	/	/	1		

备注: 1. 发光强度是由光纤和过滤器的组合测定的, 因此接近视觉感应曲线

Remarks: 1 The luminous intensity is measured by the combination of optical fiber and filter, so it is close to the visual induction curve

2. 半光强视角是轴向发光强度一半时的离轴角.

2. The angle of half light intensity is the off-axis angle when the axial luminous intensity is half

3. 主波长 λ d源自CIE色度图, 代表单一的波长, 它定义了器件的颜色

3. Main wavelength λ D is derived from CIE chromaticity diagram, representing a single wavelength, which defines the color of the device

亮度分档:**Brightness grading:**

颜色 Colour	代码 Code	最小值 Minimum value	最大值 Maximum	单位 Unit	测试条件 Test conditions
红色 Red	E53	37	59	mcd	IF=5mA
普绿 Yellow green	K25	8	11		

电压分档:**Voltage grading:**

颜色 Colour	代码 Code	最小值 Minimum value	最大值 Maximum	单位 Unit	测试条件 Test conditions
红色 Red	F4	1.9	2.1	V	IF=5mA
普绿 Yellow green	F4	1.9	2.1		

波长分档:**Wavelength grading:**

颜色 Colour	代码 Code	最小值 Minimum value	最大值 Maximum	单位 Unit	测试条件 Test conditions
红色 Red	HR21	619	624	nm	IF=5mA
普绿 Yellow green	HYG12	567	570		

可靠性试验

Reliability Test Items And Conditions

测试项目 Test item	测试条件 Test Conditions	测试次数 Number of tests	参考标准 Reference standard	失效判定标准 Failure criteria	失效LED数量 (PCS) Number of failed LEDs (PCS)
防潮等级 Moisture proof grade	1.回流焊最高温度=260℃,10秒, 2次回 流焊; 1. Maximum temperature of reflow soldering =260 °C, 10 seconds, 2 reflow soldering; 2.回流焊之前存储条 件: 30℃, 相对湿度 =70%, 168H; 2. Storage conditions before reflow soldering: 30 °C, relative humidity =70%, 168h;	-	JEITA ED-4701 300.301	# 1	0/22
焊接信赖性 (无铅回流焊) Welding reliability (lead free reflow soldering)	回流焊最高温度=245 ±5℃, 5秒 (无铅回 流焊) Maximum temperature of reflow soldering =245 ± 5 °C, 5 seconds (lead- free reflow soldering)	-	JEITA ED-4701 303 303A	# 2	0/22
冷热循环 thermal cycling	-40℃ 30分钟~25℃ 5分钟~ 100℃ 30分钟~25℃ 5分钟	300 个循环 300 cycles	JESD22- A104	# 1	0/22

冷热冲击 Thermal Shock	-35℃ 15分钟 转换时间3分钟 85℃ 15分钟 -35℃ for 15 minutes Conversion time 3 minutes 85℃ for 15 minutes	300 个循环 300 cycles	JESD22- A106	# 1	0/22
高温存储 High temperature storage	Ta=100℃	1000 小时 1000 hours	JESD22- A103	# 1	0/22
低温存储 Low temperature storage	Ta=-40℃	1000 小时 1000 hours	JESD22- A119	# 1	0/22
常温老化 Normal temperature aging	Ta=25℃ IF=20mA	1000小时 1000 hours	JESD22- A108	# 1	0/22

***1 失效判断标准 Criteria For Judging Damage**

标准# standard	测试项目 Test items	测试条件 Test conditions	判定标准 Judgment criteria
# 1	正向电压(V _F) Forward voltage (VF)	I _F =20mA	>U.S.L*1.1
	光强 (IV) Light intensity (IV)	I _F =20mA	<L.S.L*0.7
	反向电流(I _R) Reverse current (IR)	V _R =5V	>U.S.L*2.0
# 2	焊接可靠性 Welding reliability	/	锡膏覆盖焊盘比例小于95% The proportion of solder paste covering pad is less than 95%

*数据工作表中所示的技术信息仅限于典型特征和电路实例引用的产品.它既不构成工业特性的保证,也不构成任何许可的授权

The technical information shown in the data sheets are limited to the typical characteristics and circuit examples of the referenced products. It does not constitute the warranting of industrial property nor the granting of any license.

典型光电特性曲线

Typical optical characteristics curves

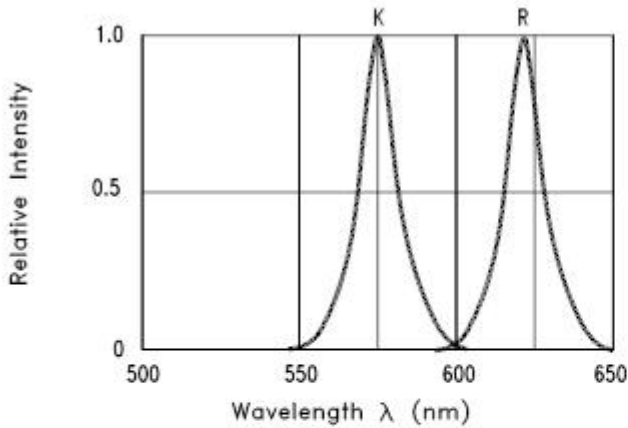

Fig.1 RELATIVE INTENSITY VS. WAVELENGTH

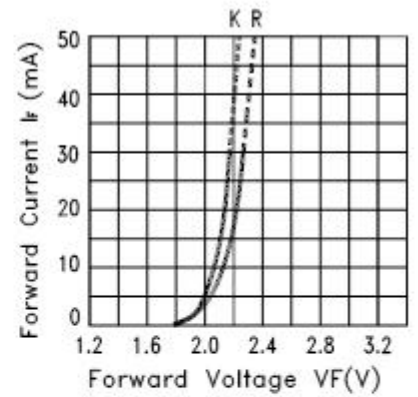

Fig.2 FORWARD CURRENT VS. FORWARD VOLTAGE

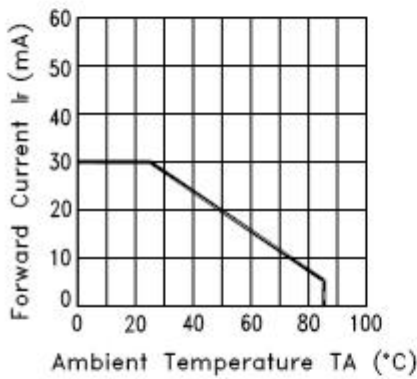

Fig.3 FORWARD CURRENT DERATING CURVE

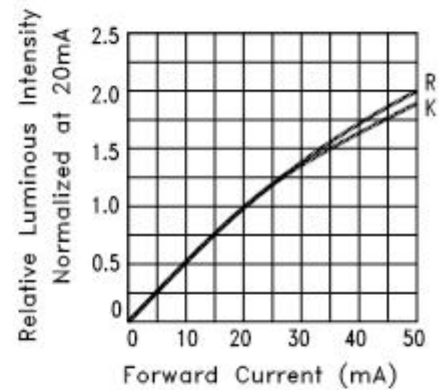

Fig.4 RELATIVE LUMINOUS INTENSITY VS. FORWARD CURRENT

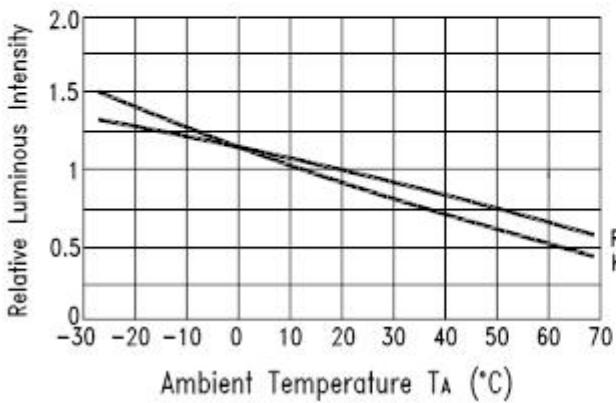

Fig.5 Luminous Intensity vs. Ambient Temperature

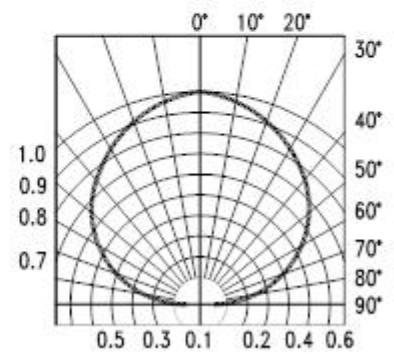
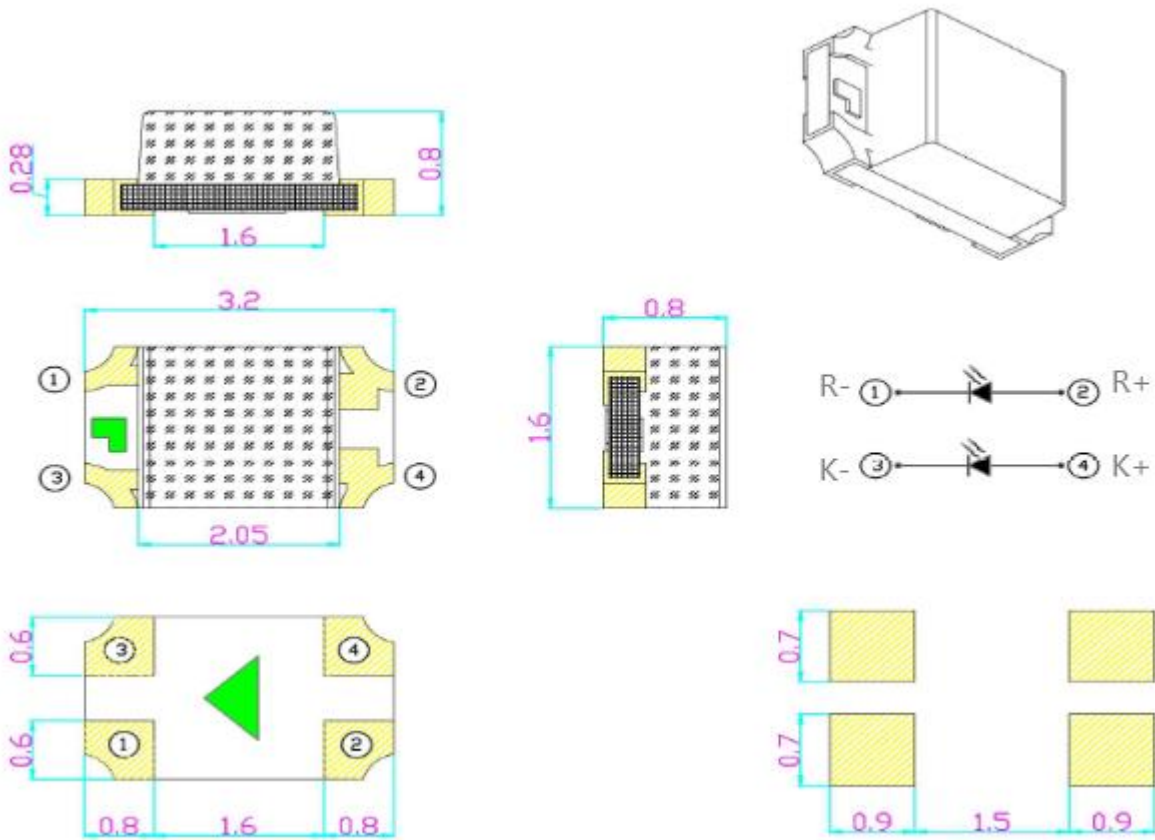

Fig.6 SPATIAL DISTRIBUTION

封装尺寸

Package Dimensions



建议焊盘尺寸

Recommended pad size

备注：1. 单位：毫米（mm）

Remarks: 1 Unit: mm

2.公差：如无特别标注则为± 0.10 mm

2. Tolerance: ± 0.10 mm unless otherwise specified

包装载带与圆盘尺寸

Packaging tape and disc dimensions

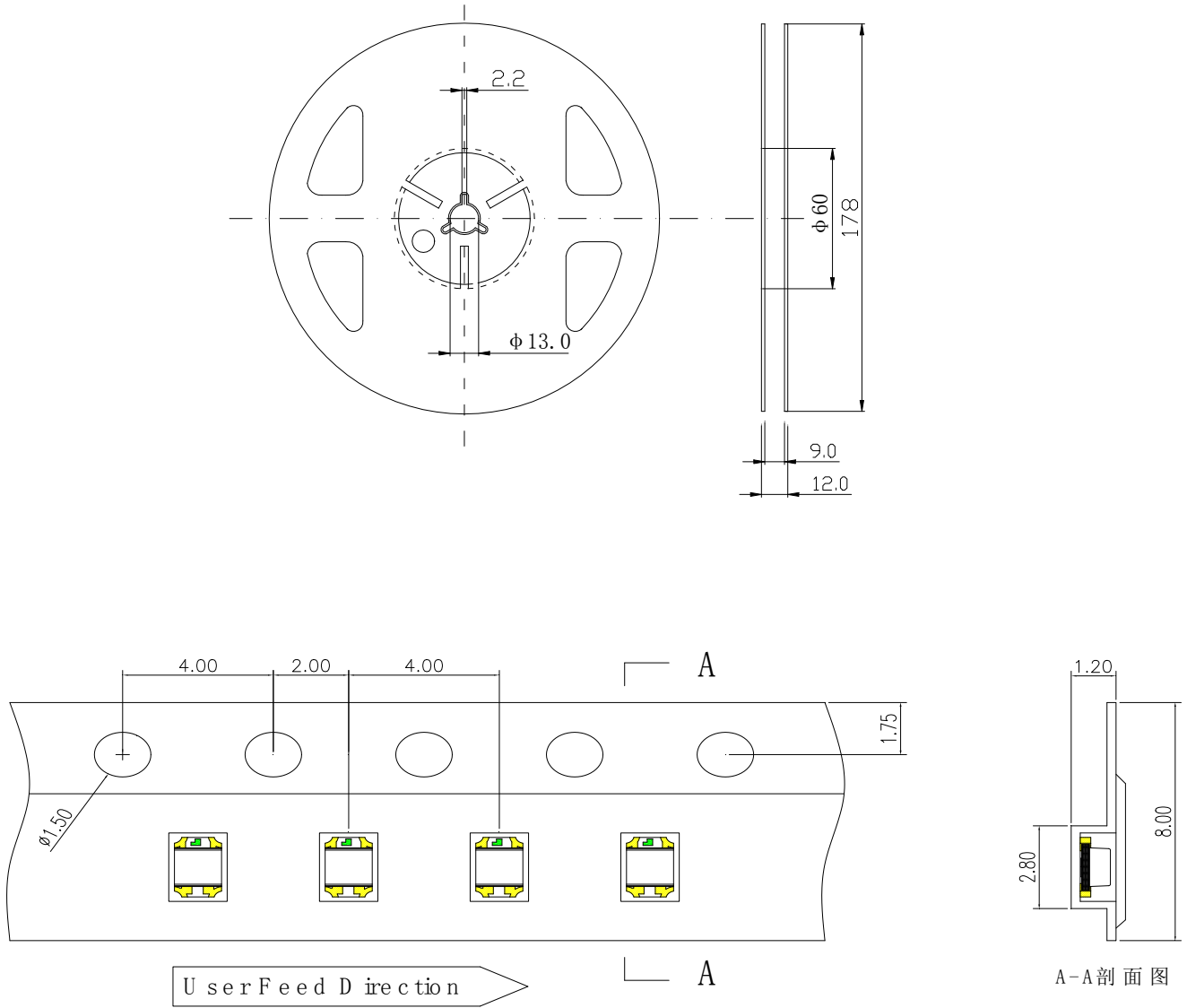

备注: 1. 尺寸单位为毫米(mm) ;

Remarks: 1 Dimensions are in millimeters (mm);

2.尺寸公差如无标注，为±0.15mm；

2. The dimensional tolerance is ± 0.15mm if not marked;

包装

Packaging (1)

◇ 防潮抗静电包装 Moisture Proof and Anti-Electrostatic Foil Bag

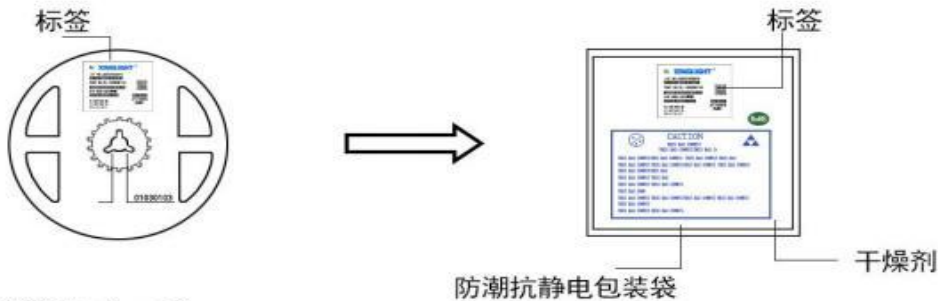

◇ 外包装箱 Cardboard Box

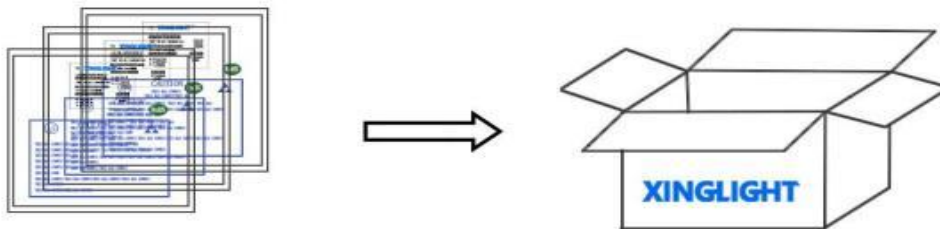

Capacity 5 or 10 reels per box (内箱容量: 50或100卷)

◇ 标签说明: Label Explanation

- LOT NO: 批次信息
- PART NO: 产品型号
- BIN CODE: 产品名称
- WL: 波长范围
- IV: 光强范围
- VF: 电压范围



3、注意事项 Cautions

1)、LED封装为硅胶，故LED胶体表面较软，用力按压胶体表面会影响LED可靠性，因此应有预防措施避免在封装的零件上的强大压力，当使用吸嘴时，胶体表面的压力应是恰当的。

The encapsulated material of the LEDs is silicone. Therefore the LEDs have a soft surface on the top of package. The pressure to the top surface will be influence to the reliability of the LEDs. Precautions should be taken to avoid the strong pressure on the encapsulated part. So when use the picking up nozzle, the pressure on the silicone resin should be proper.

2)、SMD吸嘴的外径不应超过LED的尺寸以避免漏气。吸嘴的内径应尽可能大。吸嘴头建议使用柔软的材料以避免LED硅胶表面划伤或损坏。

The outer diameter of the SMD pickup nozzle should not exceed the size of the LED prevent air leaks. The inner diameter of the nozzle should be as large as possible. p material is suggested for the nozzle tip to avoid scratching or damaging the LED sur during pickup.

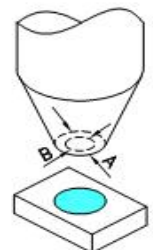

焊接指导 (1)

Guideline for Soldering (1)

1. 使用烙铁人手焊接

Hand Soldering

推荐使用功率低于 20W 的烙铁，焊接时烙铁的温度必须保持在 300°C 以下，且每个电极只能进行一次焊接，每次焊接的持续时间不得超过 3 秒。

人手焊接过程中的不慎操作易引起 LED 产品的损坏，应当小心谨慎。

A soldering iron of less than 20W is recommended to be used in Hand Soldering. Please keep the temperature of the soldering iron under 300°C while soldering. Each terminal of the LED is to go for less than 3 second and for one time only.

Be careful because the damage of the product is often started at the time of the hand soldering.

2. 回流焊接： 推荐使用以下无铅回流焊接温度图进行。

Reflow Soldering: Use the conditions shown in the under Figure of Pb-Free Reflow Soldering.

- 回流焊接最多只能进行一次。

Reflow soldering should not be done more than once .

- 在回流焊接升温过程中，请不要对 LED 施加任何压力。

Stress on the LEDs should be avoided during heating in soldering process.

- 在焊接完成后，待产品温度下降到室温之后，再进行其他处理。

After soldering, do not deal with the product before its temperature drop down to room temperature.

建议焊接温度曲线：

Recommended welding curve temperature

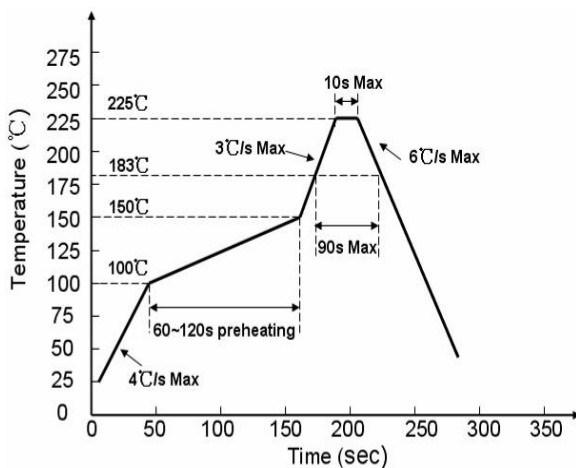

有铅制程
Lead process

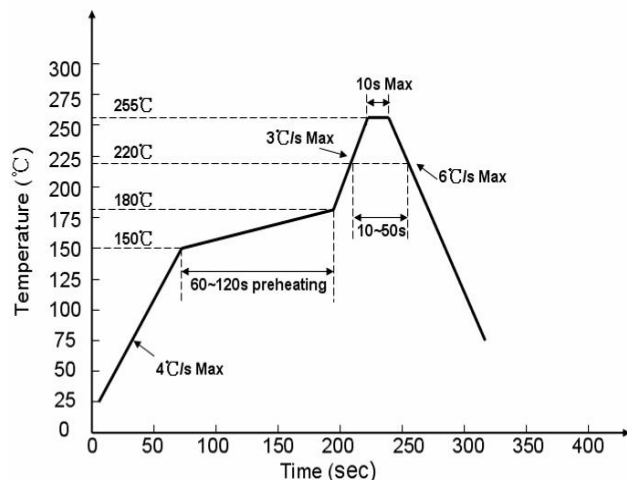

无铅制程
Lead-free Process

焊接指导（2）

Guideline for Soldering (2)

3. 清洗：

Cleaning

在焊接后推荐使用酒精进行清洗，在温度不高于 30°C 的条件下持续 3 分钟，不高于 50°C 的条件下持续 30 秒。使用其他类似溶剂清洗前，请先确认使用的溶剂不会对 LED 的封装和环氧树脂部分造成损伤。

超声波清洗也是有效的方法，一般最大功率不应超过 300W，否则可能对 LED 造成损伤。请根据具体的情况预先测试清洗条件是否会对 LED 造成损伤。

It is recommended that alcohol be used as a solvent for cleaning after soldering. Cleaning is to go under 30°C for 3 minutes or 50°C for 30 seconds. When using other solvents, it should be confirmed beforehand whether the solvents will dissolve the package and the resin or not.

Ultrasonic cleaning is also an effective way for cleaning. But the influence of Ultrasonic cleaning on LED depends on factors such as ultrasonic power. Generally, the ultrasonic power should not be higher than 300W. Before cleaning, a pretest should be done to confirm whether any damage to LEDs will occur.

- * **注意：** 此一般指导原则并不适用于所有 PCB 设计和焊接设备的配置。具体工艺受到诸多因素的影响，请根据特定的PCB设计和焊接设备来确定焊接方案。
- * **Note:** This general guideline may not apply to all PCB designs and configurations of all soldering equipment. The technics in practise is influenced by many factors, it should be specialized base on the PCB designs and configurations of the soldering equipment..

使用注意事项（1）

Precautions (1)

1. 贮存:

Storage

- 本产品使用密封防潮抗静电袋包装，并附有干燥剂，未开封的产品有一年的保存时间。

Moisture proof and anti-electrostatic package with moisture absorbent material is used, to keep moisture to a minimum.

- 开封前，产品须存放在温度不高于 30℃，湿度不高于 60%RH 的环境中。

Before opening the package, the product should be kept at 30℃ or less and humidity less than 60% RH, and be used within a year.

- 开封后，产品须存放在温度不高于 30℃，湿度不高于 10%RH 的环境中，且应该在 168 小时（7 天）内使用完。建议工作环境为温度不高于 30℃，湿度不高于 60%RH。

After opening the package, the product should be stored at 30℃ or less and humidity less than 10%RH, and be soldered within 168 hours (7 days). It is recommended that the product be operated at the workshop condition of 30℃ or less and humidity less than 60%RH.

- 对于尚未焊接的 LED，如果吸湿剂或包装失效，或者产品没有符合以上有效存储条件，烘焙可以起到一定的性能恢复效果。烘焙条件：(60±5)℃，持续 24 小时。

If the moisture absorbent material has fade away or the LEDs have exceeded the storage time, baking treatment should be performed based on the following condition: (60±5)℃ for 24 hours.

2. 静电:

Static Electricity

静电和电涌会导致产品特性发生改变，例如正向电压降低等，如果情况严重甚至会损毁产品。所以在使用时必须采取有效的防静电措施。

所有相关的设备和机器都应该正确接地，同时必须采取其他防止静电和电涌的措施。

使用防静电手环，防静电垫子，防静电工作服、工作鞋、手套，防静电容器，都是有效的防止静电和电涌的措施。

Static electricity or surge voltage damages the LEDs. Damaged LEDs will show some unusual characteristic such as the forward voltage becomes lower, or the LEDs do not light at the low current. even not light.

All devices, equipment and machinery must be properly grounded. At the same time, it is recommended that wrist bands or anti-electrostatic gloves, anti-electrostatic containers be used when dealing with the LEDs.

使用注意事项 (2)

Precautions (2)

3. 设计建议:

Design Consideration

设计电路时，通过 LED 的电流不能超过规定的最大值，同时，还需使用保护电阻，否则，微小的电压变化将会引起较大的电流变化，可能导致产品损毁。

建议使用以下 (A) 电路，该电路能够很好的调节通过每个 LED 的电流；不推荐使用 (B) 电路，该电路在持续的电压驱动下，LED 的正向电压 (V_F) 发生变化，电流会随之而发生变化，可能使某些 LED 承受高于规定的电流值。

In designing a circuit, the current through each LED must not exceed the absolute maximum rating specified for each LED. In the meanwhile, resistors for protection should be applied, otherwise slight voltage shift will cause big current change, burn out may happen.

It is recommended to use Circuit A which regulates the current flowing through each LED rather than Circuit B. When driving LEDs with a constant voltage in Circuit B, the current through the LEDs may vary due to the variation in Forward Voltage (V_F) of the LEDs. In the worst case, some LED may be subjected to stresses in excess of the Absolute Maximum Rating.

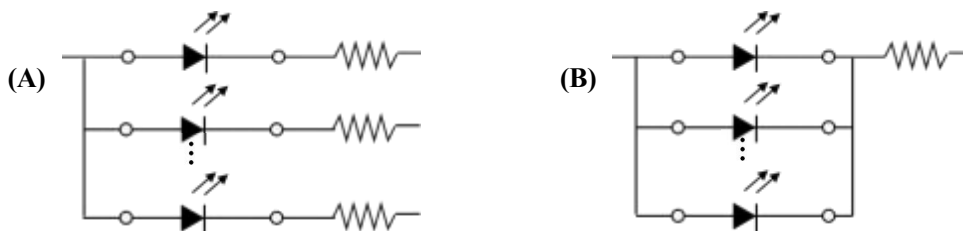

LED 的特性容易因为自身的发热和环境的温度的改变而发生改变。温度的升高会降低 LED 的发光效率、影响发光颜色等，所以在设计时应充分考虑散热的问题。

Thermal Design is paramount importance because heat generation may result in the Characteristics decline, such as brightness decreased, Color changed and so on. Please consider the heat generation of the LEDs when making the system design.

使用注意事项 (3)

Precautions (3)

4. 其他事项:

Others

直接用手拿取产品不但会污染封装树脂表面，也可能由于静电等因素导致产品性能的改变。过度的压力也可能直接影响封装内部的管芯和金线，因此请勿对产品施加过度压力，特别当产品处于高温状态下，例如在回流焊接过程中。

When handling the product, touching the encapsulant with bare hands will not only contaminate its surface, but also affect on its optical characteristics. Excessive force to the encapsulant might result in catastrophic failure of the LEDs due to die breakage or wire deformation. For this reason, please do not put excessive stress on LEDs, especially when the LEDs are heated such as during Reflow Soldering.

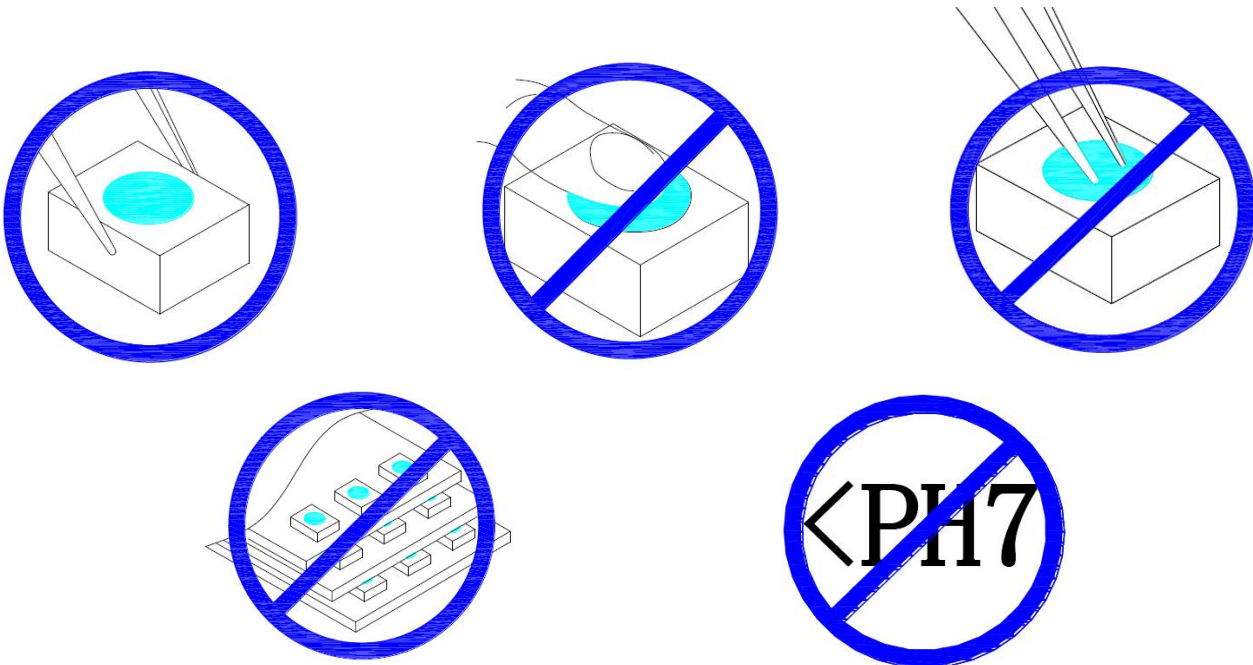

LED 的环氧树脂封装部分相当脆弱，请勿用坚硬、尖锐的物体刮、擦封装树脂部分。在用镊子夹取的时候也应当小心注意。

The epoxy resin of encapsulant is fragile, so please avoid scratch or friction over the epoxy resin surface. While handling the product with tweezers, do not hold by the epoxy resin, be careful.

不可用在PH<7的酸性场所。 Not suitable to operate in acidic environment.

5. 眼睛保护忠告:

Safety Advice For Human Eyes

LED 发光时，请勿直视发光光源，特别是对于一些光强较高的 LED，强光可能伤害你的眼睛。

Viewing direct to the light emitting center of the LEDs, especially those of great Luminous Intensity, will cause great hazard to human eyes. Please be careful.