

**XL-HD3535SURC-A2****技术数据表** Technical Data Sheet**3535 球头红 贴片式发光二极管****特点 (Characteristic) :**

- \* 外观尺寸 (L/W/H) :3.5\*3.5\*2.0mm  
OutlineDimensions (L / w / h): 3.5 x 3.5 x 2.0 mm
- \* 发光颜色及胶体: 红色/透明胶体  
Luminous color and colloid: Red /Transparent colloid
- \* 高光输出功率  
High light output power
- \* 寿命长, 低光衰  
Long life and low light attenuation
- \* 耐用, 防冲击, 易设计, 适合在多领域应用  
Durable, impact resistant, easy to design, suitable for multi field applications
- \* 节能, 高可靠性  
Energy saving and high reliability
- \* 环保工艺符合ROHS要求  
Environmental protection products Complied With RoHS Directive

**应用领域 (Product application) :**

- \* 手机相机闪光灯 (用于移动设备的相机闪光灯/频闪灯)  
Mobile camera flash (camera flash / strobe for mobile devices)
- \* 用于DV (数字视频) 应用的手电筒  
Flashlight for DV (digital video) applications
- \* 信号灯和符号灯  
Signal and symbol lights
- \* 外部和内部照明应用  
Exterior and interior lighting applications
- \* 装饰和娱乐照明  
Decorative and entertainment lighting

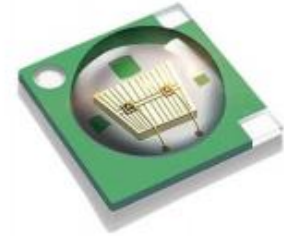

---

## 目录

---

### Catalogue

电性参数	
Electrical Characteristics.....	3
典型特性曲线	
Typical Characteristic Curves.....	4
外形尺寸	
Outline Dimensions.....	5
包装	
Packaging.....	6
焊接指导	
Guideline for Soldering.....	8
使用注意事项	
Precautions.....	10

## 电性参数

## Electrical Characteristics

◆极限参数 (温度=25℃): Absolute Maximum Ratings(Temperature=25℃):

项目 Item	符号 Symbol	最大额定值 Absolute Maximum Rating	单位 Unit
正向电流 Forward Current	IF	350	mA
正向峰值电流 Pulse Forward Current	IFP	350	mA
反向电压 Reverse Voltage	VR	5	V
功率消耗 Power Dissipation	PD	1	W
工作温度 Operating Temperature	Topr	-20℃ TO +65℃	℃
贮藏温度 Storage Temperature	Tstf	0℃ TO 40℃	℃
焊接温度 Soldering Temperature	Tsld	Reflow Soldering:260℃ for 3sec	

- 注: 1. 辐射通量测量公差: ±10%; Radiant flux measurement tolerance:±10%  
 2. 正向电压测量公差: ±3%; Forward voltage measurement tolerance:±3%  
 3. 峰值波长测量公差: ±3nm; Peak wavelength measurement tolerance:±3nm  
 4. 1/10占空比, 0.1ms脉冲宽度; 1/10 Duty Cycle,0.1ms Pulse Width  
 5. 基板的温度不超过55℃。The temperature of Aluminum PCB do not exceed 55℃

## 光电参数 (温度=25℃):

Electro-Optical Characteristics (Temperature=25℃):

参数名称 Parameter	符号 Symbol	测试条件 Condition	数值 Value			单位Unit
			最小Min	典型Typ	最大Max	
正向电压Forward Voltage	Vf	IF=350mA	1.8	-	2.6	V
光通量 Luminous flux	Φe	WD=620-630nm	20	-	60	LM
显色指数Color rendering index	RA	IF=350mA	-	-	-	-
反向电流 Reverse Current	IR	VR=5V	-	-	10	uA
全视角 Viewing angle	2θ1/2	IF=350mA	-	120	-	Deg
晶片结温Junction temperature	Tj	IF=350mA	-	-	125	℃
热阻 Thermal resistance	Rthj-s	IF=350mA	-	-	40	℃/W
抗静电能力ESD Sensitivity (HBM)	ESD	IF=350mA	2000V			

**亮度分档:****Brightness grading:**

代码 Code	最小值 Min	最大值 Max	单位 Unit	测试条件 Test conditions
I12	40	60	LM	IF=350mA

**电压分档:****Voltage grading:**

代码 Code	最小值 Min	最大值 Max	单位 Unit	测试条件 Test conditions
A05	2.2	2.4	V	IF=350mA

**波长分档:****Wavelength grading:**

代码 Code	最小值 Min	最大值 Max	单位 Unit	测试条件 Test conditions
HR02	620	625	nm	IF=350mA

## 典型特性曲线

### Typical Characteristics Curves

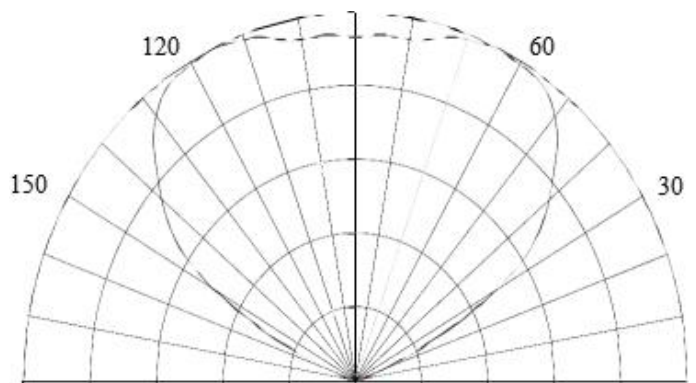
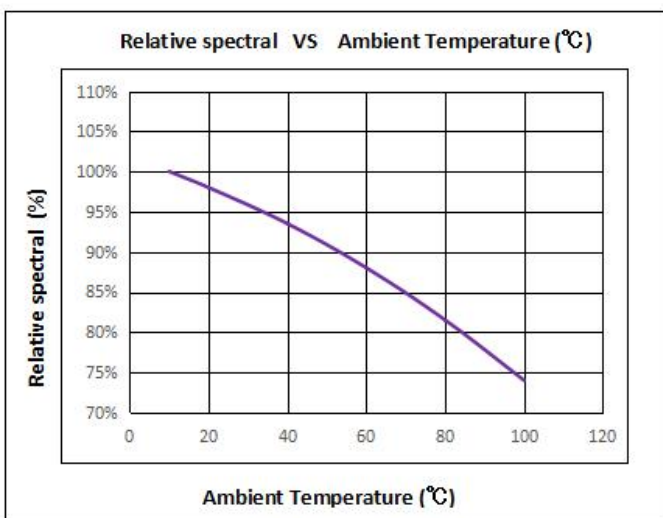
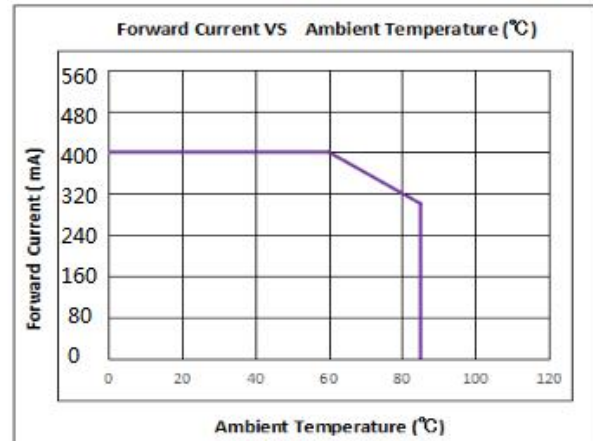
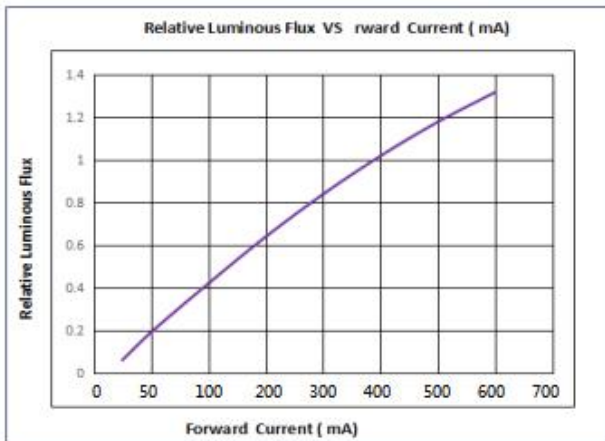
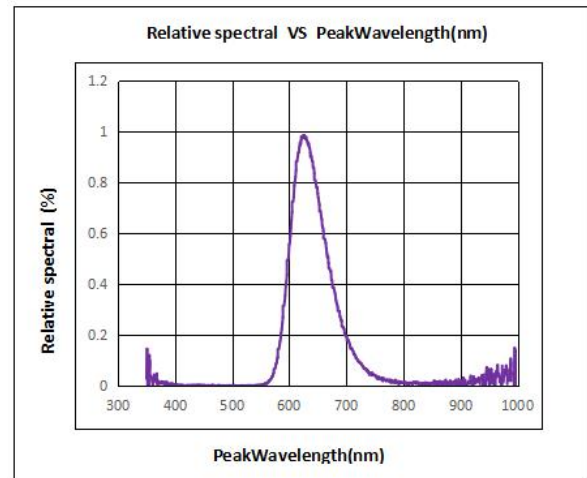
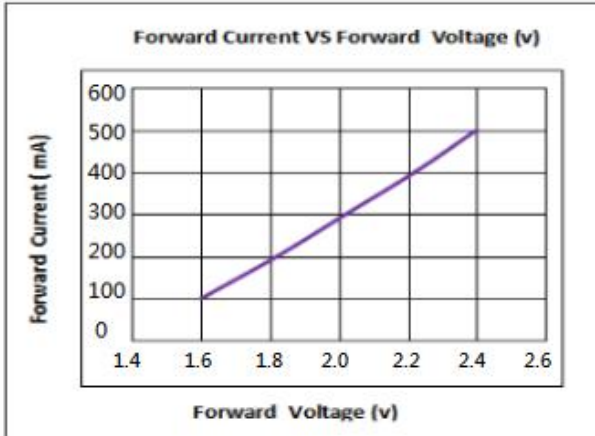

## 外形尺寸

### Outline Dimension

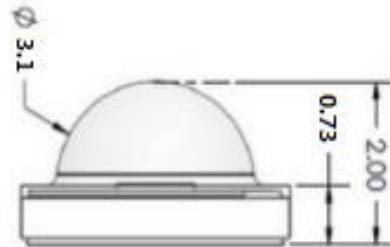
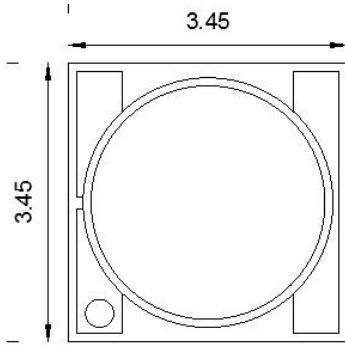

### 推荐焊盘图:

### Suggest Soldering Pad Dimensions:

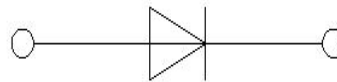
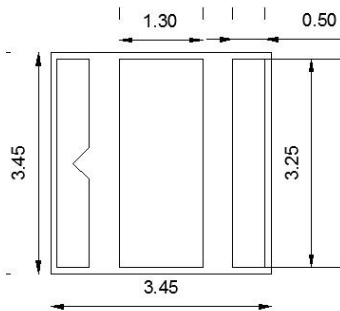

### 注 (Note) :

1. 单位 : 毫米 (mm) Unit: mm
2. 公差 : 如无特别标注则为 $\pm 0.1$  mm  
Tolerances:  $\pm 0.1$  mm if unmarked.
3. 在不影响电路配置时, 建议增加中间焊盘覆铜区域, 或中间焊盘和负极焊盘连接, 能提高产品散热性能。建议使用热电分离的铜基板作为散热基板。建议使用钢网厚度为0.6-1mm  
When the circuit configuration is not affected, it is recommended to increase the copper clad area of the intermediate pad or the connection between the intermediate pad and the negative pad, which can improve the product quality. Performance. It is recommended to use copper substrate with thermoelectric separation as heat dissipation substrate. It is recommended to use steel mesh with a thickness of 0.6-1mm.

## 包装 (1)

### Packaging (1)

编带包装 Fabric with packaging

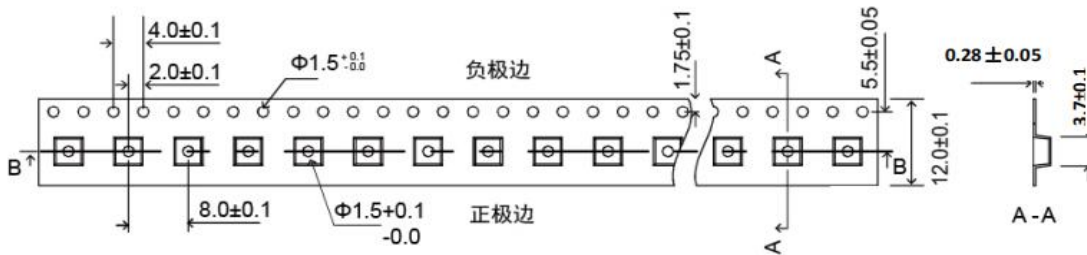

注 (Note) :

1. 尺寸单位为毫米(mm)。
1. Size unit is mm (mm).
2. 尺寸公差是 $\pm 0.1$ mm。
2. The dimensional tolerance is  $\pm 0.1$ mm.

卷轴尺寸 Scroll size

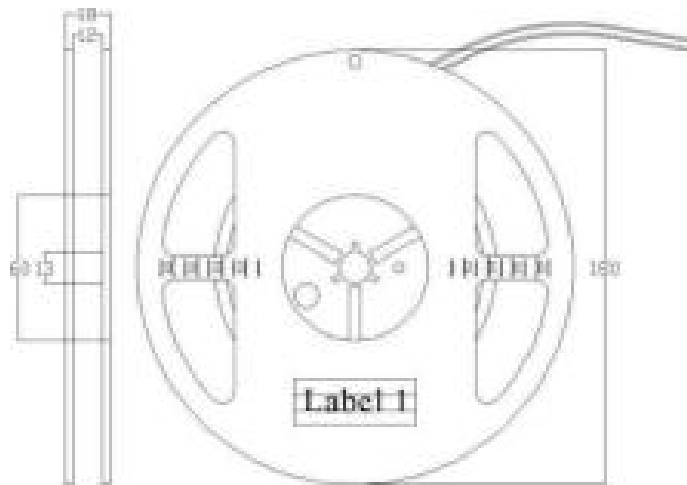

## 包装 (2)

### Packaging (2)

#### ◇ 防潮防静电包装 Moisture Proof and Anti-Electrostatic Foil Bag

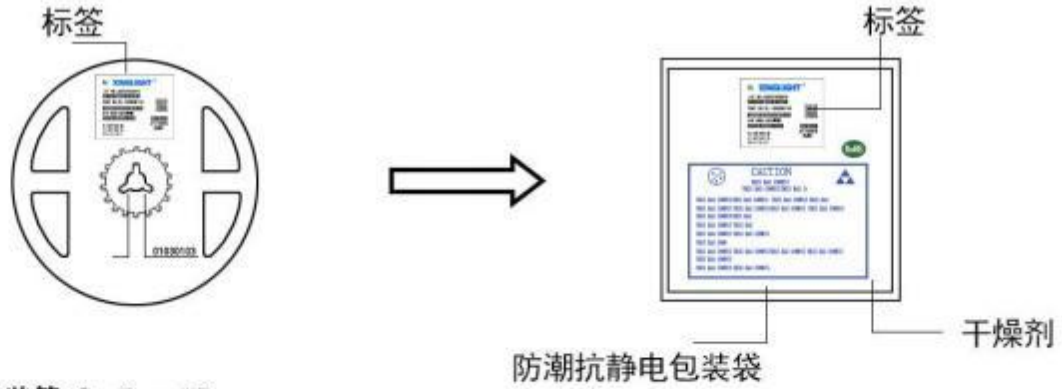

#### ◇ 外包装箱 Cardboard Box

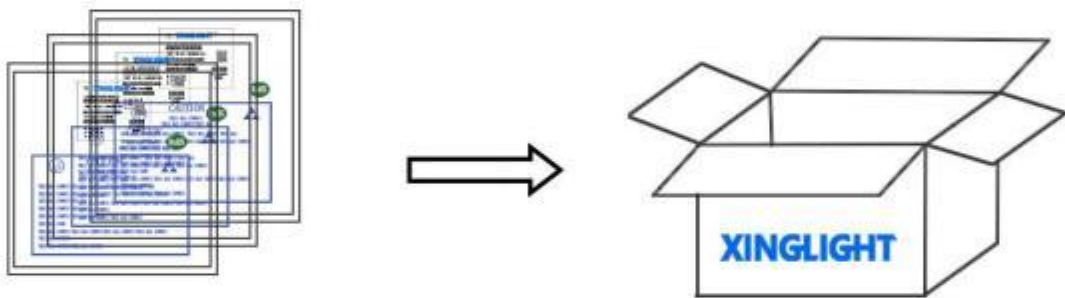

Capacity 5 or 10 reels per box (内箱容量: 50或100卷)

#### ◇ 标签说明: Label Explanation

- LOT NO: 批次信息
- PART NO: 产品型号
- BIN CODE: 产品名称
- WL: 波长范围
- IV: 光强范围
- VF: 电压范围





## 焊接指导 (1)

### Guideline for Soldering (1)

#### 1. 回流焊接曲线图 IR reflow soldering Profile

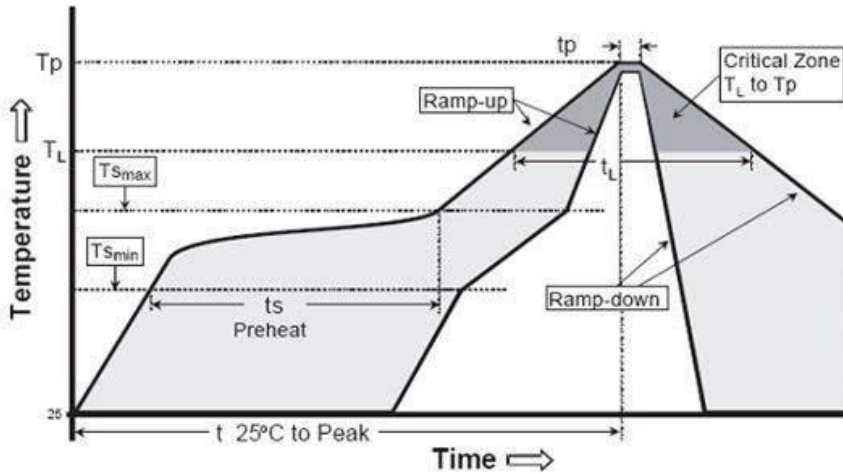

轮廓特征 Profile Feature	铅基焊料 Lead-Based solder	无铅焊料 Lead-Free Solder
平均斜坡率Average Ramp-Rate ( $T_{smax}$ to $T_p$ )	3°C/second max 3°C/秒最大值	3°C/second max 3°C/秒最大值
预热: 最低温度Preheat: Temperature Min ( $T_{smin}$ )	100°C	150°C
预热: 最高温度Preheat: Temperature Max ( $T_{smax}$ )	150°C	200°C
预热: 时间Preheat: Time( $t_{smin}$ to $t_{smax}$ )	60-120 seconds 60-120秒	60-180 seconds 60-180秒
维持时间: 温度Time Maintained Above: Temperature( $T_l$ )	183°C	217°C
保持上述时间: 时间Time Maintained Above: Time( $t_l$ )	60-150 seconds 60-150秒	60-150 seconds 60-150秒
峰值/分类温度Peak/Classification Temperature( $T_p$ )	215°C	260°C
实际峰值温度Time Within 5°C of Actual Peak Temperature( $t_p$ )	10-15 seconds	20-40 seconds
缓降速率Ramp-Down Rate	6°C/secondmax 6°C/秒最大值	6°C/second max 6°C/秒最大值
25°C至最高温度的时间 Time 25°C to Peak Temperature	6 minutes max 最多6分钟	8 minutes max 最多8分钟

备注 Note:

1. recommend to use a convection type reflow machine with 8 zones.  
建议使用八温区回流焊机, 参考曲线 145°-165°-185°-210°-220°-240°-260°-240°运输速度60-90cm/min。
2. recommend to use Lead-Free Paste with a melting point between 210°C-220°C.  
建议使用熔点为210°C-220°C的无铅锡膏。
3. Reflow soldering should not be done more than two times. The reflow soldering time should not be more than 360s. all temperature means the temperature measured on the surface of the package body.  
回流焊不能超过两次, 总的回流焊时间不要超过360s, 所有温度均指在封装本体表面上测得的温度。
4. When using hot plate, the temperature is no more than 260 °C, the time is not more than 5 seconds.  
当使用热板作业时, 温度不超过260°C, 时间不超过5秒。

---

## 焊接指导 (2)

---

### Guideline for Soldering (2)

#### 2.清洗 Cleaning

在焊接后推荐使用酒精进行清洗，在温度不高于 30°C的条件下持续 3 分钟，不高于 50°C的条件下持续 30 秒。使用其他类似溶剂清洗前，请先确认使用的溶剂不会对 LED 的封装和环氧树脂部分造成损伤。

超声波清洗也是有效的方法，一般最大功率不应超过 300W，否则可能对 LED 造成损伤。请根据具体的情况预先测试清洗条件是否会对 LED 造成损伤。

It is recommended that alcohol be used as a solvent for cleaning after soldering. Cleaning is to go under 30°C for 3 minutes or 50°C for 30 seconds. When using other solvents, it should be confirmed beforehand whether the solvents will dissolve the package and the resin or not.

Ultrasonic cleaning is also an effective way for cleaning. But the influence of Ultrasonic cleaning on LED depends on factors such as ultrasonic power. Generally, the ultrasonic power should not be higher than 300W. Before cleaning, a pretest should be done to confirm whether any damage to LEDs will occur.

- \* **注意：** 此一般指导原则并不适用于所有 PCB 设计和焊接设备的配置。具体工艺受到诸多因素的影响，请根据特定的PCB设计和焊接设备来确定焊接方案。
- \* **Note:** This general guideline may not apply to all PCB designs and configurations of all soldering equipment. The technics in practise is influenced by many factors, it should be specialized base on the PCB designs and configurations of the soldering equipment..

## 使用注意事项（1）

### Precautions (1)

#### 1. SMT吸嘴选取: How to choose the collet

吸嘴设置不当时产生的异常: (Abnormal situation caused by improper setting of collet)

选取合适的吸嘴是提高产品品质的关键所在, 因 LED 与其它电子元件不同, 它所承担的不只是电性的输出还有光学部份的输出, 因此特性就决定了 LED 的命运在 SMT 过程中变的比较脆弱。若机器吸嘴下压高度设置的不当, 即当吸嘴在吸起和放下材料的时候都有可能造成对 LED 的不亮或闪烁及品质问题。

To choose the right collet is the key issue in improving the product's quality. LED is different from other electronic components, which is not only about electrical output but also for optical output. This If the collet's lowering down height is not well set, it will bring damage to the gold wire at the time of collet's picking up and loaing which will cause the LED fail to light up, light up now and then or other quality problems.

#### 2. 吸嘴的选取: How to choose the collet

客户在 SMT 时直径尽量选择比 LED (胶体) 发光面大的吸嘴防止吸嘴下压高度设置的不当造成对 LED 内部金线的损坏。根据不同产品吸嘴选取如下图:

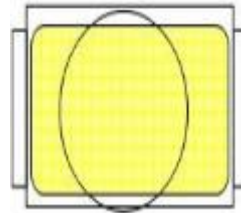

During SMT, please choose the collet that has larger outer diameter than the lighting area of lens, in case that improper position of collet will damage the gold wire inside the LED. Different collets fit for different products, please refer to the following pictures cross out.

#### 3. 储存: Store

为避免受潮的影响, 我司建议产品在未开包装前储存条件为 5-30°C, 相对湿度小于 60%; 已开包装的 LED 光源请在 24H 内使用安装完毕, 如未用完之产品, 请进行除湿并抽真空后密封保存。开封超过一周或湿度卡发生变化时, 请务必进行除湿, 除湿条件: 60°C ± 5°C, 12H; 产品密封保存有效使用期为一年。

To avoid moisture, we recommend storage conditions for the unopened LED +5 ~ +30 °C, relative humidity <60%. LED should be used within 168 Hrs. of opening the package. Please make sure to dehumidify and vacuum pack the remaining/ unused LED. Dehumidifying condition: +120 °C ± 5 °C, 04 Hrs. Effective age for the sealed led is one year.

## 使用注意事项 (2)

### Precautions (2)

#### 4. 组装注意事项: The assembly notes

焊接条件: 此产品必须使用回流焊接的作业方式,回流曲线最高温度不可超过 260° C.作业或存放过程中不可有 1000g 以上的外力或尖锐物体作用于灯珠表面(如压力,摩擦等外力以及钳子镊子等工具),以免造成元件损伤;如果超出此使用条件,将不能保证产品的稳定性,如需使用超出的操作条件,请务必进行风险评估。

Soldering Conditions: This product must be used reflow soldering practices, the maximum temperature of reflow should not exceed 220°C. Please make sure when soldering, there is no external force on the soldering surface (such as pressure, friction or sharp metal nails, etc.), to avoid gold wire deformation or damage and other abnormalities. If beyond recommended conditions, we cannot guarantee the LED stability, please do the risk assessment first.

#### 5. 防静电措施 Anti-Static Measures

请采取足够的措施来防止静电产生,比如带静电环或防静电手指套等;每个制造工程关于产品(工厂、设备、机器、载波机和运输单位)应当连接地面,避免产品电气带电。

Please take adequate measures to prevent electrostatic generation, such as wearing electrostatic ring Or anti-static fingerstall etc; any relative products like plant equipment, machinery, carrier and transportation units shall be connected to discharging unit/ ground. After assembly, please make sure to discharge Static Electricity with proper ESD equipment.

#### 6. 温度控制 Temperature Control

为确保在组装时降低接触热阻,请注意在组装过程中,散热片采用良好品质的导热膏涂布均匀且分布面积合理,不可出现太少或高低不平等现象。散热介质需保证电介质耐压测试至少通过500V。

During assembly, please ensure that a good quality thermal paste is applied and distributed evenly over the surface. While using thermal pad (Heat Sink), make sure LED is firmly tightened and there is no gap between surfaces. The need to ensure the cooling medium dielectric withstand test at least through 500V.

#### 7. 驱动控制 Drive control

本产品需使用恒流源进行驱动,且输出电流符合规格书上的功率使用范围,如需使用恒压源或其他使用条件,请进行使用效果风险评估。

Drive this product at constant current. Output current range specifications should be according to the operational and other conditions, as mentioned in data sheet. Before using a constant voltage source or altered specifications, other than recommended, please consider risk factors.

## 使用注意事项 (3)

### Precautions (3)

#### 8. 其他事项: Others

直接用手拿取产品不但会污染封装树脂表面, 也可能由于静电等因素导致产品性能的改变。过度的压力也可能直接影响封装内部的管芯和金线, 因此请勿对产品施加过度压力, 特别当产品处于高温状态下, 例如在回流焊接过程中。

When handling the product, touching the encapsulant with bare hands will not only contaminate its surface, but also affect on its optical characteristics. Excessive force to the encapsulant might result in catastrophic failure of the LEDs due to die breakage or wire deformation. For this reason, please do not put excessive stress on LEDs, especially when the LEDs are heated such as during Reflow Soldering.

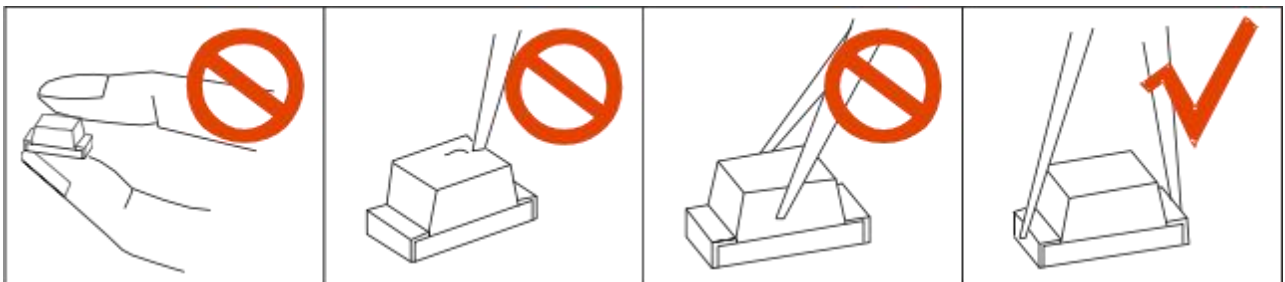

LED 的环氧树脂封装部分相当脆弱, 请勿用坚硬、尖锐的物体刮、擦封装树脂部分。在用镊子夹取的时候也应当小心注意。

The epoxy resin of encapsulant is fragile, so please avoid scratch or friction over the epoxy resin surface. While handling the product with tweezers, do not hold by the epoxy resin, be careful.

本产品不可在以下条件下使用, 如果产品在以下条件下使用, 评估其使用效果和风险是有必要的: 直接或间接的打湿或受潮, 比如淋雨等; 被海水损害或侵蚀; 被暴露于腐蚀性气体(如 Cl<sub>2</sub>, H<sub>2</sub>S、NH<sub>3</sub>、SO<sub>x</sub>、NO<sub>x</sub>等); 被暴露于粉尘、液体或油。

Product is not suitable to use in following conditions; Direct or indirect wet / damp conditions, such as rain, etc;  
in contact with sea water and erosive materials; Exposed to corrosive gases (e.g., Cl<sub>2</sub>, H<sub>2</sub>S, NH<sub>3</sub>, SO<sub>x</sub>, NO<sub>x</sub>, etc.);  
Exposed to dust, liquids or oils;

#### 9. 眼睛保护忠告: Safety Advice For Human Eyes

LED 发光时, 请勿直视发光光源, 特别是对于一些光强较高的 LED, 强光可能伤害你的眼睛。

Viewing direct to the light emitting center of the LEDs, especially those of great Luminous Intensity, will cause great hazard to human eyes. Please be careful.