

# DC Power Relays

## G9EN-1

### DC Power Relays that Enable DC Load Interruption at High Voltage and Current



- Enable downsizing, weight saving, and non-polarization in the main contact circuit (contact terminal) by using proprietary design of the contact block.
  - Contributes to improvements in the ease of wiring and mounting, and error-proofing against faulty wiring.
  - Class' smallest: H50 mm × W28 mm × L40 mm  
Class' lightest: approx. 140 g.  
Accomplished half-size reduction in volume and weight when compared to Omron's same class product (400 VDC, 60 A). \*
- \*Omron's internal investigation of August 2012

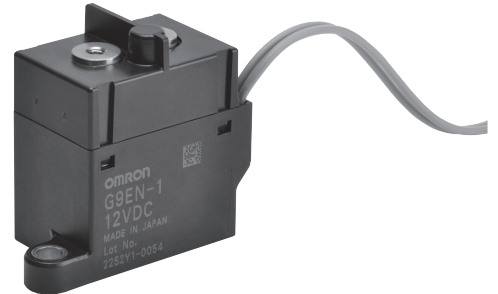

#### RoHS Compliant



Refer to the *Precautions* on page 4.

### Model Number Structure

G9EN-□-□-□-□-□  
1 2 3 4 5

1. Number of Poles  
1: 1 pole

3. Coil Terminals  
Blank: Lead wire output

2. Contact Form  
Blank: SPST-NO

4. Approved standard  
Blank: Standard  
UVD: UL/CSA/VDE approved standard type

5. Special Functions

### Ordering Information

Models	Terminals		Contact form	Rated coil voltage	Model
	Coil terminals	Contact terminals			
Switching/current conduction models	Lead wire	Screw terminals	SPST-NO	12 VDC 24 VDC	G9EN-1 (-UVD)

Note: Two M4 screws are provided for the contact terminal connection.

### Ratings

#### ● Coil

Rated voltage	Rated current	Coil resistance	Must-operate voltage	Must-release voltage	Maximum voltage(See note 3)	Power consumption
12 VDC	417 mA	28.8 Ω	60% max. of rated voltage	5% min. of rated voltage	130% of rated voltage (at 23°C within 10 minutes)	Approx. 5 W
24 VDC	208 mA	115.2 Ω				

Note: 1. The figures for the rated current and coil resistance are for a coil temperature of 23°C and have a tolerance of ±10%.

Note: 2. The figures for the operating characteristics are for a coil temperature of 23°C.

Note: 3. The figure for the maximum voltage is the maximum voltage that can be applied to the relay coil.

#### ● Contacts

Item	Resistive load
Rated load	60 A at 400 VDC
Rated carry current	60 A
Maximum switching voltage	400 V
Maximum switching current	60 A

## Characteristics

Item		G9EN-1	
Contact voltage drop		0.1 V max. (for a carry current of 60 A)	
Operate time		40 ms max.	
Release time		20 ms max.	
Insulation resistance *1	Between coil and contacts	1,000 MΩ min.	
	Between contacts of the same polarity	1,000 MΩ min.	
Dielectric strength	Between coil and contacts	2,500 VAC 1 min	
	Between contacts of the same polarity	2,500 VAC 1 min	
Impulse withstand voltage *2		4,500 V	
Vibration resistance *3	Destruction	5 to 200 to 5 Hz, Acceleration: 44.1 m/s <sup>2</sup>	
	Malfunction	5 to 200 to 5 Hz, Acceleration: 44.1 m/s <sup>2</sup>	
Shock resistance	Destruction	490 m/s <sup>2</sup>	
	Malfunction	Energized	490 m/s <sup>2</sup>
		Deenergized	98 m/s <sup>2</sup>
Mechanical endurance *4		200,000 min.	
Electrical endurance *5 *6		400 VDC, 60 A, 3,000 ops. min.	
Short-time carry current		180 A (1 min)	
Maximum interruption current *6		500 A at 400 VDC (3 times)	
Overload interruption *6		250 A at 400 VDC (200 times min.)	
Ambient operating temperature		-40 to 85°C (with no icing or condensation)	
Ambient operating humidity		5% to 85%	
Weight		Approx. 140 g	

Note: The above values are initial values at an ambient temperature of 23°C unless otherwise specified.

\*1. The insulation resistance was measured with a 500-VDC megohmmeter.

\*2. The impulse withstand voltage was measured with a JEC-212 (1981) standard impulse voltage waveform (1.2 × 50 μs).

\*3. The Upper limit of double amplitude: 10 mm P-P

\*4. The mechanical endurance was measured at a switching frequency of 3,600 operations/hr.

\*5. The electrical endurance was measured at a switching frequency of 60 operations/hr.

\*6. The switching performance and interruption performance were measured with a Zener diode and normal diode connected to absorb coil surge. These performances will be lower if only a normal diode is used.

## Engineering Data

### ● Maximum Switching Capacity\*

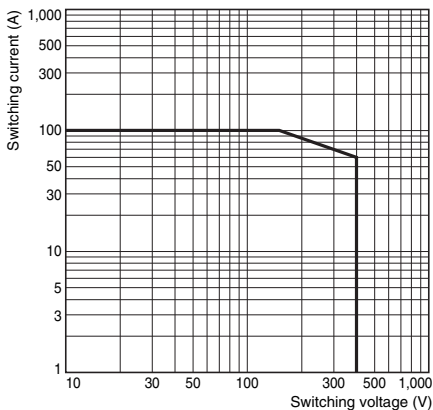

### ● Electrical Endurance (Switching Performance)\*

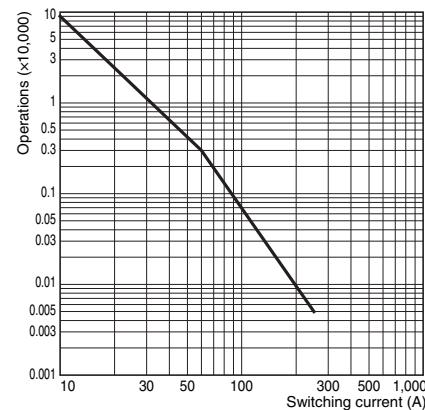

### ● Electrical Endurance (Interruption Performance)\*

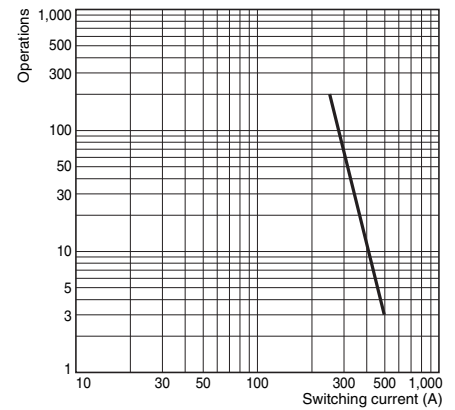

### ● Carry Current vs. Energizing Time

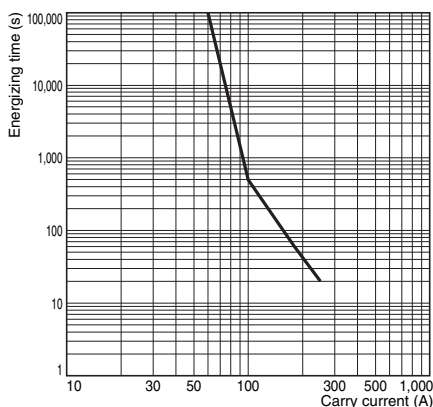

### ● Must-operate Voltage and Must-release Voltage Distributions (Number of Relays x Percentage of Rated Voltage)

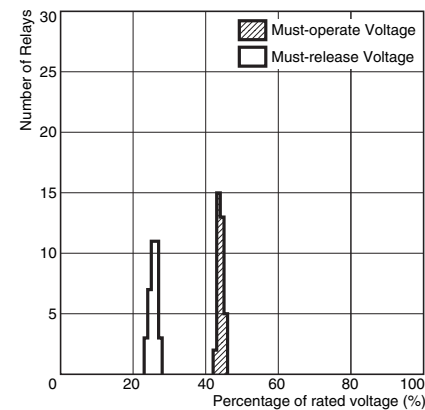

### ● Time Characteristic Distributions (Number of Contacts x Time (ms))

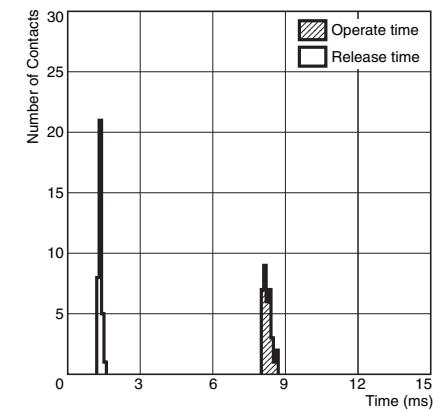

\* The switching performance and interruption performance were measured with a Zener diode and normal diode connected to absorb coil surge. These performances will be lower if only a normal diode is used.

## Vibration Malfunction

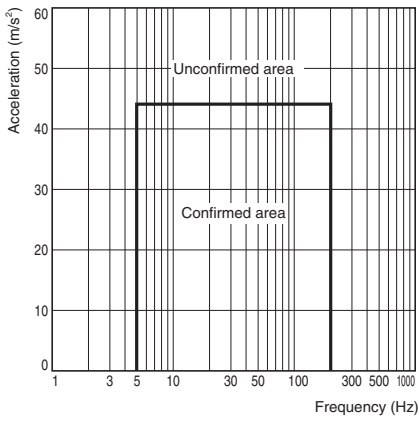

## Vibration Resistance

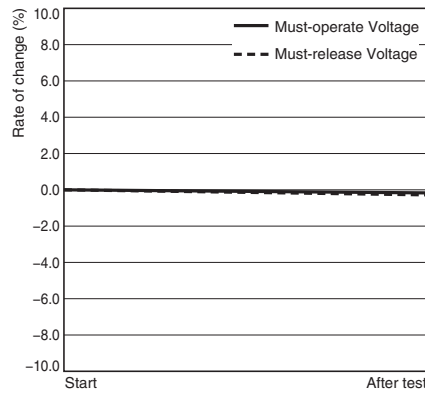

Characteristics were measured after applying vibration at a frequency of 5 to 200 to 5 Hz, acceleration of 44.1 m/s<sup>2</sup> to the test piece (not energized) for 2 hours each in 3 directions.  
The percentage rate of change is the average value for all of the samples.  
Note: The Upper limit of double amplitude: 10 mm P-P

## Shock Malfunction

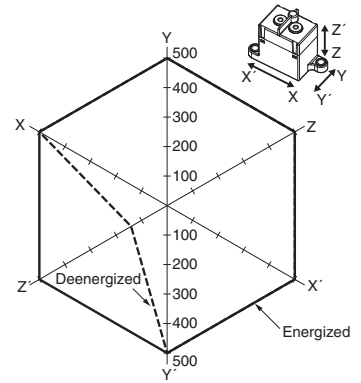

The value at which malfunction occurred was measured after applying shock to the test piece 3 times each in 6 directions along 3 axes.

## Shock Resistance

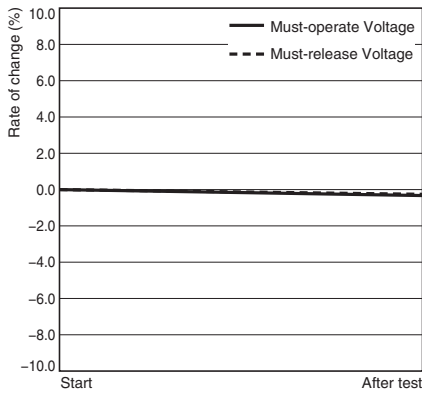

Characteristics were measured after applying a shock of 490 m/s<sup>2</sup> to the test piece 3 times each in 6 directions along 3 axes.  
The percentage rate of change is the average value for all of the samples.

## Dimensions (Unit: mm)

### G9EN-1

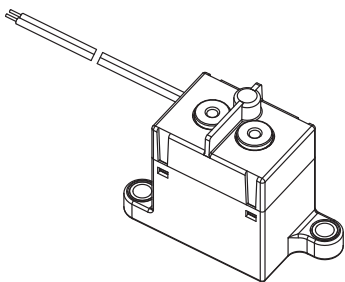

Dimension (mm)	Tolerance (mm)
10 or lower	±0.3
10 to 50	±0.5
50 or higher	±1

Two, M4 (Thread depth of screw terminal: 6mm minimum.)

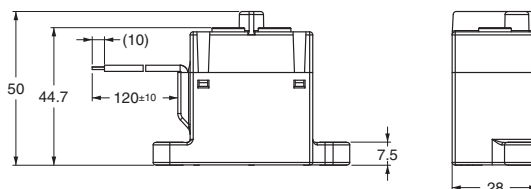
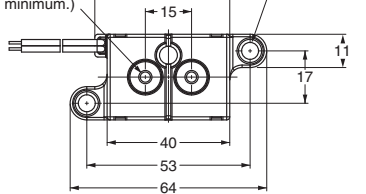

### Terminal Arrangement/ Internal Connections (TOP VIEW)

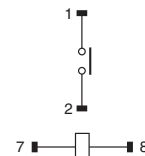

### Mounting Hole Dimensions (TOP VIEW)

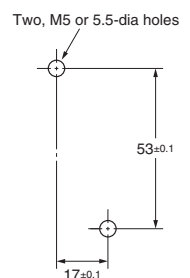

## Approved standards

UL Recognized: File No.E41515

CSA Certified: File No.LR31928

VDE Certified: File No.40037488

Model	Coil ratings	Contact ratings	Pollution level
G9EN-1-UVD	12 V, 24 V	60 A 500 VDC (Resistive) 60 A 277 VAC (Resistive)	2

Model	Coil ratings	Contact ratings	Pollution level
G9EN-1-UVD	12 V, 24 V	60 A 500 VDC (Resistive)	2

## Precautions

### ⚠ WARNING

Take measures to prevent contact with charged parts when using the Relay for high voltages.



### Precautions for Correct Use

Refer to the relevant catalog for common precautions.

- Be sure to tighten all screws to the appropriate torque given below. Loose screws may result in burning due to abnormal heat generation during energization.
  - M5 screws: 1.57 to 2.35 N·m
  - M4 screws: 0.98 to 1.37 N·m
- Do not drop or disassemble this Relay. Not only may the Relay fail to meet the performance specifications, it may also result in damage, electric shock, or burning.
- Do not use these Relays in strong magnetic fields of 800 A/m or higher (e.g., near transformers or magnets). The arc discharge that occurs during switching may be bent by the magnetic field, resulting in flashover or insulation faults.
- This Relay is a device for switching high DC voltages. If it is used for voltages exceeding the specified range, it may not be possible to interrupt the load and burning may result. In order to prevent fire spreading, use a configuration in which the current load can be interrupted in the event of emergencies.
 

In order to ensure safety of the system, replace the Relay on a regular basis.
- If the Relay is used for no-load switching, the contact resistance may increase and so confirm correct operation under the actual operating conditions.
- These Relays contain pressurized gas. Even in applications with low switching frequencies, the ambient temperature and heat caused by arc discharge in the contacts may allow permeation of the sealed gas, resulting in arc interruption failure. In order to ensure safety of the system, replace Relays on a regular basis.
- With this Relay, if the rated voltage (or current) is continuously applied to the coil and contacts, and then turned OFF and immediately ON again, the coil temperature, and consequently the coil resistance, will be higher than usual. This means that the must-operate voltage will also be higher than usual, exceeding the rated value ("hot start"). In this case, take the appropriate countermeasures, such as reducing the load current or restricting the energizing time or ambient operating temperature.
- The ripple percentage for DC relays can cause fluctuations in the must-operate voltage or humming. For this reason, reduce the ripple percentage in full-wave rectified power supply circuits by adding a smoothing capacitor. Ensure that the ripple percentage is less than 5%.

- Ensure that a voltage exceeding the specified maximum voltage is not continuously applied to the coil. Abnormal heating in the coil may shorten the lifetime of the insulation coating.
- Do not use the Relay at a switching voltage or current greater than the specified maximum values. Doing so may result in arc discharge interruption failure or burning due to abnormal heating in the contacts.
- The contact ratings are for resistive loads. The electrical endurance with inductive loads is inferior to that of resistive loads. Confirm correct operation under the actual operating conditions.
- Do not use the Relay in locations where water, solvents, chemicals, or oil may come in contact with the case or terminals. Doing so may result in deterioration of the case resin or abnormal heating due to corrosion or contamination of the terminals. Also, if electrolyte adheres to the output terminals, electrolysis may occur between the output terminals, resulting in corrosion of the terminals or wiring disconnections.
- Be sure to turn OFF the power and confirm that there is no residual voltage before replacing the Relay or performing wiring.
- The distance between crimp terminals or other conductive parts will be reduced and insulation properties will be lowered if wires are laid in the same direction from the contact terminals. Use insulating coverings, do not wire in the same direction, and take other measures as required to maintain insulation properties.
- Use either a varistor, or a diode plus Zener diode as a protective circuit against reverse surge in the relay coil. Using a diode alone will reduce the switching characteristics.
- Be sure to use the screws provided with the product for wiring coil terminals and contact terminals. The specified tightening torque cannot be achieved with different screws and may result in abnormal heat generation when energized.

### Recommended Wire Size

Model	Size
G9EN-1	14 to 22 mm <sup>2</sup>

Note: Use flexible leads.

• Application examples provided in this document are for reference only. In actual applications, confirm equipment functions and safety before using the product.  
 • Consult your OMRON representative before using the product under conditions which are not described in the manual or applying the product to nuclear control systems, railroad systems, aviation systems, vehicles, combustion systems, medical equipment, amusement machines, safety equipment, and other systems or equipment that may have a serious influence on lives and property if used improperly. Make sure that the ratings and performance characteristics of the product provide a margin of safety for the system or equipment, and be sure to provide the system or equipment with double safety mechanisms.

**Note: Do not use this document to operate the Unit.**