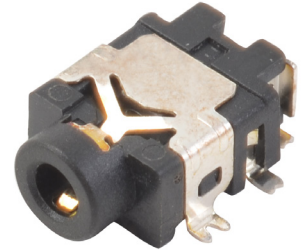
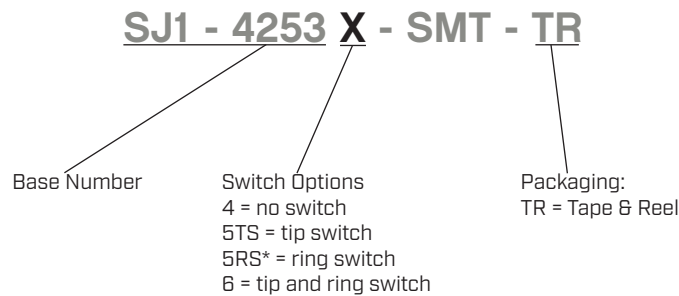

SERIES: SJ1-4253X-SMT | **DESCRIPTION:** AUDIO JACK

FEATURES

- low profile design
- switch options include:
 - no switch
 - tip switch
 - ring switch
 - tip and ring switch

PART NUMBER KEY

Notes: *Discontinued model SJ1-42535RS-SMT-TR

SPECIFICATIONS

parameter	conditions/description	min	typ	max	units
rated input voltage			12		Vdc
rated input current				1	A
contact resistance ¹	between terminal and mating plug between terminal in a closed circuit			50 30	mΩ mΩ
insulation resistance	at 500 Vdc	100			MΩ
voltage withstand	for 1 minute			500	Vac
insertion/withdrawal force		0.3		3	kg
operating temperature		-25		85	°C
life	at a rate of 24 cycles/minute		5,000		cycles
flammability rating	UL94V-0				
RoHS	yes				

Note: 1. When measured at a current of less than 100 mA/1 kHz
 2. All specifications measured at 10-35°C, humidity at 45-85%, under standard atmospheric pressure, unless otherwise noted.

MECHANICAL DRAWING

units: mm[inches]
 tolerance:
 X.X ±0.2 mm
 X.XX ±0.10 mm
 X.XXX ±0.050 mm
 PCB: ±0.05 mm

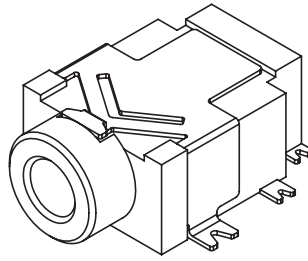

	MATERIAL	PLATING
terminal 1	copper alloy	silver
terminal 2	copper alloy	silver
terminal 3	copper alloy	silver
terminal 4	copper alloy	silver
terminal 5	brass	silver
terminal 6	brass	silver
plastic	PABT or equivalent	

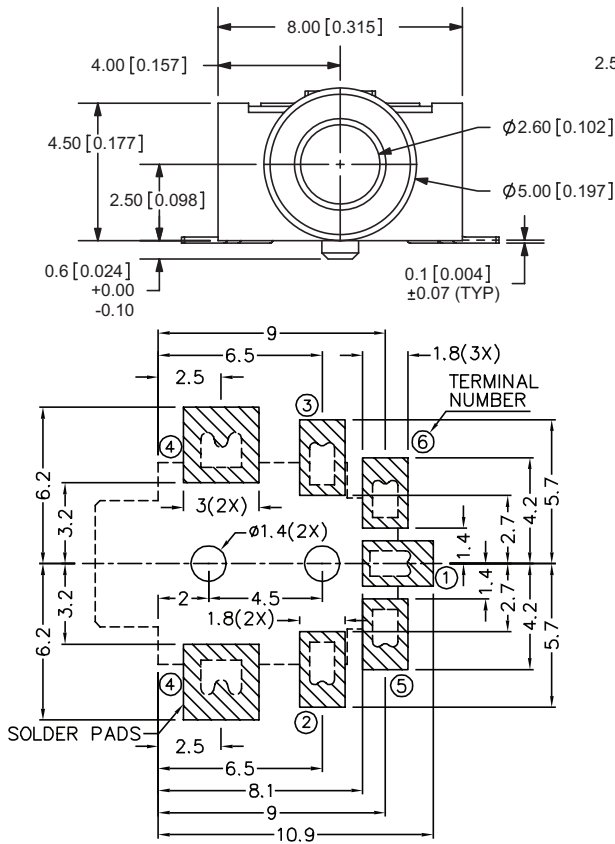

Recommended PCB Layout
Top View

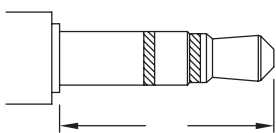
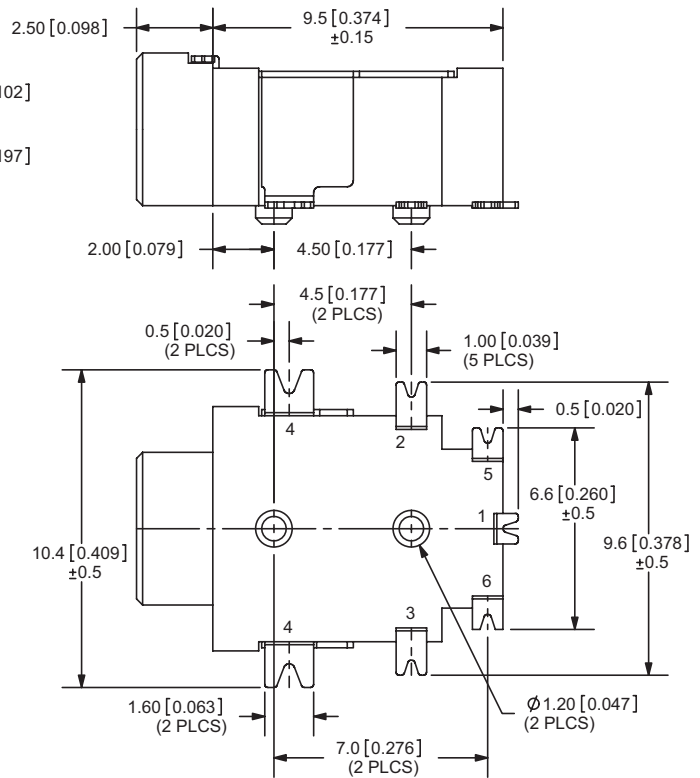

11
Ø 2.5 MATING PLUG

Model No.	SJ1-42534-SMT	SJ1-42535TS-SMT	SJ1-42535RS-SMT	SJ1-42536-SMT
Schematic				
PIN				
1	sleeve	sleeve	sleeve	sleeve
2	tip	tip	tip	tip
3	ring 1	ring 1	ring 1	ring 1
4	ring 2	ring 2	ring 2	ring 2
5	NP	tip switch	NP	tip switch
6	NP	NP	ring switch	ring switch

SOLDERABILITY

parameter	conditions/description	min	typ	max	units
reel storage	at relative humidity <80%			40	°C
reflow soldering ¹	see reflow profile	255	260	265	°C
drying conditions ²	parts in reel: bake at 40°C ±5°C for 72 hours parts removed from reel: bake at 40°C ±5°C for 10 hours				

Note: 1. Must reflow solder within 72 hours from opening vacuum packaging at a temperature <30°C & relative humidity <60%.
2. When exceeding floor life by >72 hours.

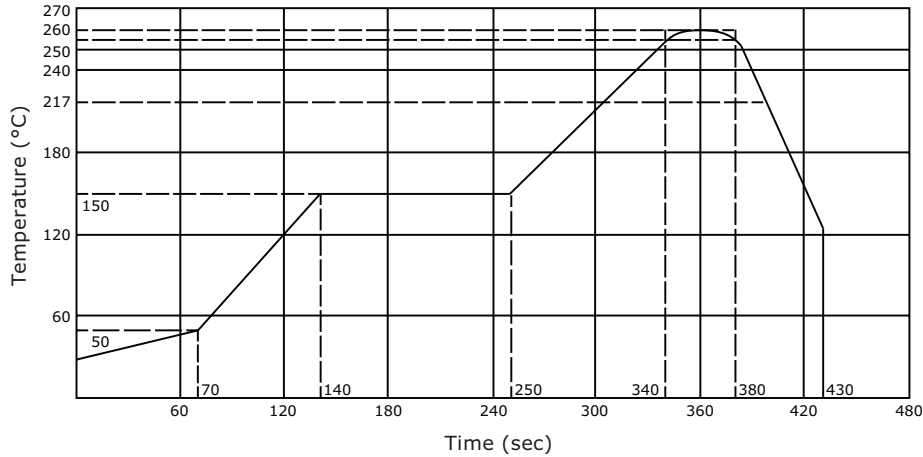

PACKAGING

units: mm

Reel Size: Ø381 mm
Reel QTY: 1,000 pcs per reel

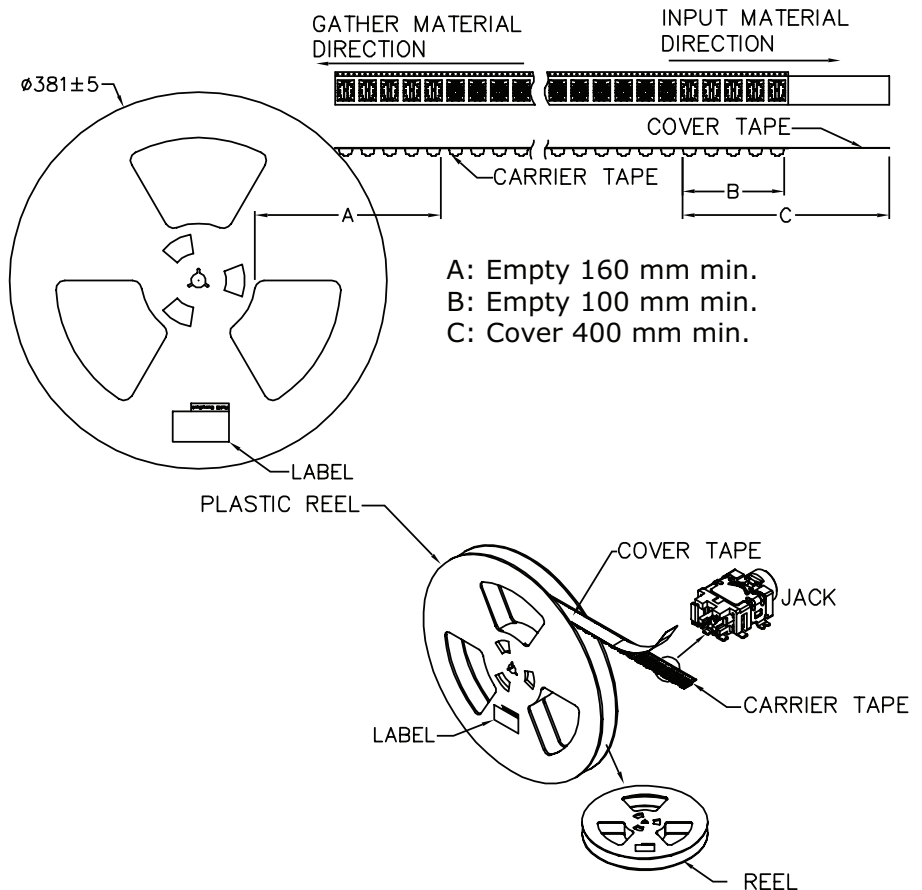
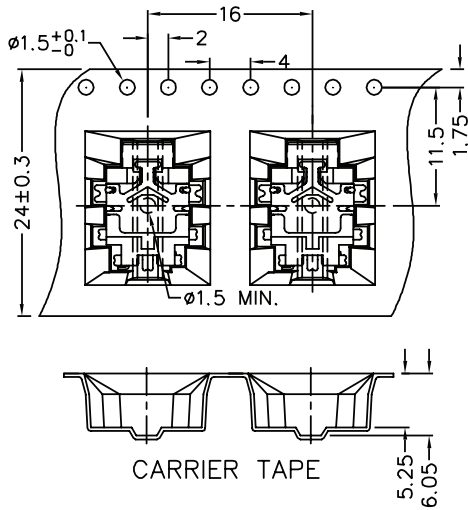

REVISION HISTORY

rev.	description	date
1.0	initial release	05/01/2006
1.01	new template applied	01/27/2012
1.02	added TR package option	11/01/2012
1.03	added storage and drying conditions, and tape and reel packaging details	02/15/2018
1.04	brand update	10/04/2019
1.05	discontinued model SJ1-42535RS-SMT-TR; logo, datasheet style update	08/18/2022

The revision history provided is for informational purposes only and is believed to be accurate.



CUI Devices offers a one (1) year limited warranty. Complete warranty information is listed on our website.

CUI Devices reserves the right to make changes to the product at any time without notice. Information provided by CUI Devices is believed to be accurate and reliable. However, no responsibility is assumed by CUI Devices for its use, nor for any infringements of patents or other rights of third parties which may result from its use.

CUI Devices products are not authorized or warranted for use as critical components in equipment that requires an extremely high level of reliability. A critical component is any component of a life support device or system whose failure to perform can be reasonably expected to cause the failure of the life support device or system, or to affect its safety or effectiveness.

cuidevices.com