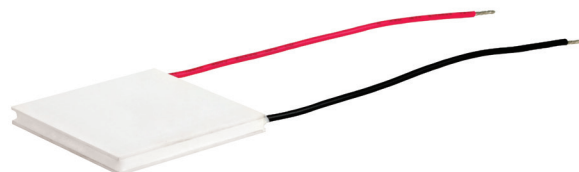

**SERIES:** CP85 | **DESCRIPTION:** PELTIER MODULE**FEATURES**

- arcTEC™ structure on select models
- solid state device
- precise temperature control
- quiet operation

**MODEL**

MODEL	input voltage <sup>1</sup>	input current <sup>2</sup>	internal resistance <sup>3</sup>	output Qmax <sup>4</sup>		output ΔTmax <sup>5</sup>	
	max [Vdc]	max [A]	typ [Ω±10%]	T <sub>h</sub> =27°C [W]	T <sub>h</sub> =50°C [W]	T <sub>h</sub> =27°C [°C]	T <sub>h</sub> =50°C [°C]
CP85204035	7.6	8.5	0.75	37.4	41.8	68	75
CP85301535	4.2	8.5	0.41	20.0	22.3	68	75
CP85435 <sup>6</sup>	24.1	8.5	2.28	118	130	68	75
CP85138	2.1	8.5	0.20	10.0	11.1	68	75
CP85238	3.8	8.5	0.40	18.0	20.1	68	75
CP85338	8.6	8.5	0.90	42.0	46.9	68	75
CP85438	15.4	8.5	1.50	75.0	83.9	68	75

Notes: 1. Maximum voltage at ΔT max and T<sub>h</sub>=27°C  
 2. Maximum current to achieve ΔT max  
 3. Measured by AC 4-terminal method at 25°C  
 4. Maximum heat absorbed at cold side occurs at I<sub>max</sub>, V<sub>max</sub>, and ΔT=0°C  
 5. Maximum temperature difference occurs at I<sub>max</sub>, V<sub>max</sub>, and Q=0W (ΔT max measured in a vacuum at 1.3 Pa)  
 6. Designed with arcTEC™ structure

## SPECIFICATIONS

parameter	conditions/description	min	typ	max	units
solder melting temperature	connection between thermoelectric pairs	235			°C
assembly compression				1	MPa
hot side plate				80	°C
RoHS	yes				

## MECHANICAL DRAWING

units: mm

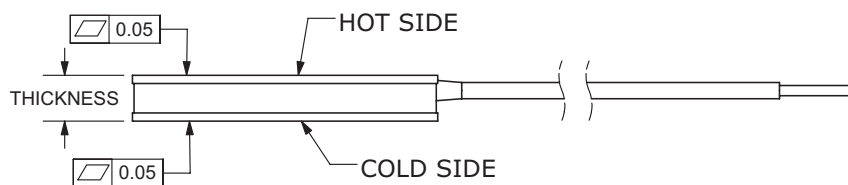

	MATERIAL	PLATING
ceramic plate	96% $Al_2O_3$	
wire leads	20 AWG	tin
sealer	silicon rubber 703 RTV (between cold and hot side plates)	
joint cover	silicon rubber 703 RTV	
marking	P/N & S/N printed on cold side surface	

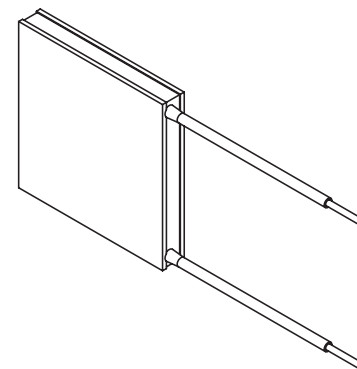
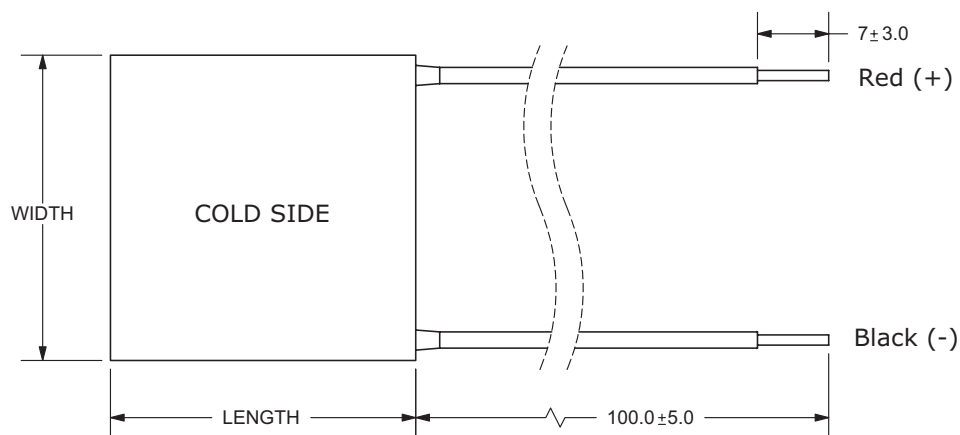

MODEL NO.	LENGTH [mm]	WIDTH [mm]	THICKNESS [mm]
CP85204035	20 ±0.3	40 ±0.3	3.5 ±0.1
CP85301535	30 ±0.3	15 ±0.3	3.5 ±0.1
CP85435	40 ±0.3	40 ±0.3	3.5 ±0.1
CP85138	15 ±0.3	15 ±0.3	3.74 ±0.1
CP85238	20 ±0.3	20 ±0.3	3.74 ±0.1
CP85338	30 ±0.3	30 ±0.3	3.74 ±0.1
CP85438	40 ±0.3	40 ±0.3	3.74 ±0.1

## CP85204035 PERFORMANCE (Th=27°C)

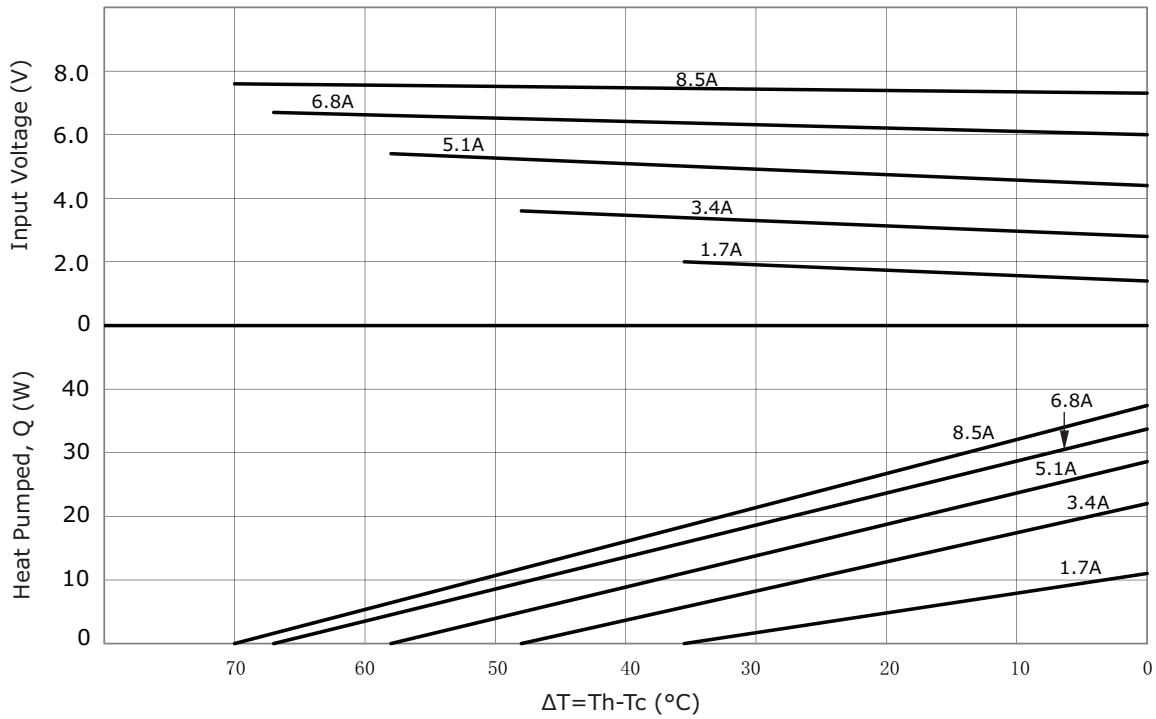

## CP85204035 PERFORMANCE (Th=50°C)

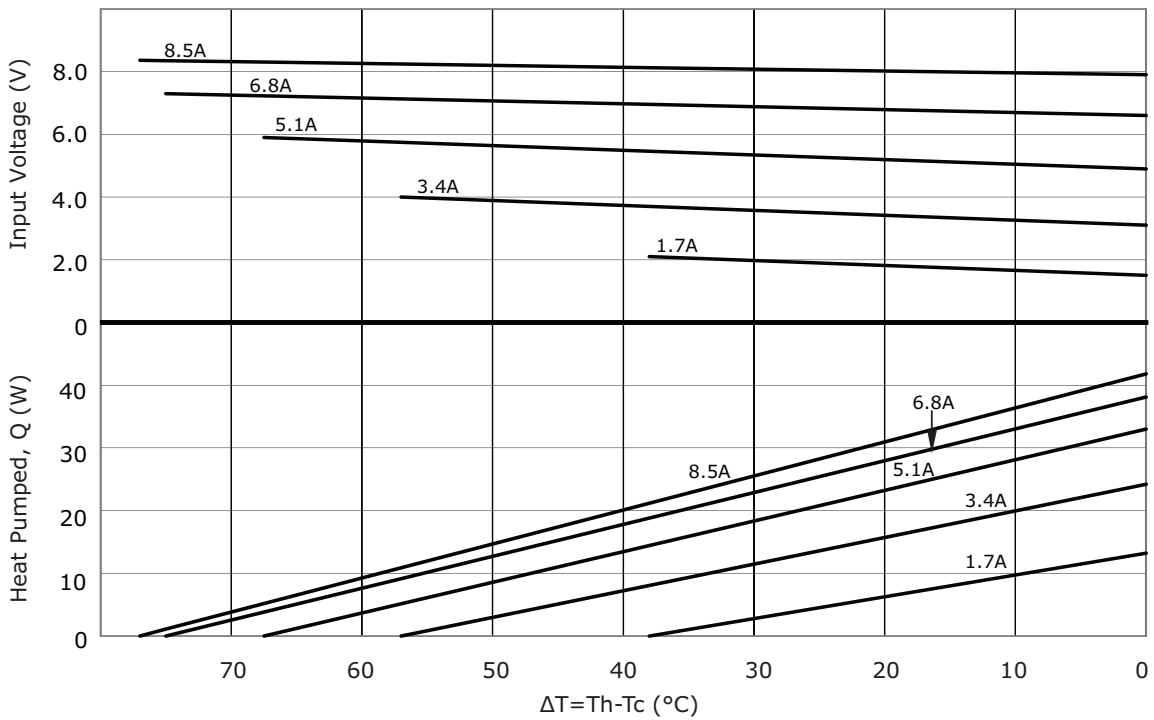

## CP85301535 PERFORMANCE (Th=27°C)

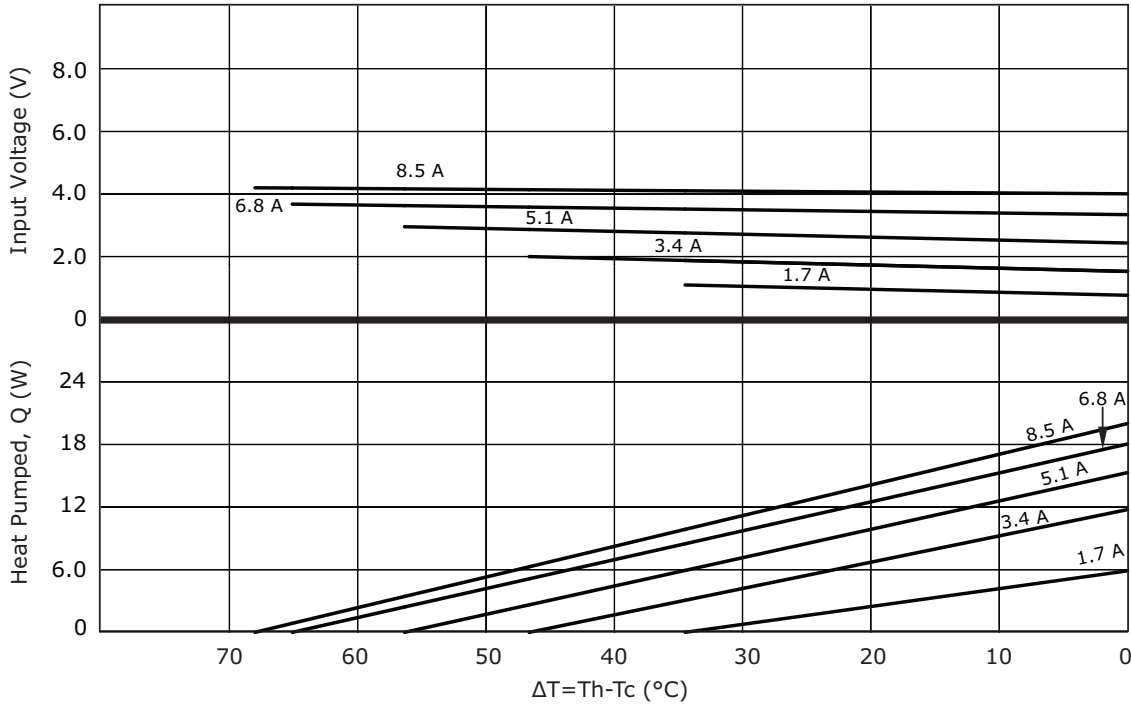

## CP85301535 PERFORMANCE (Th=50°C)

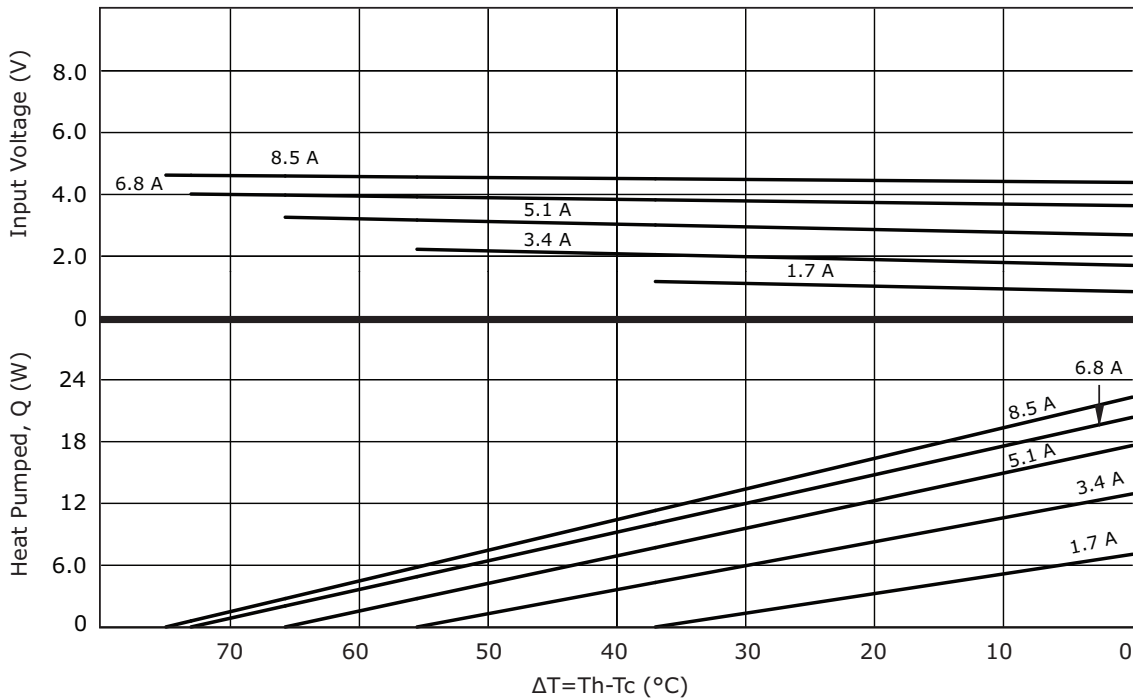

## CP85435 PERFORMANCE (Th=27°C)

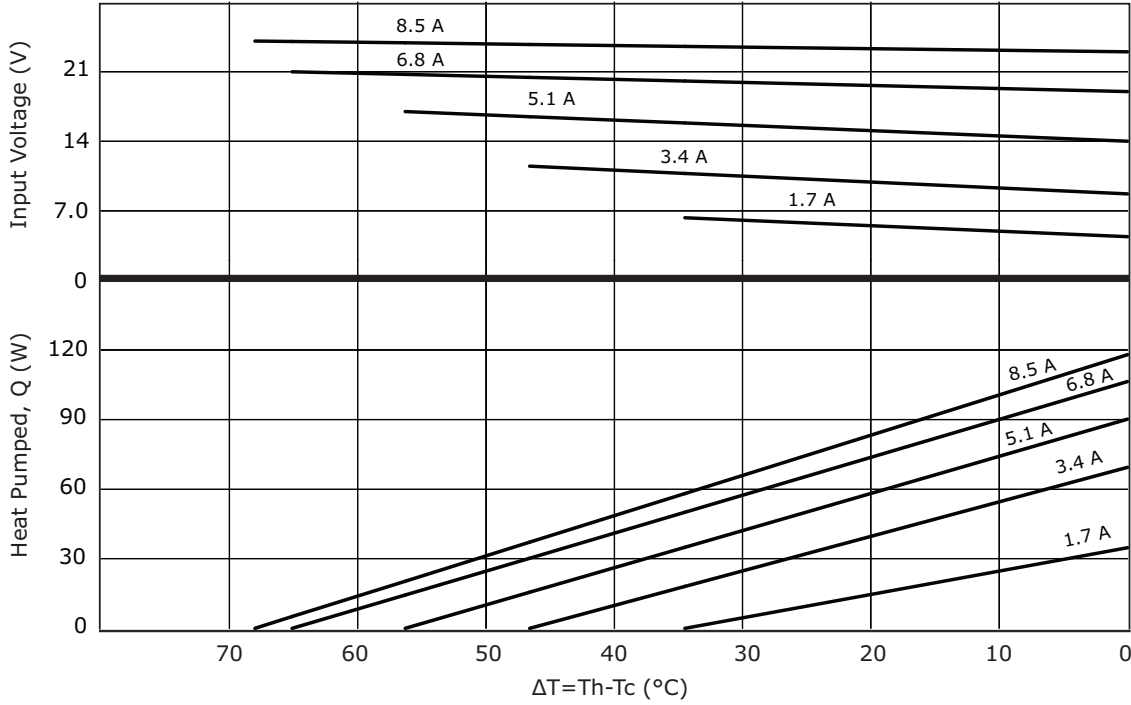

## CP85435 PERFORMANCE (Th=50°C)

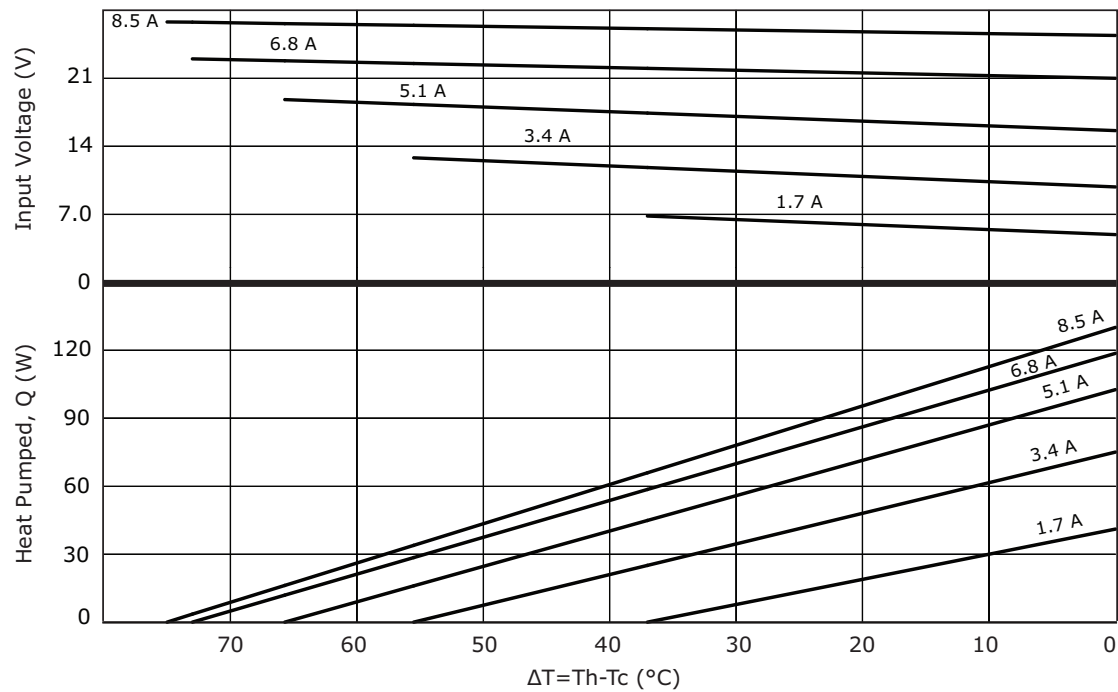

## CP85138 PERFORMANCE (Th=27°C)

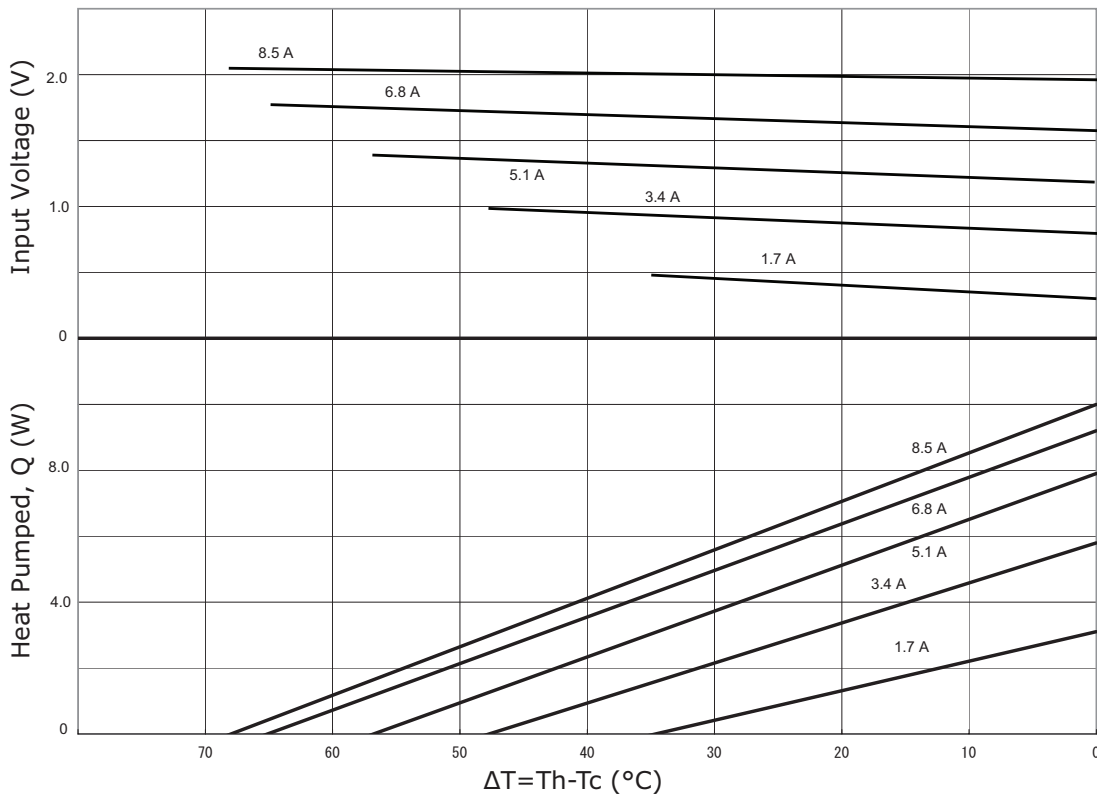

## CP85138 PERFORMANCE (Th=50°C)

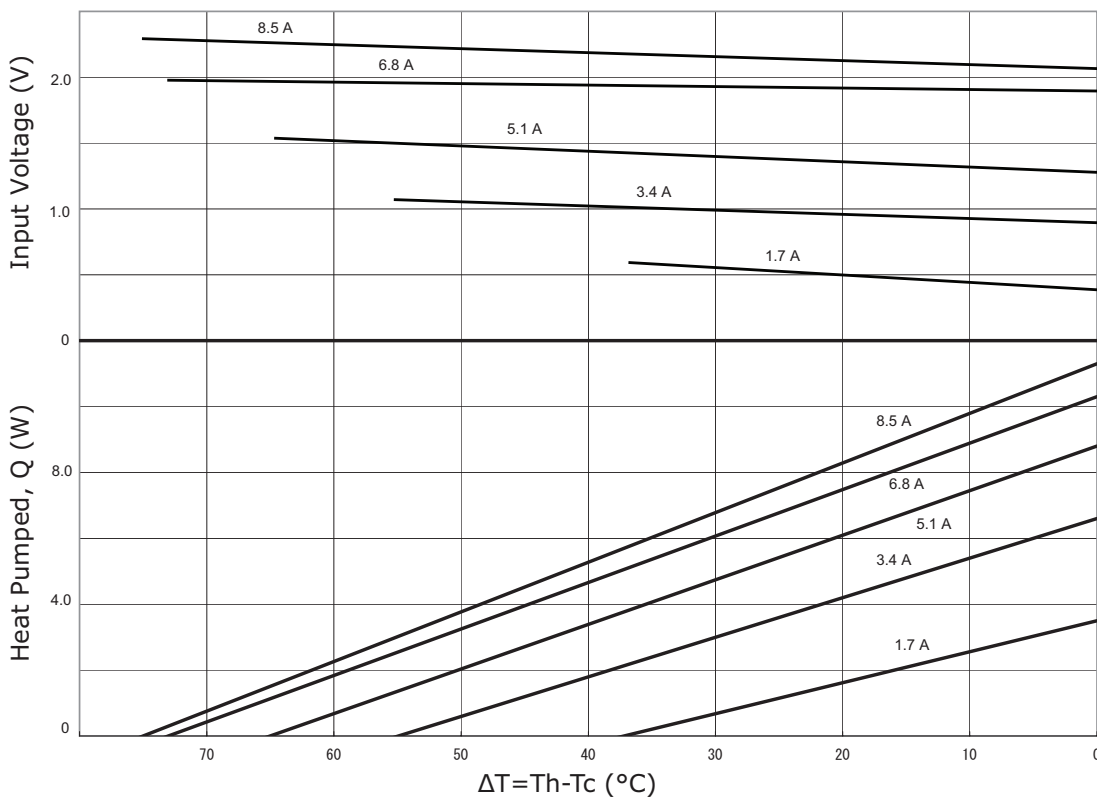

## CP85238 PERFORMANCE (Th=27°C)

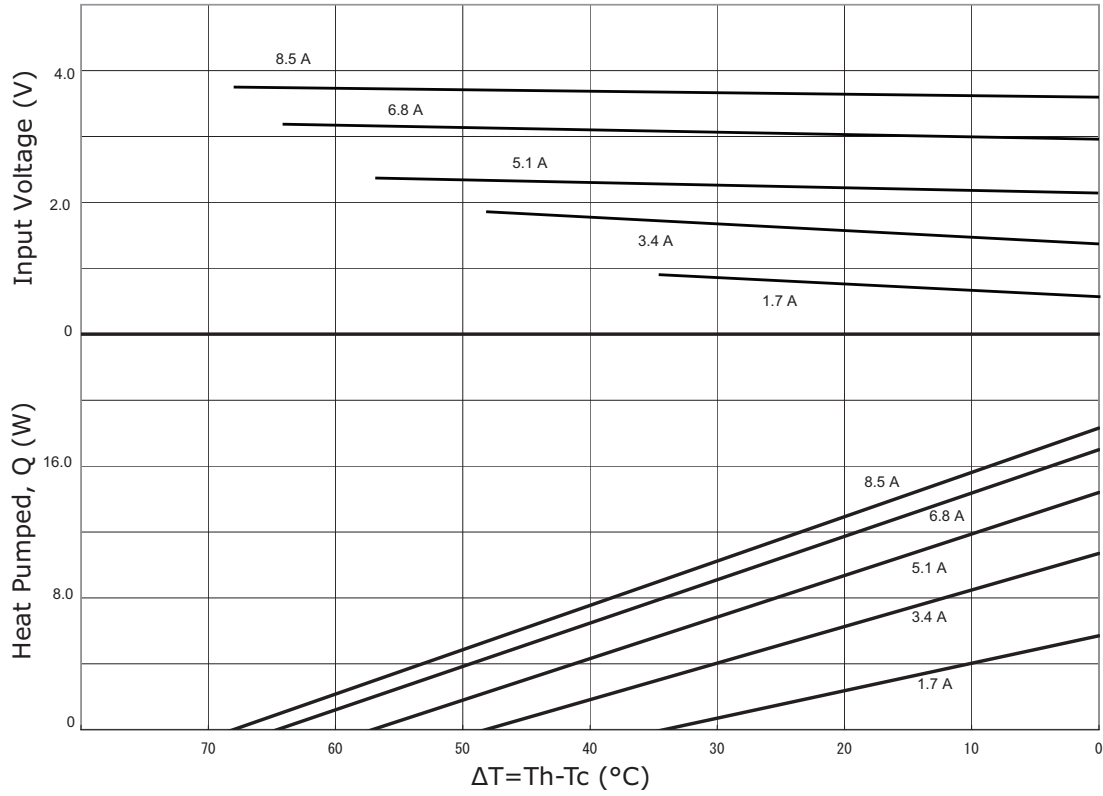

## CP85238 PERFORMANCE (Th=50°C)

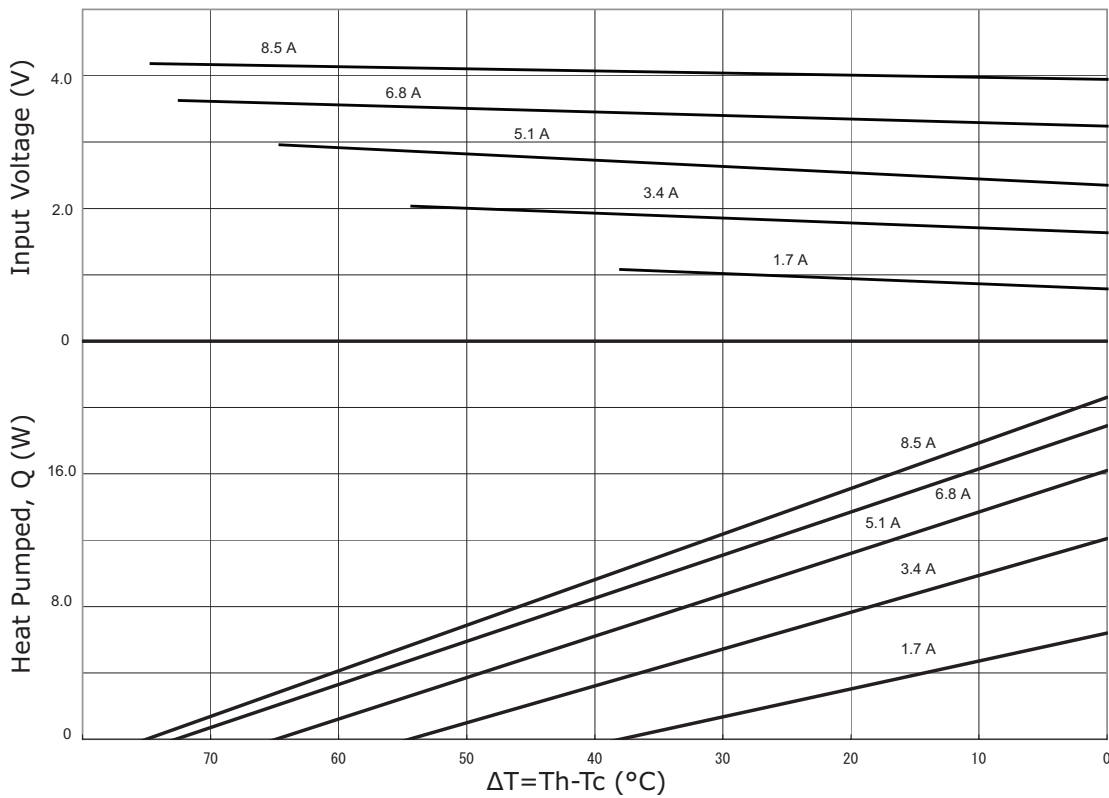

## CP85338 PERFORMANCE (Th=27°C)

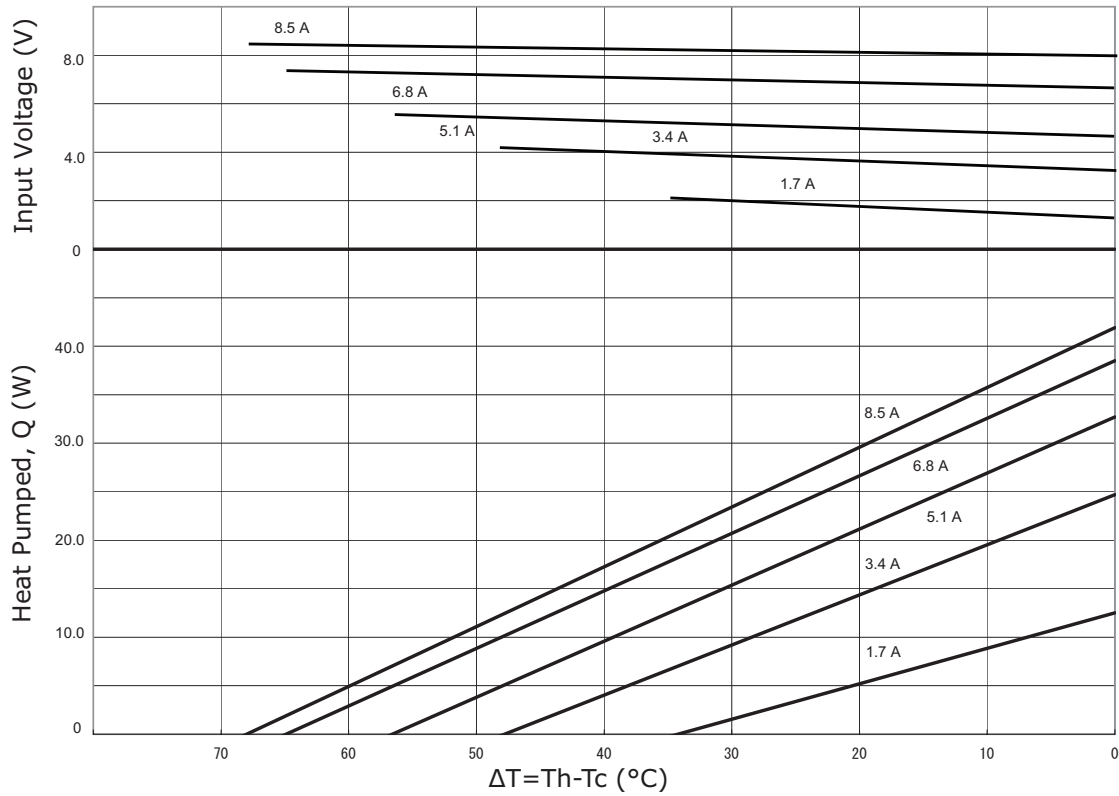

## CP85338 PERFORMANCE (Th=50°C)

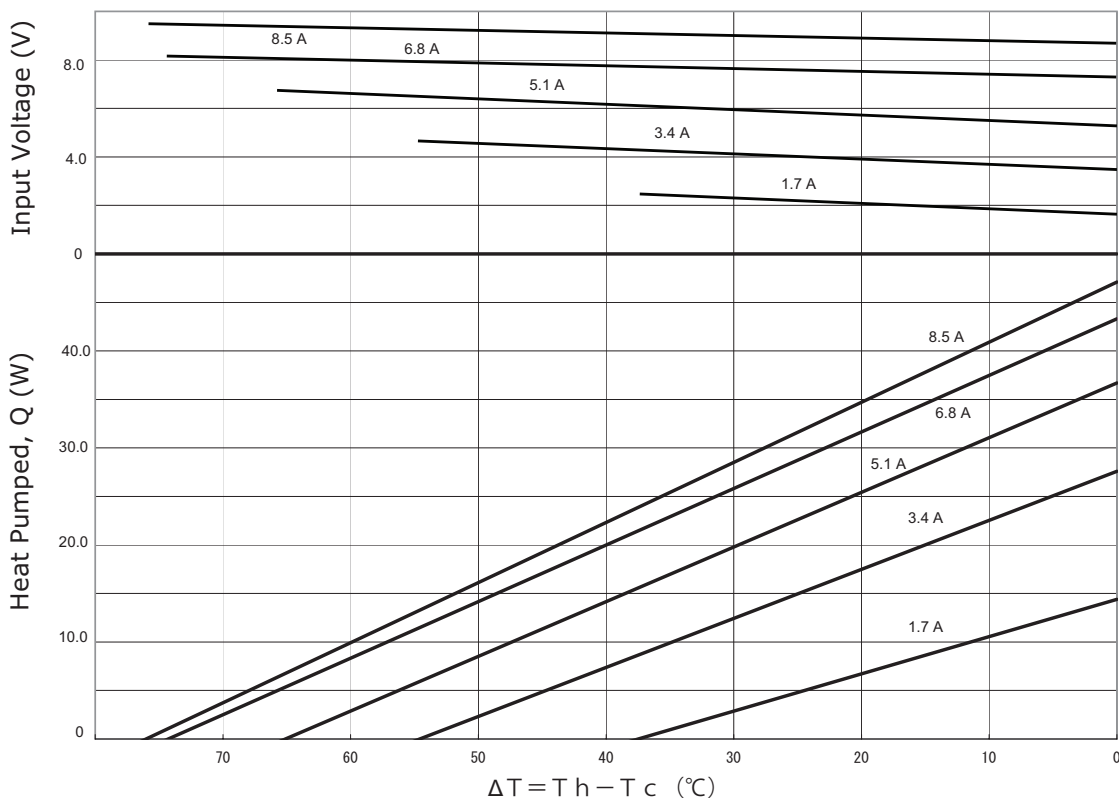



## CP85438 PERFORMANCE (Th=27°C)

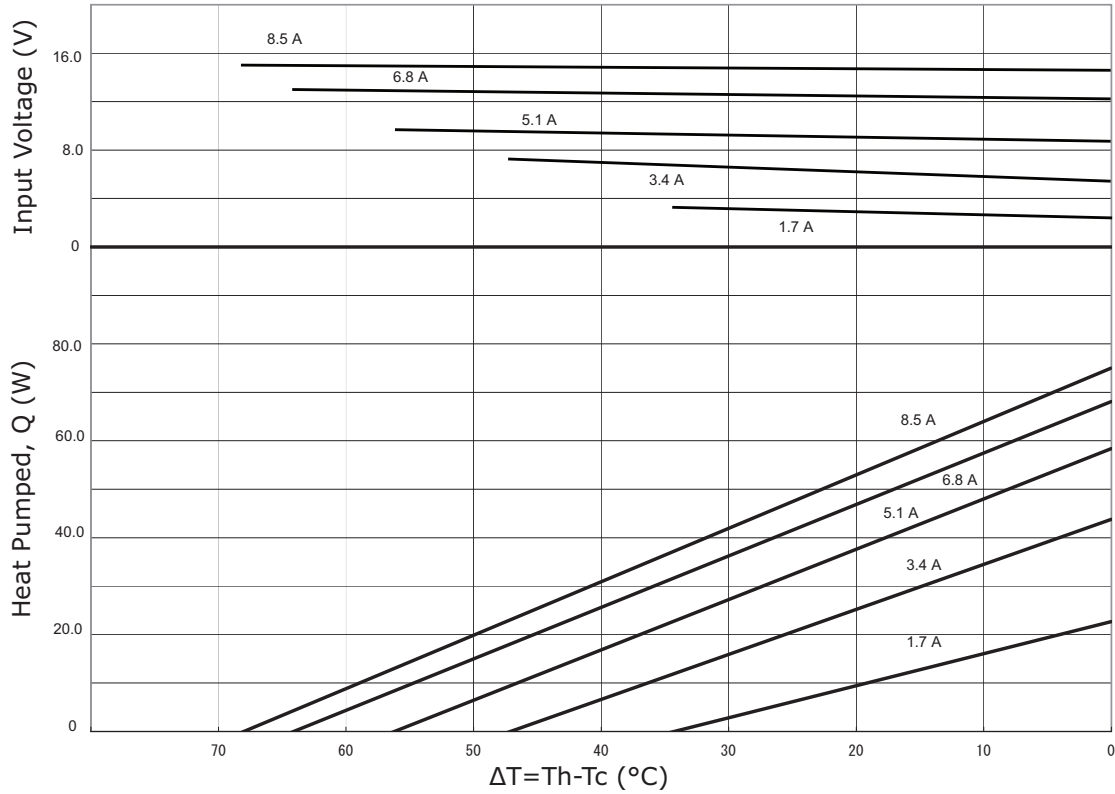

## CP85438 PERFORMANCE (Th=50°C)

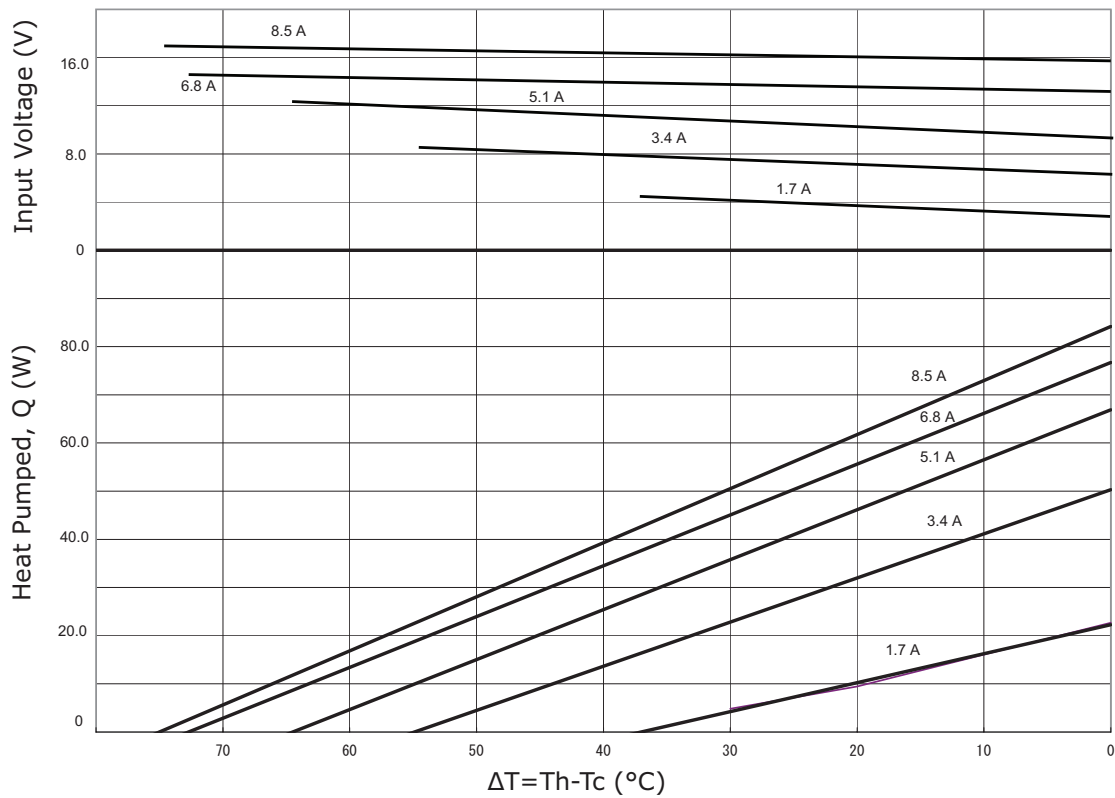

## REVISION HISTORY

rev.	description	date
1.0	initial release	09/03/2009
1.01	applied new template	05/08/2012
1.02	added new models	09/08/2016
1.03	changed to higher temperature solder used in model CP85204035	11/29/2017
1.04	changed thickness of CP85138, CP85238, CP85338, CP85438, CP85301535, CP85435 models	09/19/2018
1.05	changed thickness of model CP85204035	12/03/2018
1.06	brand update	10/28/2019
1.07	updated datasheet	11/30/2020
1.08	logo, datasheet style update	08/05/2022

The revision history provided is for informational purposes only and is believed to be accurate.



CUI Devices offers a one (1) year limited warranty. Complete warranty information is listed on our website.

CUI Devices reserves the right to make changes to the product at any time without notice. Information provided by CUI Devices is believed to be accurate and reliable. However, no responsibility is assumed by CUI Devices for its use, nor for any infringements of patents or other rights of third parties which may result from its use.

CUI Devices products are not authorized or warranted for use as critical components in equipment that requires an extremely high level of reliability. A critical component is any component of a life support device or system whose failure to perform can be reasonably expected to cause the failure of the life support device or system, or to affect its safety or effectiveness.

[cuidevices.com](http://cuidevices.com)