



ON Semiconductor®

<http://onsemi.com>

LV8746V

Bi-CMOS IC

PWM Constant-Current Control Stepper Motor Driver

Overview

The LV8746V is a stepper motor driver corresponding to the Quarter-step excitation drive that the selection of CLK-IN input and a parallel input is possible. It is ideally suited for driving stepper motors used in office equipment and amusement applications.

Function

- PWM current control stepper motor driver incorporated.
- BiCDMOS process IC
- Low on resistance (upper side : 0.84Ω ; lower side : 0.7Ω ; total of upper and lower : 1.54Ω ; Ta = 25°C, I_O = 1A)
- Excitation mode can be set to Full-step, Half-step Full torque, Half-step, or Quarter-step
- CLK-IN input and a parallel input can be selected.
- Motor current selectable in four steps
- Output short-circuit protection circuit (selectable from latch-type or auto-reset-type) incorporated
- Unusual condition warning output pins
- No control supply required

Specifications

Absolute Maximum Ratings at Ta = 25°C

Parameter	Symbol	Conditions	Ratings	Unit
Supply voltage	VM max	VM, VM1, VM2	38	V
Output peak current	I _O peak	tw ≤ 10ms, duty 20% , Per 1ch	1.2	A
Output current	I _O max	Per 1ch	1	A
Logic input voltage	V _{IN}		-0.3 to +6	V
EMO input voltage	Vemo		-0.3 to +6	V
Allowable power dissipation	Pd max	*	3.1	W
Operating temperature	Topr		-20 to +85	°C
Storage temperature	Tstg		-55 to +150	°C

* Specified circuit board : 90.0mm×90.0mm×1.6mm, glass epoxy 2-layer board, with backside mounting.

Caution 1) Absolute maximum ratings represent the value which cannot be exceeded for any length of time.

Caution 2) Even when the device is used within the range of absolute maximum ratings, as a result of continuous usage under high temperature, high current, high voltage, or drastic temperature change, the reliability of the IC may be degraded. Please contact us for the further details.

Stresses exceeding Maximum Ratings may damage the device. Maximum Ratings are stress ratings only. Functional operation above the Recommended Operating Conditions is not implied. Extended exposure to stresses above the Recommended Operating Conditions may affect device reliability.

Allowable Operating Ratings at Ta = 25°C

Parameter	Symbol	Conditions	Ratings	Unit
Supply voltage range	VM	VM, VM1, VM2	9 to 35	V
Logic input voltage	V _{IN}	ST, OE/I12, DM, MD1/I02, MD2/PH2, FR/I11, S TP/I01, RST/PH1, ATT1, ATT2	0 to 5.5	V
VREF input voltage range	VREF		0 to 3	V

ORDERING INFORMATION

See detailed ordering and shipping information on page 24 of this data sheet.

LV8746V

Electrical Characteristics at Ta = 25°C, VM = 24V, VREF = 1.5V

Parameter	Symbol	Conditions	Ratings			Unit	
			min	typ	max		
Standby mode current drain	IMst	ST = "L", I(VM)+I(VM1)+I(VM2)		190	300	μA	
Current drain	IM	ST = "H", OE = "L", with no load , I(VM)+I(VM1)+I(VM2)		3.3	5	mA	
VREG5 output voltage	Vreg5	IO = -1mA	4.5	5	5.5	V	
Thermal shutdown temperature	TSD	Design guarantee	150	180	210	°C	
Thermal hysteresis width	ΔTSD	Design guarantee		40		°C	
Motor driver							
Output on resistance	Ronu	IO = 1A, Upper-side on resistance		0.84	1.1	Ω	
	Rond	IO = 1A, Lower-side on resistance		0.7	0.9	Ω	
Output leakage current	IOleak	VM=35V			50	μA	
Diode forward voltage	VD	ID = -1A		1.0	1.3	V	
Logic pin input current(ST)	IINL	VIN = 0.8V	3	8	15	μA	
	IINH	VIN = 5V	50	78	110	μA	
Logic pin input current(Except ST)	IINL	OE/I12,DM,MD1/I02,MD2/PH2,FR/I11, STP/I01,RST/PH1,ATT1,ATT2, VIN = 0.8V	3	8	15	μA	
	IINH	VIN = 5V	30	50	70	μA	
Logic input voltage	High	VINh	ST,OE/I12,DM,MD1/I02,MD2/PH2,FR/I11,STP/I01,RST/PH1,ATT1,ATT2		5.5	V	
	Low	VINl			0.8	V	
Current setting comparator threshold voltage (CLK-IN input)	Quarter step resolution	Vtdac0_W	Step 0 (When initialized : channel 1 comparator level)	0.29	0.3	0.31	V
		Vtdac1_W	Step 1 (Initial state+1)	0.29	0.3	0.31	V
		Vtdac2_W	Step 2 (Initial state+2)	0.185	0.2	0.215	V
		Vtdac3_W	Step 3 (Initial state+3)	0.09	0.1	0.11	V
	Half step resolution	Vtdac0_M	Step 0 (When initialized : channel 1 comparator level)	0.29	0.3	0.31	V
		Vtdac2_M	Step 2 (Initial state+1)	0.185	0.2	0.215	V
	Half step resolution (Full torque)	Vtdac0_H	Step 0 (When initialized : channel 1 comparator level)	0.29	0.3	0.31	V
		Vtdac2_H	Step 2 (Initial state+1)	0.29	0.3	0.31	V
Full step resolution	Vtdac2_F	Step 2	0.29	0.3	0.31	V	
Current setting comparator threshold voltage (parallel input)	Vtdac11	I01 = H , I11 = H	0.29	0.3	0.31	V	
	Vtdac01	I01 = L , I11 = H	0.185	0.2	0.215	V	
	Vtdac10	I01 = H , I11 = L	0.09	0.1	0.11	V	
Current setting comparator threshold voltage (current attenuation rate switching)	Vtatt00	ATT1 = L, ATT2 = L	0.29	0.3	0.31	V	
	Vtatt01	ATT1 = H, ATT2 = L	0.185	0.2	0.215	V	
	Vtatt10	ATT1 = L, ATT2 = H	0.135	0.15	0.165	V	
	Vtatt11	ATT1 = H, ATT2 = H	0.09	0.1	0.11	V	
Chopping frequency	Fchop	Rchop = 20KΩ	45	62.5	75	kHz	
VREF pin input current	Iref	VREF = 1.5V	-0.5			μA	
Charge pump							
VG output voltage	VG		28	28.75	30	V	
Rise time	tONG	VG = 0.1μF , Between CP1-CP2 0.1uF ST = "H"→VG = VM+4V			0.5	mS	
Oscillator frequency	Fosc	Rchop = 20KΩ	90	125	150	kHz	
Output short-circuit protection							
EMO pin saturation voltage	Vsatemo	Iemo = 1mA		80	160	mV	
CEM pin charge current	Icem	Vcem = 0V	7	10	13	μA	
CEM pin threshold voltage	Vthcem		0.8	1.0	1.2	V	

LV8746V

Package Dimensions

unit : mm (typ)

3333A

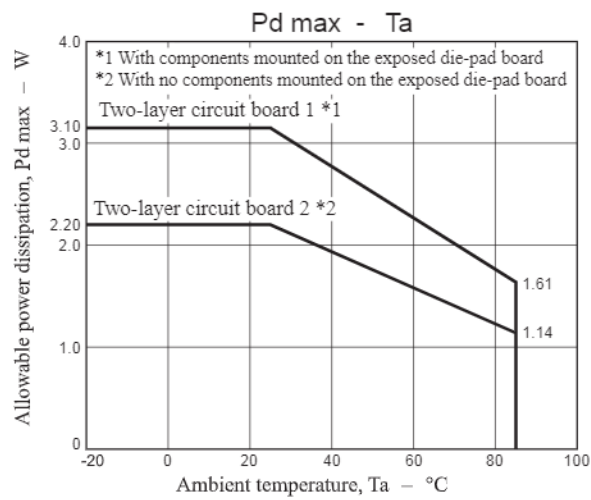
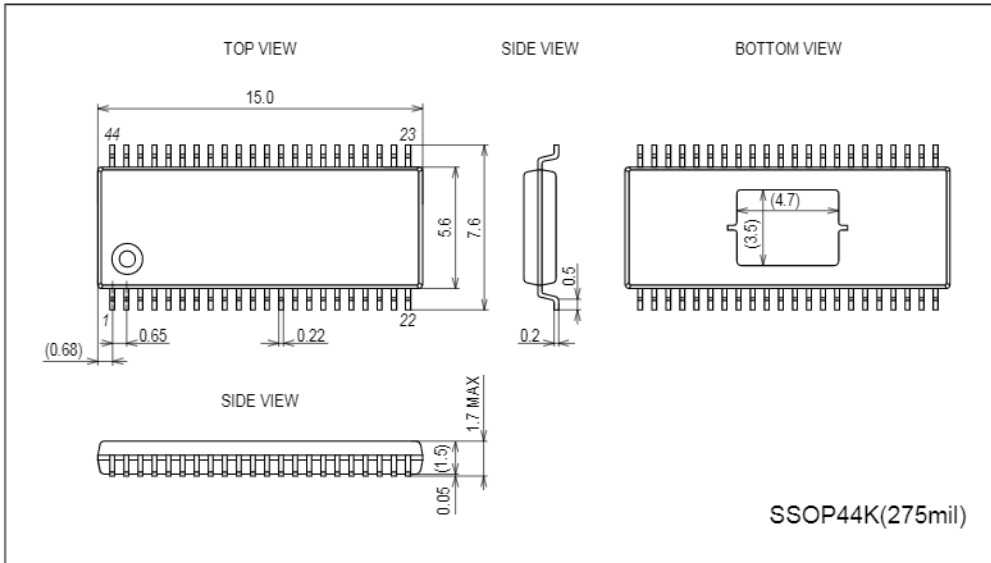

LV8746V

Substrate Specifications (Substrate recommended for operation of LV8746V)

Size : 90mm × 90mm × 1.6mm (two-layer substrate [2S0P])
Material : Glass epoxy
Copper wiring density : L1 = 85% / L2 = 90%

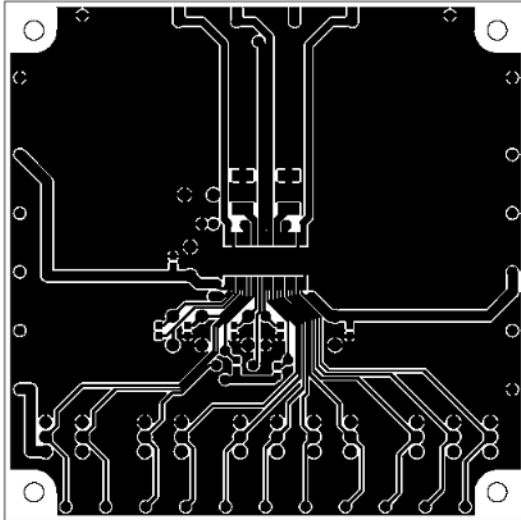

L1 : Copper wiring pattern diagram

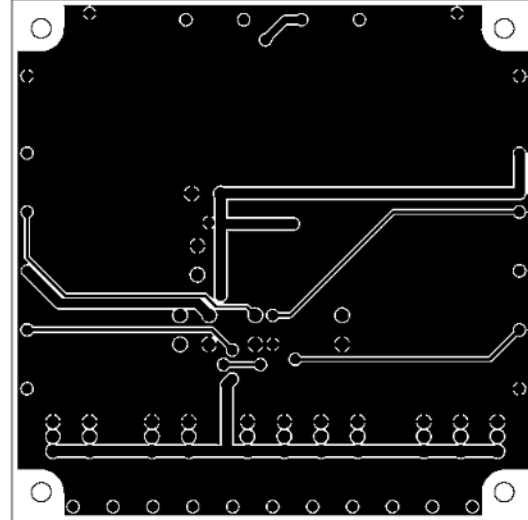

L2 : Copper wiring pattern diagram

Cautions

- 1) The data for the case with the Exposed Die-Pad substrate mounted shows the values when 90% or more of the Exposed Die-Pad is wet.
- 2) For the set design, employ the derating design with sufficient margin.
Stresses to be derated include the voltage, current, junction temperature, power loss, and mechanical stresses such as vibration, impact, and tension.
Accordingly, the design must ensure these stresses to be as low or small as possible.
The guideline for ordinary derating is shown below :
 - (1)Maximum value 80% or less for the voltage rating
 - (2)Maximum value 80% or less for the current rating
 - (3)Maximum value 80% or less for the temperature rating
- 3) After the set design, be sure to verify the design with the actual product.
Confirm the solder joint state and verify also the reliability of solder joint for the Exposed Die-Pad, etc.
Any void or deterioration, if observed in the solder joint of these parts, causes deteriorated thermal conduction, possibly resulting in thermal destruction of IC.

LV8746V

Pin Assignment

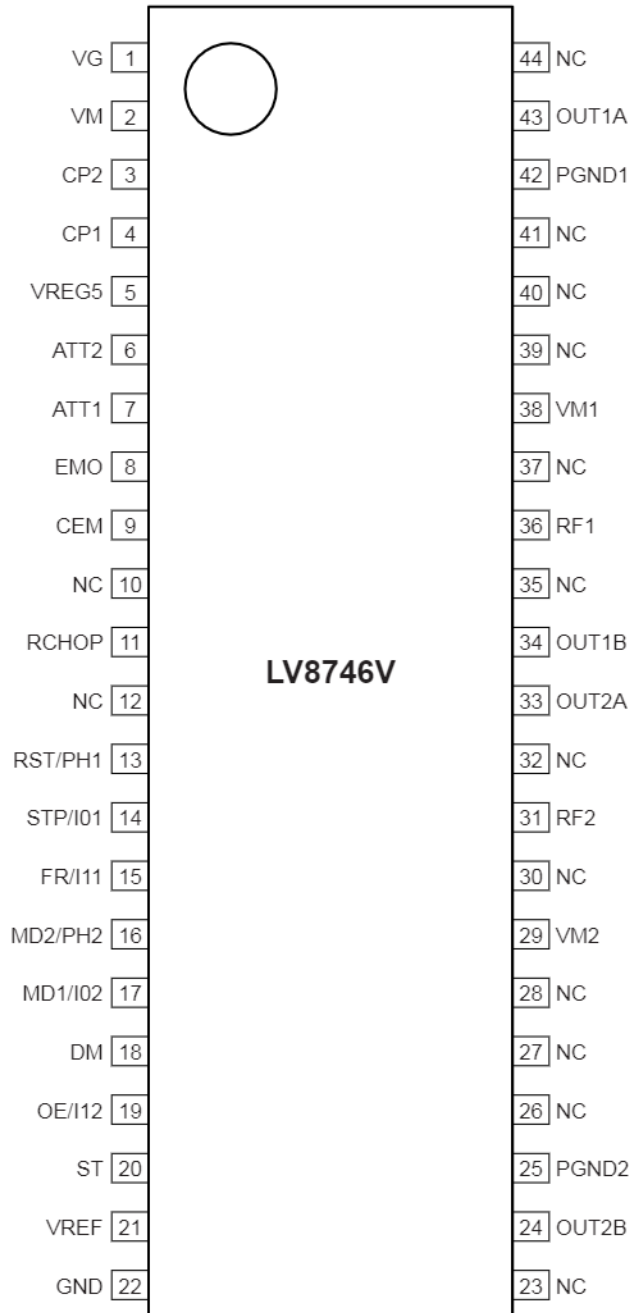

Top view

Block Diagram

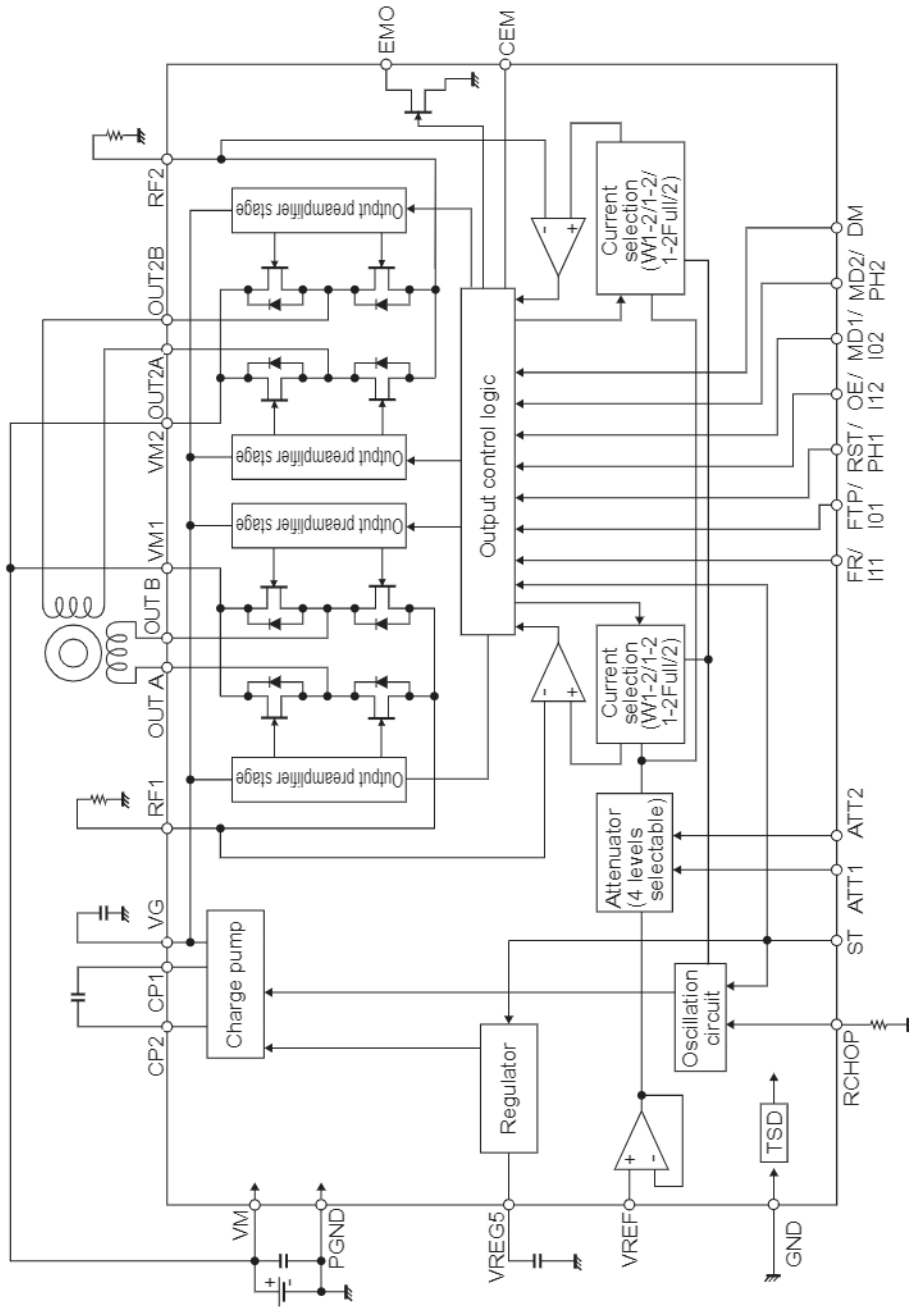

LV8746V

Pin Functions

Pin No.	Pin Name	Pin Function	Equivalent Circuit
6 7 13 14 15 16 17 18 19	ATT2 ATT1 RST/PH1 STP/I01 FR/I11 MD2/PH2 MD1/I02 DM OE/I12	Motor holding current switching pin. Motor holding current switching pin. CLK-IN is input , RESET input pin / Parallel is input , Channel 1 forward/reverse rotation pin. CLK-IN is input , STEP signal input pin / Parallel is input , Channel 1 output control input pin. CLK-IN is input , forward/reverse signal input pin / Parallel is input , Channel 1 output control input pin. CLK-IN is input , Excitation mode switching pin / Parallel is input , Channel 2 forward/reverse rotation pin. CLK-IN is input , Excitation mode switching pin / Parallel is input , Channel 2 output control input pin. Drive mode switching pin. CLK-IN is input , output enable signal input pin / Parallel is input , Channel 2 output control input pin.	
20	ST	Chip enable pin.	
24 25 42 29 31 33 34 36 38 43	OUT2B PGND2 PGND1 VM2 RF2 OUT2A OUT1B RF1 VM1 OUT1A	Channel 2 OUTB output pin. Power system ground pin2. Power system ground pin1. Channel 2 motor power supply connection pin. Channel 2 current-sense resistor connection pin. Channel 2 OUTA output pin. Channel 1 OUTB output pin. Channel 1 current-sense resistor connection pin. Channel 1 motor power supply pin. Channel 1 OUTA output pin.	

Continued on next page.

LV8746V

Continued from preceding page.

Pin No.	Pin Name	Pin Function	Equivalent Circuit
1 2 3 4	VG VM CP2 CP1	Charge pump capacitor connection pin. Motor power supply connection pin. Charge pump capacitor connection pin. Charge pump capacitor connection pin.	
21	VREF	Constant current control reference voltage input pin.	
5	VREG5	Internal power supply capacitor connection pin.	
8	EMO	Output short-circuit state warning output pin.	

Continued on next page.

LV8746V

Continued from preceding page.

Pin No.	Pin Name	Pin Function	Equivalent Circuit
9	CEM	Pin to connect the output short-circuit state detection time setting capacitor.	
11	RCHOP	Chopping frequency setting resistor connection pin.	
22	GND	Ground.	
10,12 23,26 27,28 30,32 35,37 39,40 41,44	NC	No Connection (No internal connection to the IC)	

Description of operation

1. Input Pin Function

1-1) Chip enable function

This IC is switched between standby and operating mode by setting the ST pin. In standby mode, the IC is set to power-save mode and all logic is reset. In addition, the internal regulator circuit and charge pump circuit do not operate in standby mode.

ST	Mode	Internal regulator	Charge pump
Low or Open	Standby mode	Standby	Standby
High	Operating mode	Operating	Operating



1-2) Input control method switching pin function

The IC input control method is switched by setting the DM pin. The CLK-IN input control and the parallel input control can be selected by setting the DM pin.

DM	Input control method
Low or Open	CLK-IN input control
High	Parallel input control

2. CLK-IN input control (DM = Low or Open)

2-1) STEP pin function

Input		Operating mode
ST	STP	
Low	*	Standby mode
High		Excitation step proceeds
High		Excitation step is kept

2-2) Excitation mode setting function

MD1	MD2	Micro-step resolution (Excitation mode)	Initial position	
			Channel 1	Channel 2
Low	Low	Full step (2 phase excitation)	100%	-100%
High	Low	Half step (1-2 phase excitation) Full torque	100%	0%
Low	High	Half step (1-2 phase excitation)	100%	0%
High	High	Quarter step (W1-2 phase excitation)	100%	0%

This is the initial position of each excitation mode in the initial state after power-on and when the counter is reset.

2-3) Setting constant-current control reference voltage

ATT1	ATT2	Current setting reference voltage
Low	Low	$V_{REF} / 5 \times 100\%$
High	Low	$V_{REF} / 5 \times 67\%$
Low	High	$V_{REF} / 5 \times 50\%$
High	High	$V_{REF} / 5 \times 33\%$

The voltage input to the VREF pin can be switched to four-step settings depending on the statuses of the two inputs, ATT1 and ATT2. This is effective for reducing power consumption when motor holding current is supplied.

Set current value calculation method.

The reference voltage is set by the voltage applied to the VREF pin and the two inputs ATT1 and ATT2. The output current (output current at a constant-current drive current ratio of 100%) can be set from this reference voltage and the RF resistance value.

$$I_{OUT} = (V_{REF}/5) \times (\text{current attenuation ratio}) / R_F \text{ resistance}$$

Example : At VREF of 1.5V, a reference voltage setting of 100% [(ATT1, ATT2) = (L, L)] and an RF resistance of 0.47Ω, the output current is set as shown below.

$$I_{OUT} = 1.5V/5 \times 100\%/0.47\Omega = 0.64A$$

2-4) Input Timing

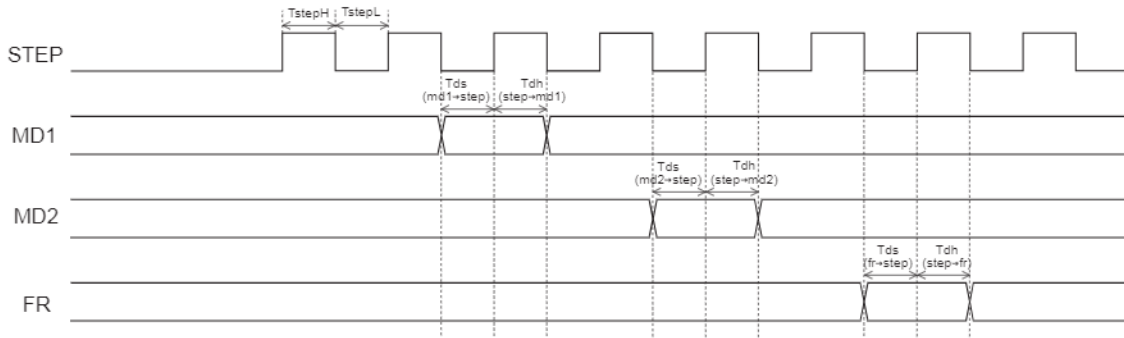

TstepH/TstepL : Clock H/L pulse width (min 500ns)
 Tds : Data set-up time (min 500ns)
 Tdh : Data hold time (min 500ns)

2-5) Blanking period

If, when exercising PWM constant-current chopping control over the motor current, the mode is switched from decay to charge, the recovery current of the parasitic diode may flow to the current sensing resistance, causing noise to be carried on the current sensing resistance pin, and this may result in erroneous detection. To prevent this erroneous detection, a blanking period is provided to prevent the noise occurring during mode switching from being received. During this period, the mode is not switched from charge to decay even if noise is carried on the current sensing resistance pin. In the blanking time for this IC, it is fixed one sixteenth of chopping cycle.

2-6) Reset function

RST	Operating mode
Low	Normal operation
High	Reset state

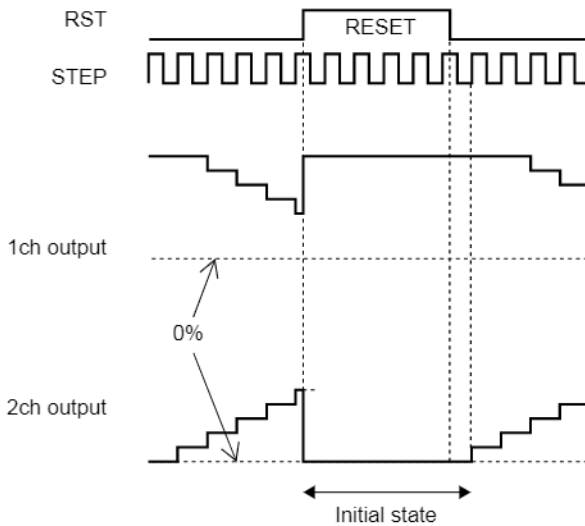

When the RST pin is set to High, the excitation position of the output is forcibly set to the initial state. When RST is then set to Low, the excitation position is advanced by the next STEP input.

2-7) Output enable function

OE	Operating mode
Low	Output ON
High	Output OFF

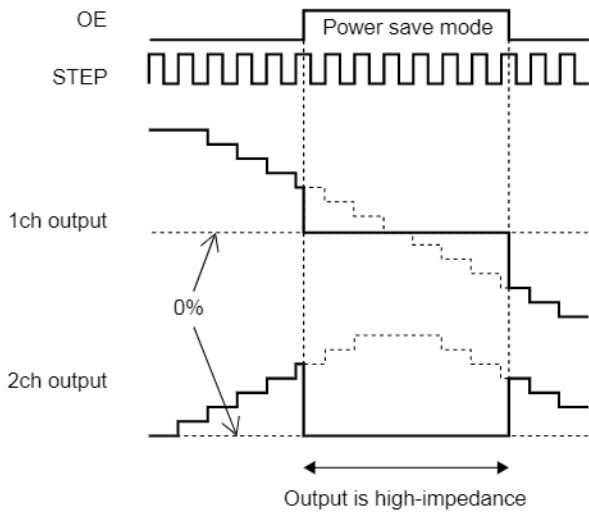

When the OE pin is set High, the output is forced OFF and goes to high impedance. However, the internal logic circuits are operating, so the excitation position proceeds when the STEP signal is input. Therefore, when OE is returned to Low, the output level conforms to the excitation position preceded by the STEP input.

2-8) Forward/reverse switching function

FR	Operating mode
Low	CW
High	CCW

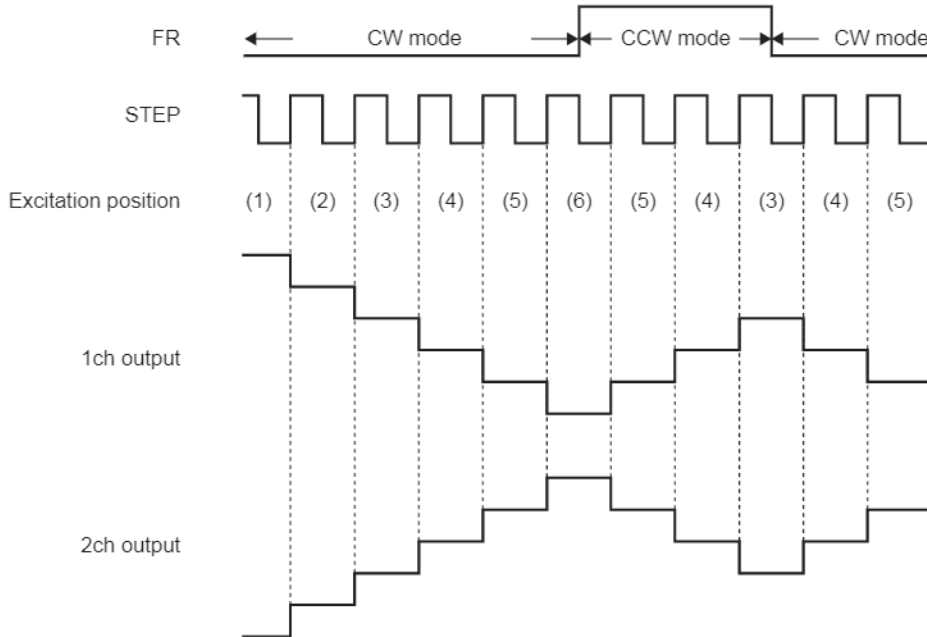

The internal D/A converter proceeds by one bit at the rising edge of the input STEP pulse. In addition, CW and CCW mode are switched by setting the FR pin. In CW mode, the channel 2 current phase is delayed by 90° relative to the channel 1 current. In CCW mode, the channel 2 current phase is advanced by 90° relative to the channel 1 current.

LV8746V

2-9) Chopping frequency setting

For constant-current control, chopping operation is made with the frequency determined by the external resistor. The chopping frequency to be set with the resistance connected to the RCHOP pin (pin 11) is as shown below.

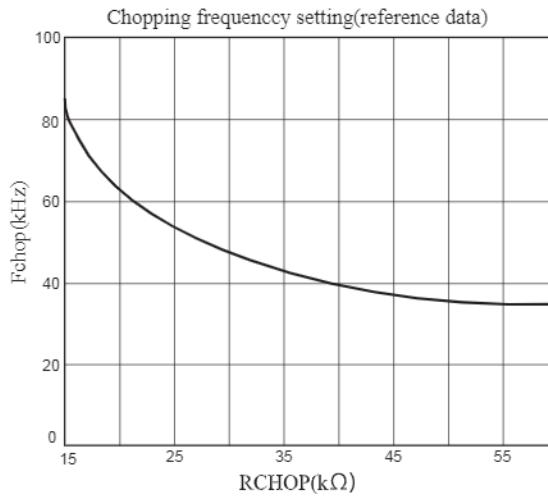

2-10) Output current vector locus (one step is normalized to 90 degrees)

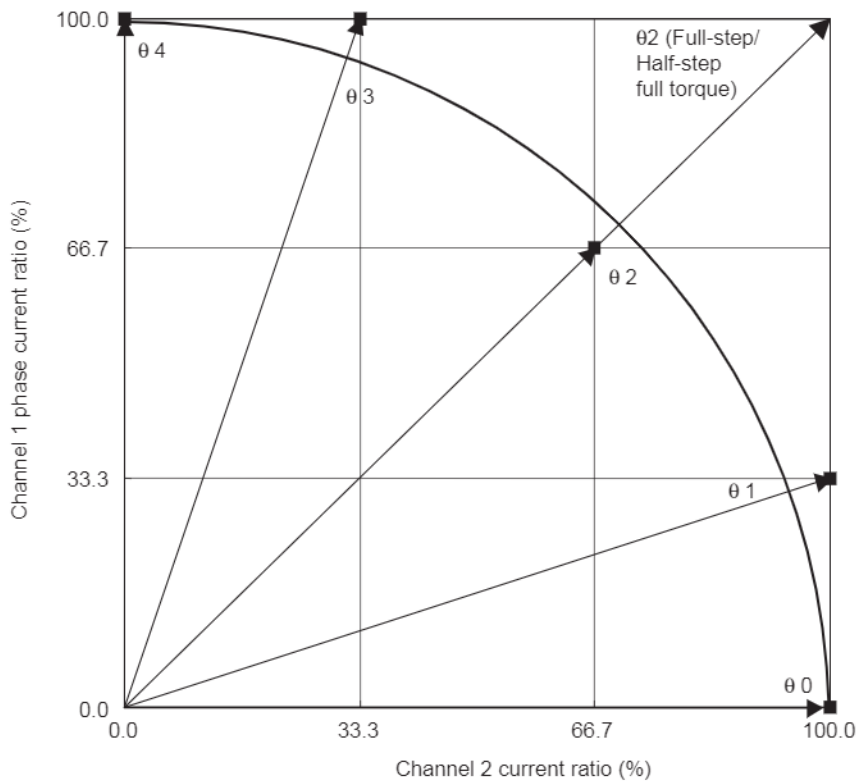

Setting current ration in each micro-step mode

STEP	Quarter-step (%)		Half-step (%)		Half-step full torque (%)		Full-step (%)	
	Channel 1	Channel 2	Channel 1	Channel 2	Channel 1	Channel 2	Channel 1	Channel 2
60	0	100	0	100	0	100		
61	33.3	100						
62	66.7	66.7	66.7	66.7	100	100	100	100
63	100	33.3						
64	100	0	100	0	100	0		

2-11) Typical current waveform in each excitation mode

Full step (CW mode)

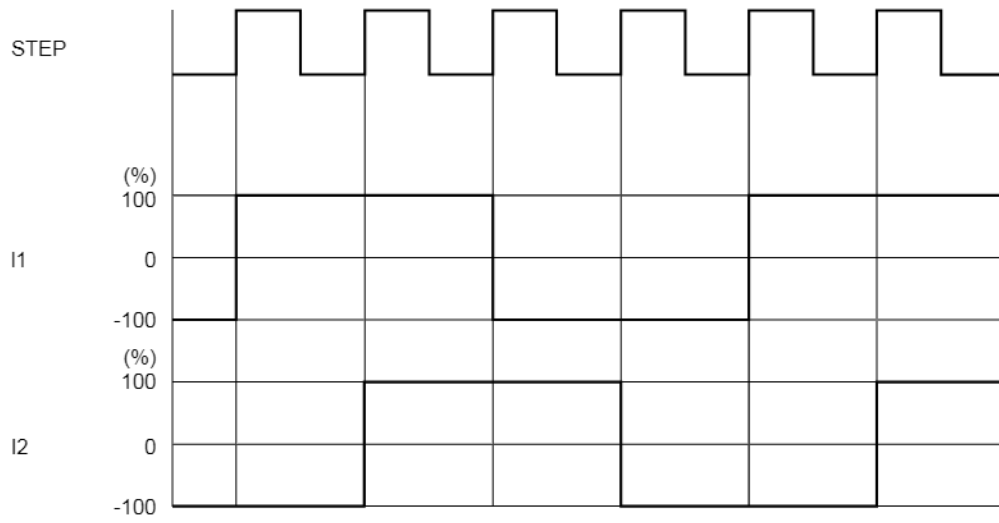

Half step Full torque (CW mode)

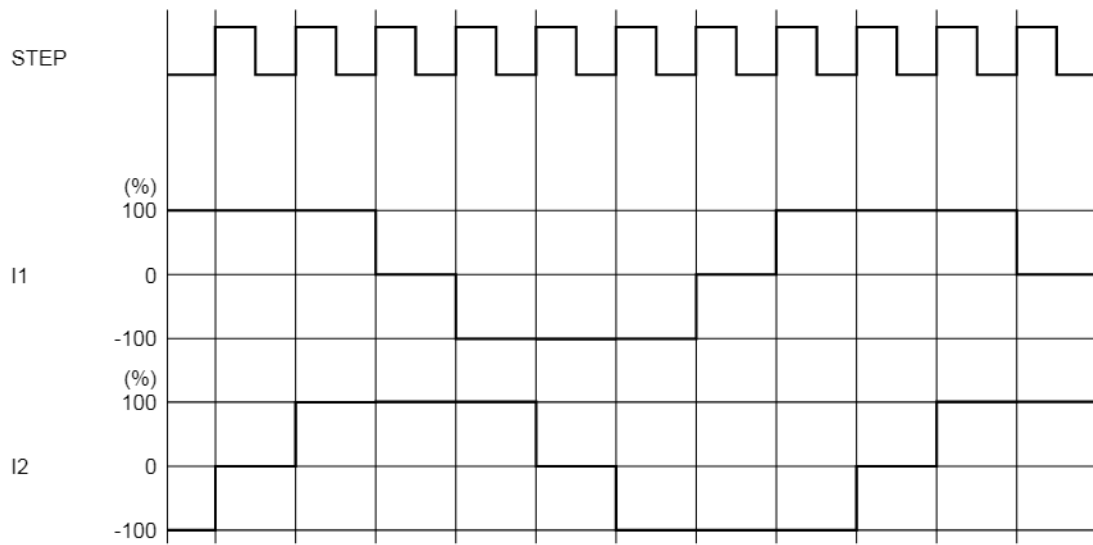

LV8746V

Half step (CW mode)

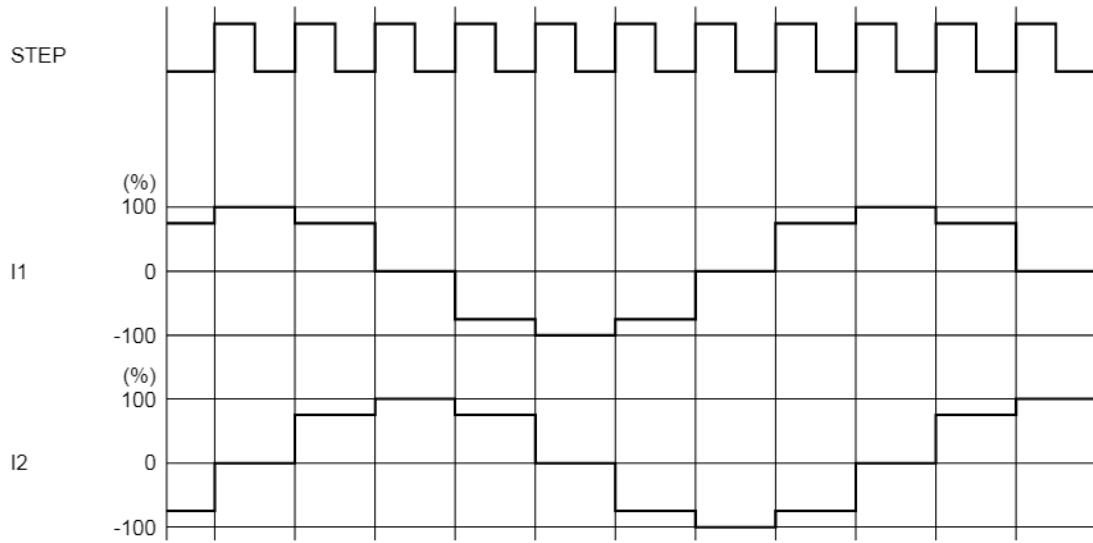

Quarter step (CW mode)

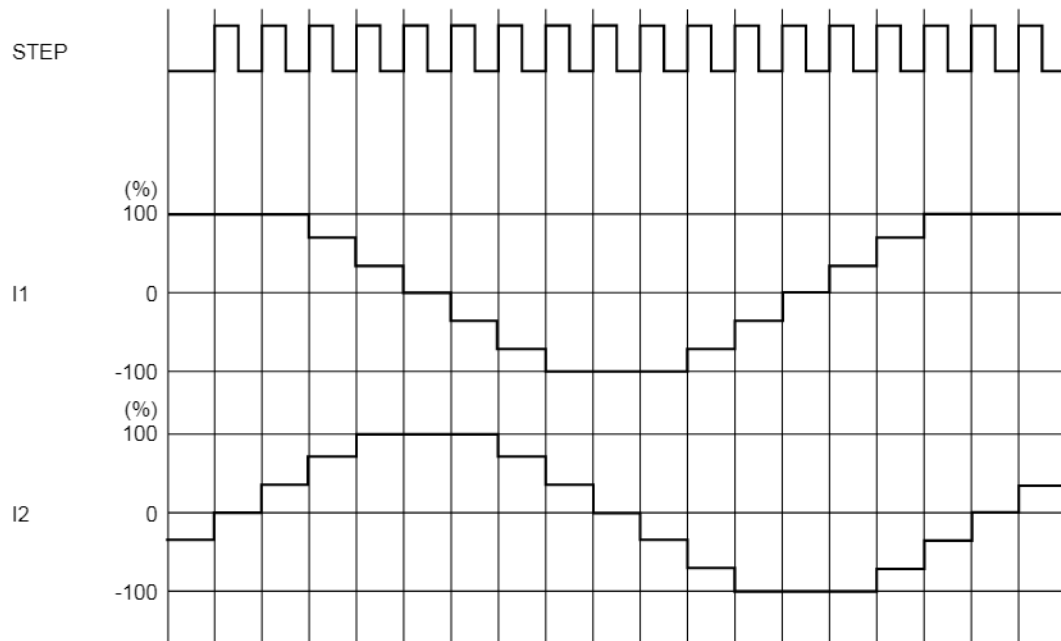

2-12) Current control operation specification

(Sine wave increasing direction)

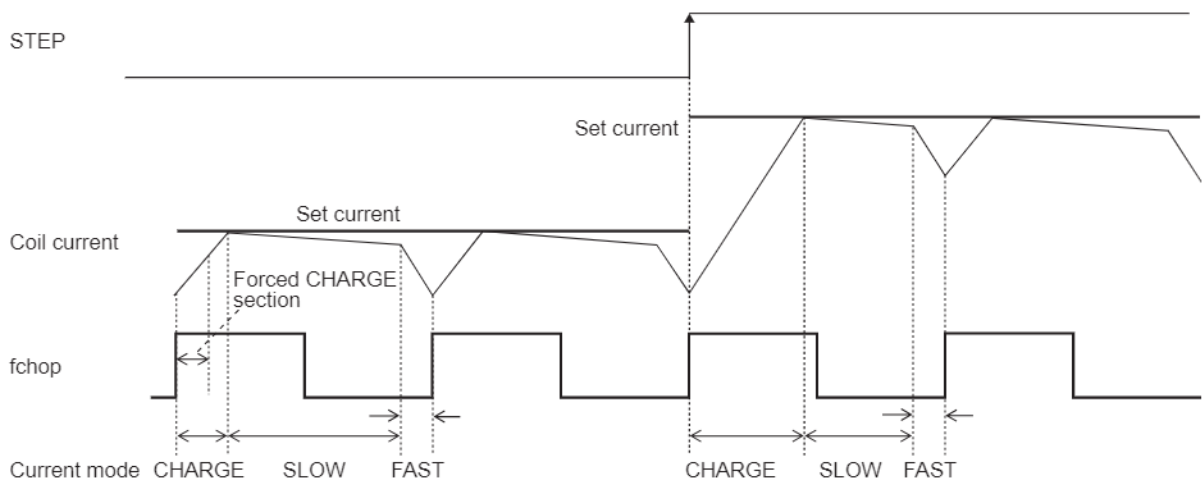

(Sine wave decreasing direction)

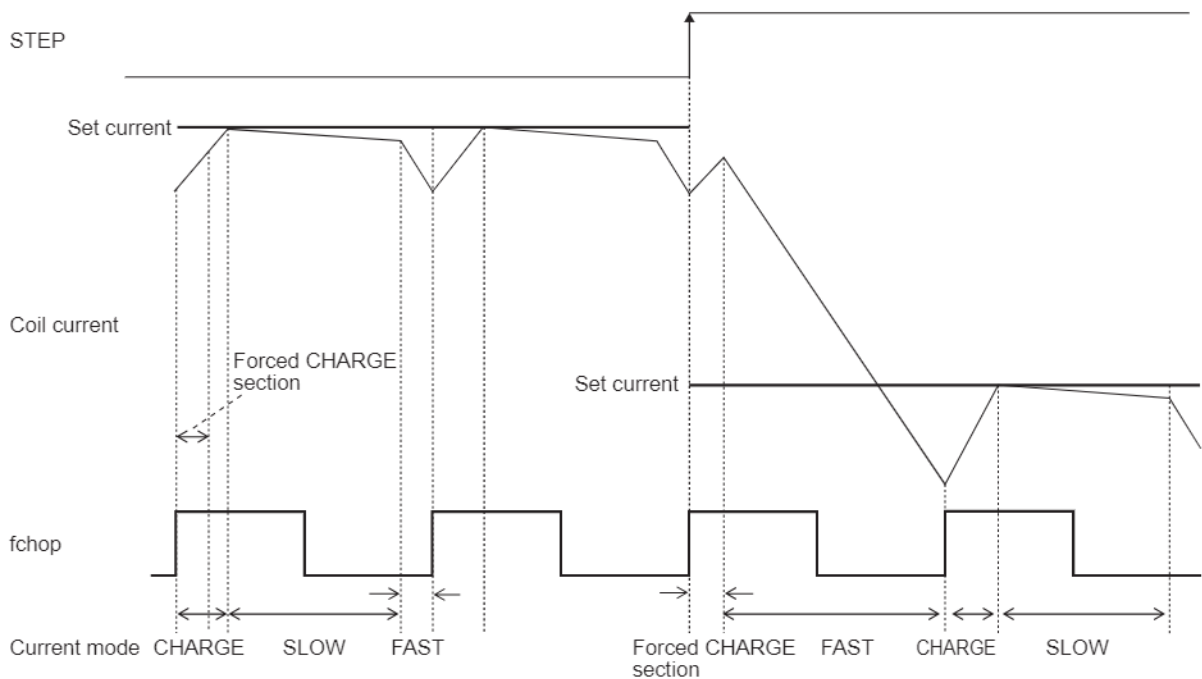

In each current mode, the operation sequence is as described below :

- At rise of chopping frequency, the CHARGE mode begins. (The section in which the CHARGE mode is forced regardless of the magnitude of the coil current (ICOIL) and set current (IREF) exists for 1/16 of one chopping cycle.)
- The coil current (ICOIL) and set current (IREF) are compared in this forced CHARGE section.

When $(ICOIL < IREF)$ state exists in the forced CHARGE section ;

CHARGE mode up to $ICOIL \geq IREF$, then followed by changeover to the SLOW DECAY mode, and finally by the FAST DECAY mode for the 1/16 portion of one chopping cycle.

When $(ICOIL < IREF)$ state does not exist in the forced CHARGE section;

The FAST DECAY mode begins. The coil current is attenuated in the FAST DECAY mode till one cycle of chopping is over.

Above operations are repeated. Normally, the SLOW (+FAST) DECAY mode continues in the sine wave increasing direction, then entering the FAST DECAY mode till the current is attenuated to the set level and followed by the SLOW DECAY mode.

3.Parallel input control (DM-High)

3-1) Parallel input control logic

I01(02)	I11(12)	Output current (I _O)
Low	Low	0
High	Low	$I_O = ((V_{REF}/5)/R_F) \times 1/3$
Low	High	$I_O = ((V_{REF}/5)/R_F) \times 2/3$
High	High	$I_O = (V_{REF}/5)/R_F$

PH1(2)	current direction
Low	OUTB → OUTA
High	OUTA → OUTB

3-2) Setting constant-current control reference voltage

The constant current control standard voltage setting function is the same specification as the CLK-IN input control.

3-3) Current control function

The current control function is the same use as the CLK-IN input control.

LV8746V

3-4) Typical current waveform in each excitation mode when stepping motor parallel input control
Full step (CW mode)

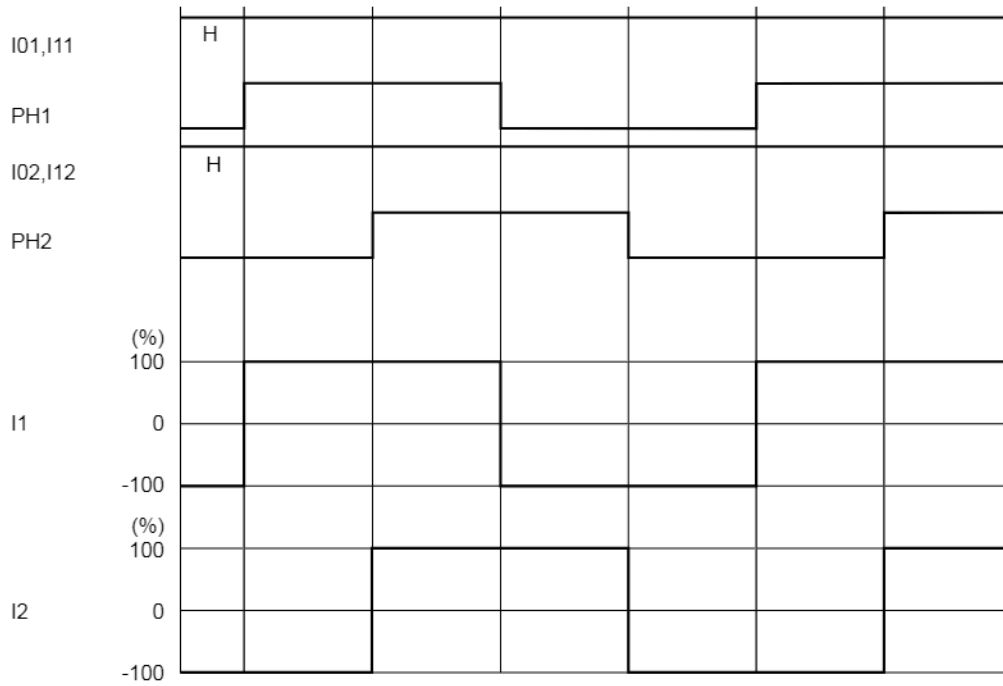

Half step full torque (CW mode)

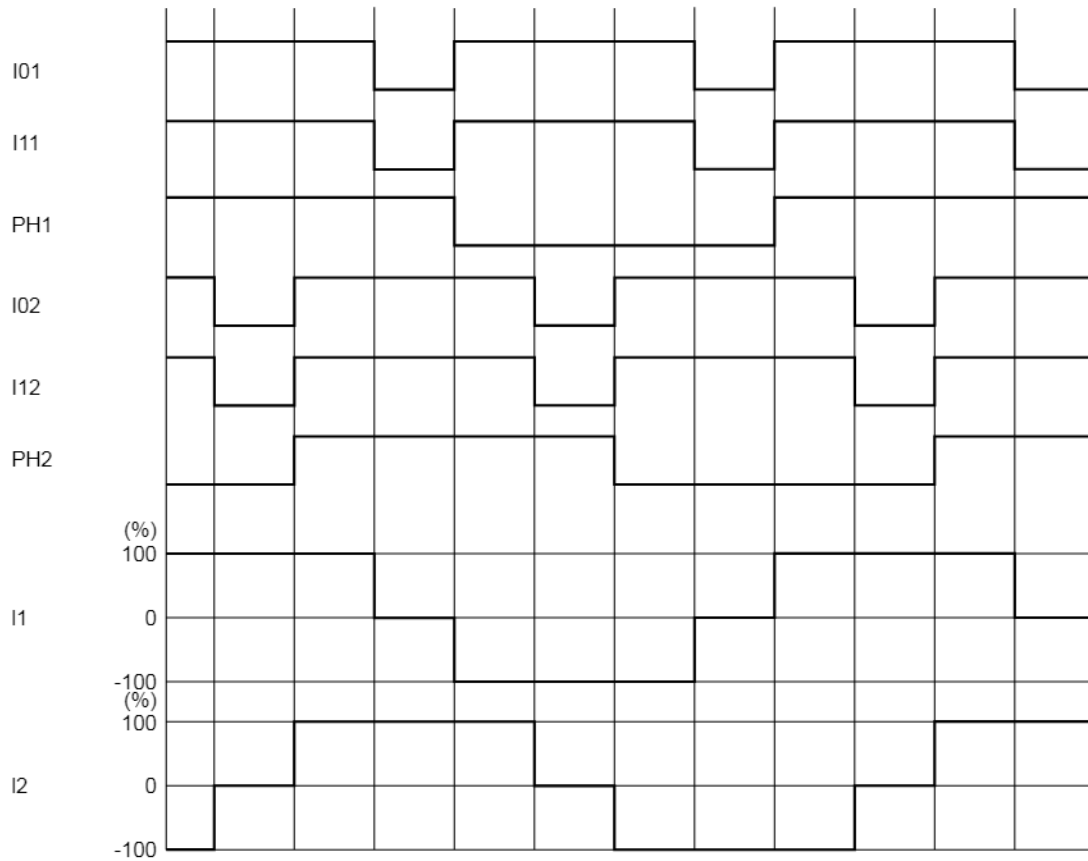

LV8746V

Half step (CW mode)

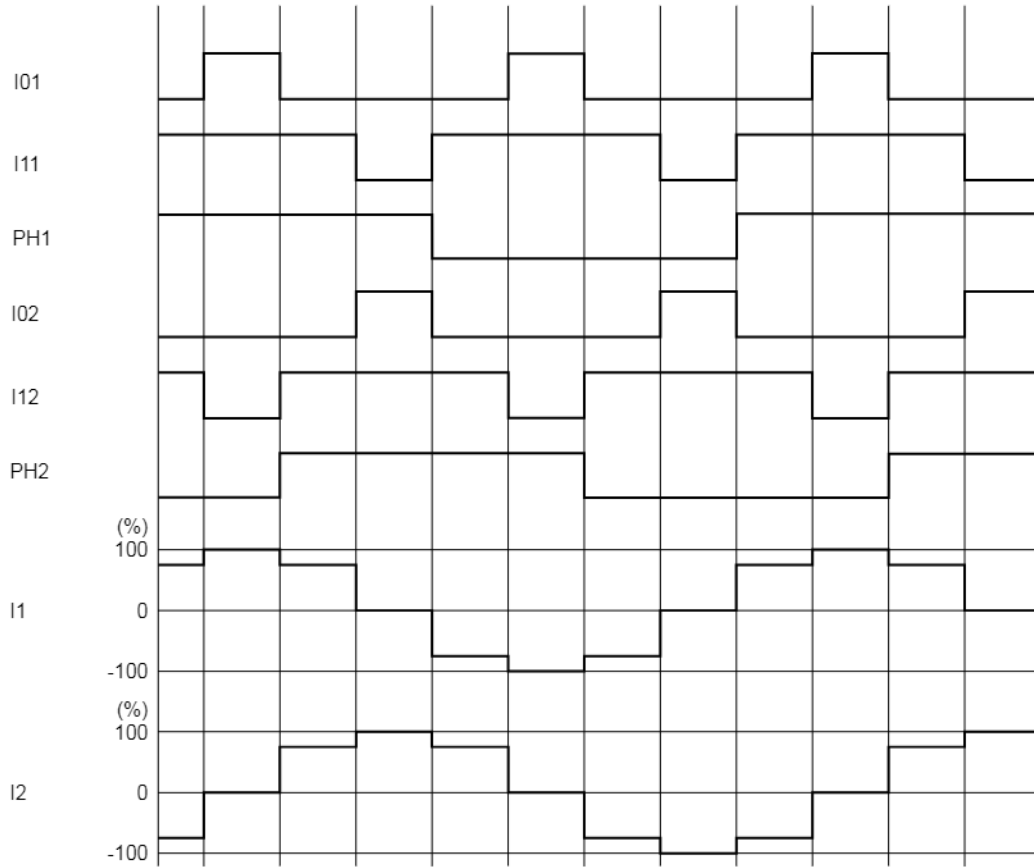

Quarter step (CW mode)

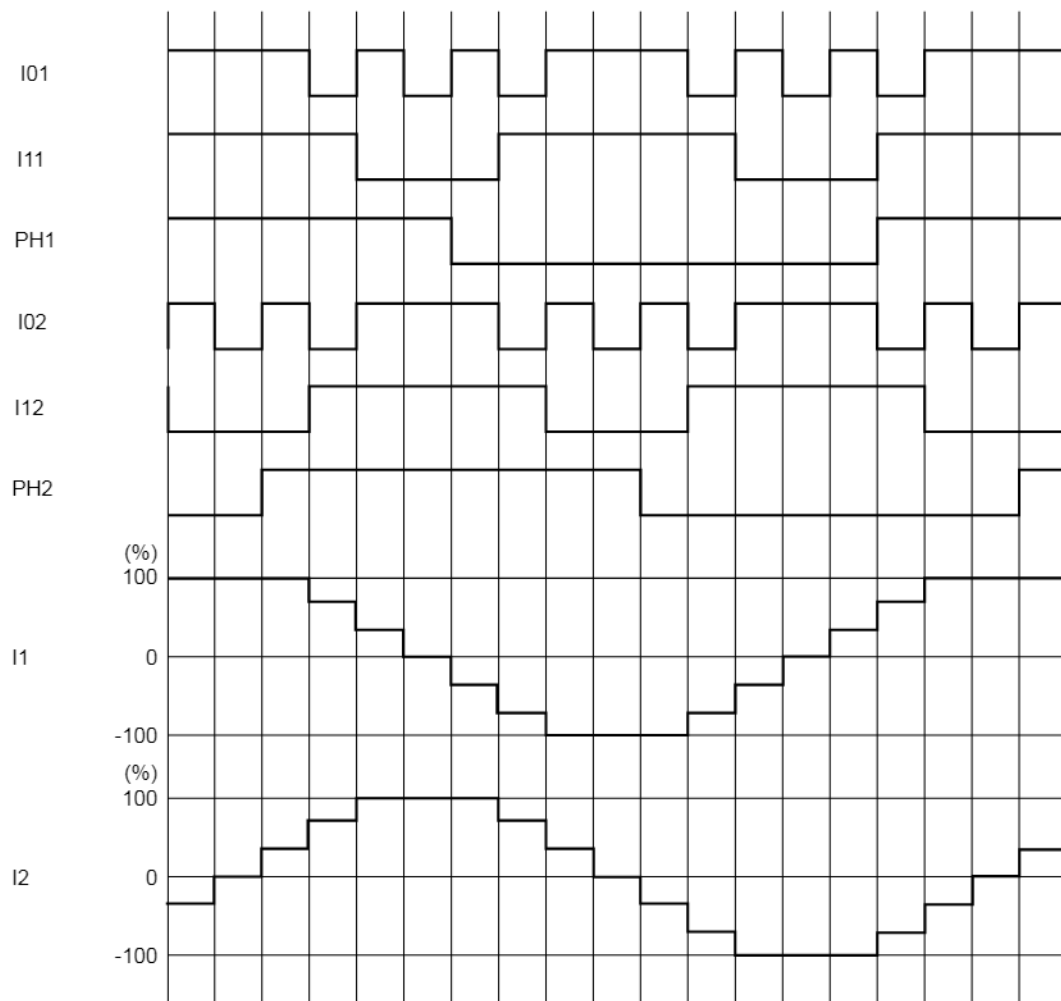

4. Output short-circuit protection function

This IC incorporates an output short-circuit protection circuit that, when the output has been shorted by an event such as shorting to power or shorting to ground, to prevent the thing that IC destroys, the output short-circuit protection circuit that turns off the output is built into.

4-1) Protection function operation(Latch type)

The detection of the output short-circuited state by the IC causes the output short-circuit protection circuit to be activated.

When the short-circuited state continues for the period of time set using the internal timer (1/4 of chopping cycle), the output in which the short-circuiting has been detected is first set to OFF. After this, the output is set to ON again as soon as the timer latch time (Tcem) described later has been exceeded, and if the short-circuited state is still detected, all the outputs of the channel concerned are switched to the standby mode, and this state is held.

This state is released by setting ST to low.

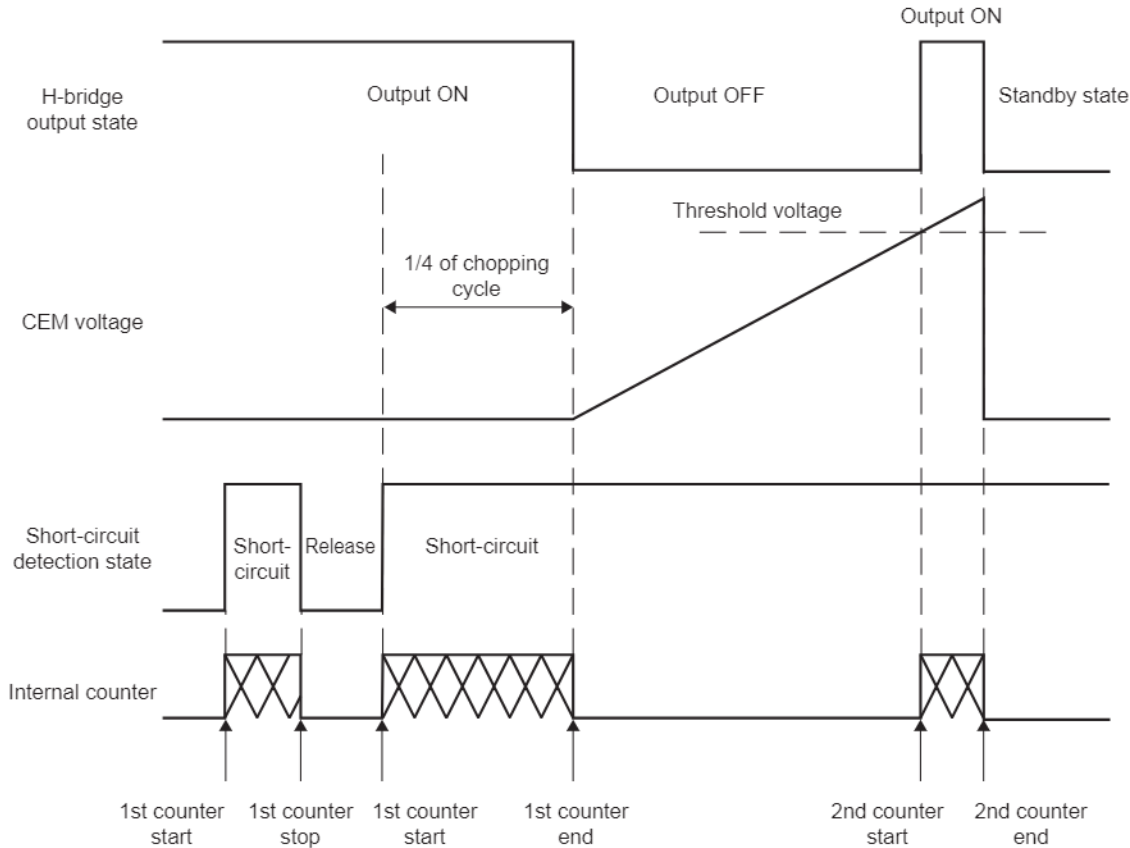

4-2) Unusual condition warning output pins (EMO)

IC is provided with the EMO pin which notifies the CPU of an unusual condition if the protection circuit operates by detecting an unusual condition of the IC. This pin is of the open-drain output type and when an unusual condition is detected, the EMO output is placed in the ON (EMO = Low) state.

Furthermore, the EMO pin is placed in the ON state when one of the following conditions occurs.

1. Shorting-to-power, shorting-to-ground, or shorting-to-load occurs at the output pin and the output short-circuit protection circuit is activated.
2. The IC junction temperature rises and the thermal protection circuit is activated.

4-3) Timer latch time (Tcem)

The time taken for the output to be set to OFF when the output has been short-circuited can be set using capacitor Ccem, connected between the CEM pin and GND. The value of capacitor Ccem is determined by the formula given below.

Timer latch : Tcem $Tcem \approx Ccem \times Vtcm / Icem$ [sec]
 Vtcm : Comparator threshold voltage, typ 1V
 Icem : CEM pin charge current, typ 10μA

5. Charge Pump Circuit

When the ST pin is set High, the charge pump circuit operates and the VG pin voltage is boosted from the VM voltage to the VM + VREG5 voltage. If the VG pin voltage is not boosted sufficiently, the output cannot be controlled, so be sure to provide a wait time of tONG or more after setting the ST pin High before starting to drive the motor.

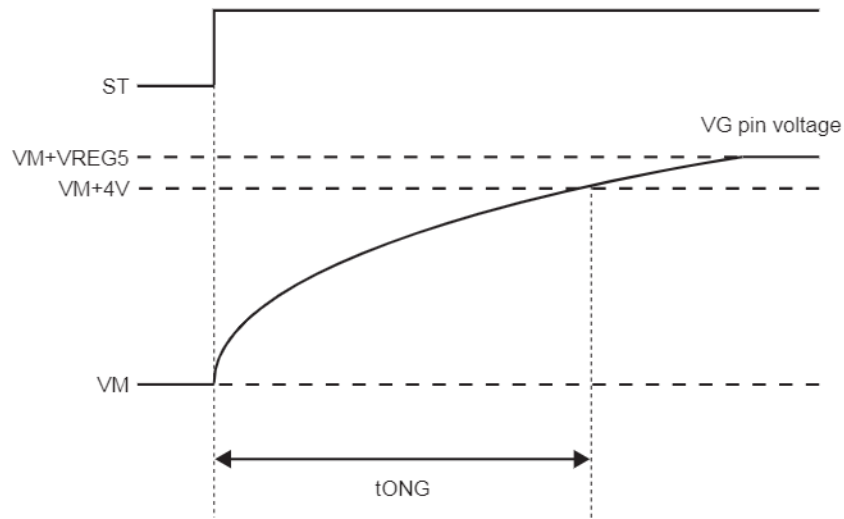

VG Pin Voltage Schematic View

6. Thermal shutdown function

The thermal shutdown circuit is included, and the output is turned off when junction temperature T_j exceeds $180\text{ }^\circ\text{C}$ and the abnormal state warning output is turned on at the same time.

When the temperature falls hysteresis level, output is driven again (automatic restoration)

The thermal shutdown circuit doesn't guarantee protection of the set and the destruction prevention of IC, because it works at the temperature that is higher than rating ($T_{jmax}=150\text{ }^\circ\text{C}$) of the junction temperature

TTSD = $180\text{ }^\circ\text{C}$ (typ)

Δ TSD = $40\text{ }^\circ\text{C}$ (typ)

LV8746V

Application Circuit Example

- Clock Inn mode application circuit

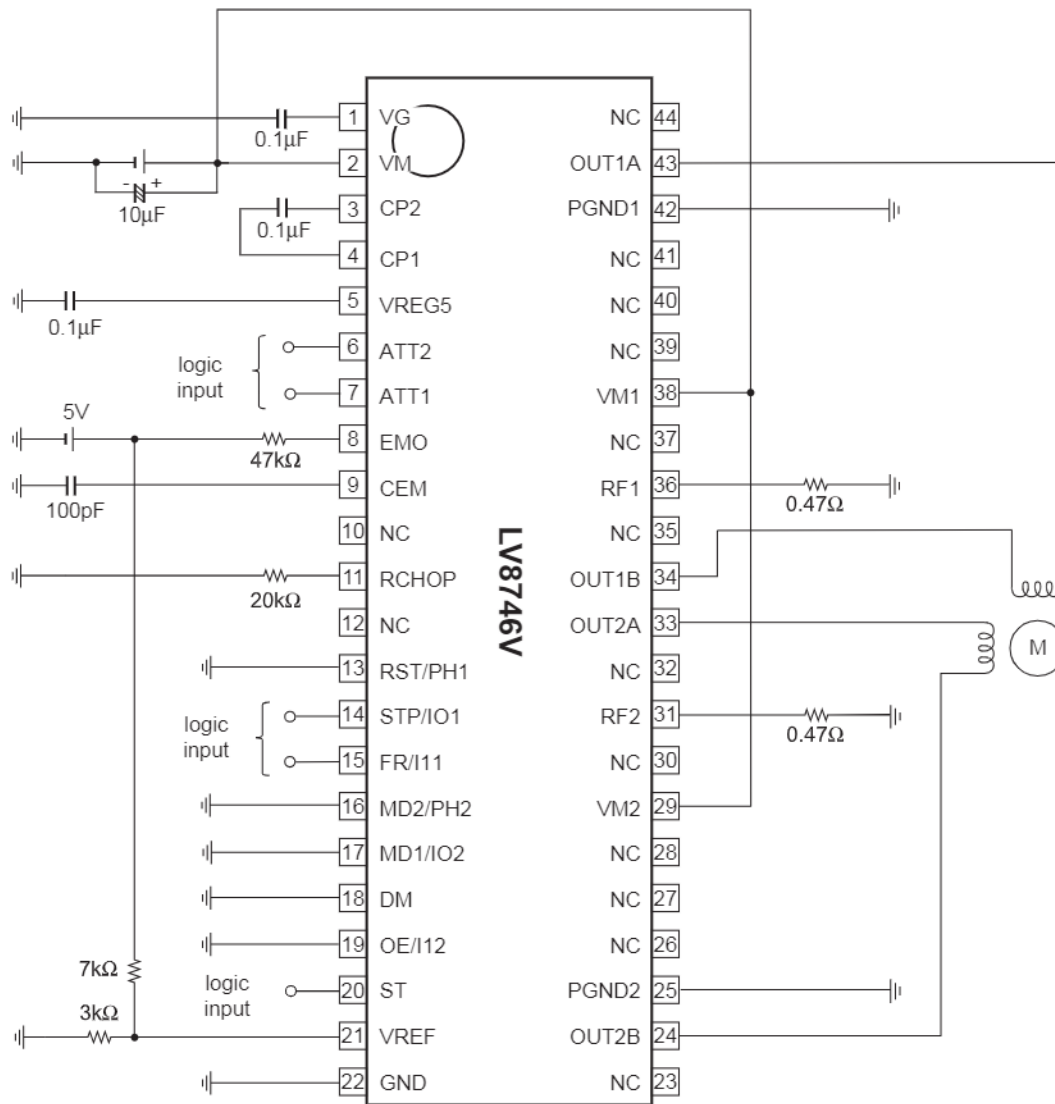

The setting conditions for the above circuit diagram example are as follows :

- 2-phase excitation (MD1/I02 = Low, MD2/PH2 = Low)
- Reset function fixed to normal operation (RST = Low)
- Chopping frequency : 62.5kHz (RCHOP = 20kΩ)

ATT1	ATT2	Current setting reference voltage
Low	Low	VREF/5×100%
High	Low	VREF/5×67%
Low	High	VREF/5×50%
High	High	VREF/5×33%

The set current value is as follows :

$$I_{OUT} = (VREF/5 \times \text{Voltage setting ratio}) / RF$$

Example) When ATT=Low,ATT2=Low (VREF = 1.5V,RF=0.47Ω)

$$I_{OUT} = (1.5V / 5 \times 1) / 0.47\Omega = 0.64A$$

LV8746V

- DC motor driver circuit (DM = High, and the current limit function is in use.)

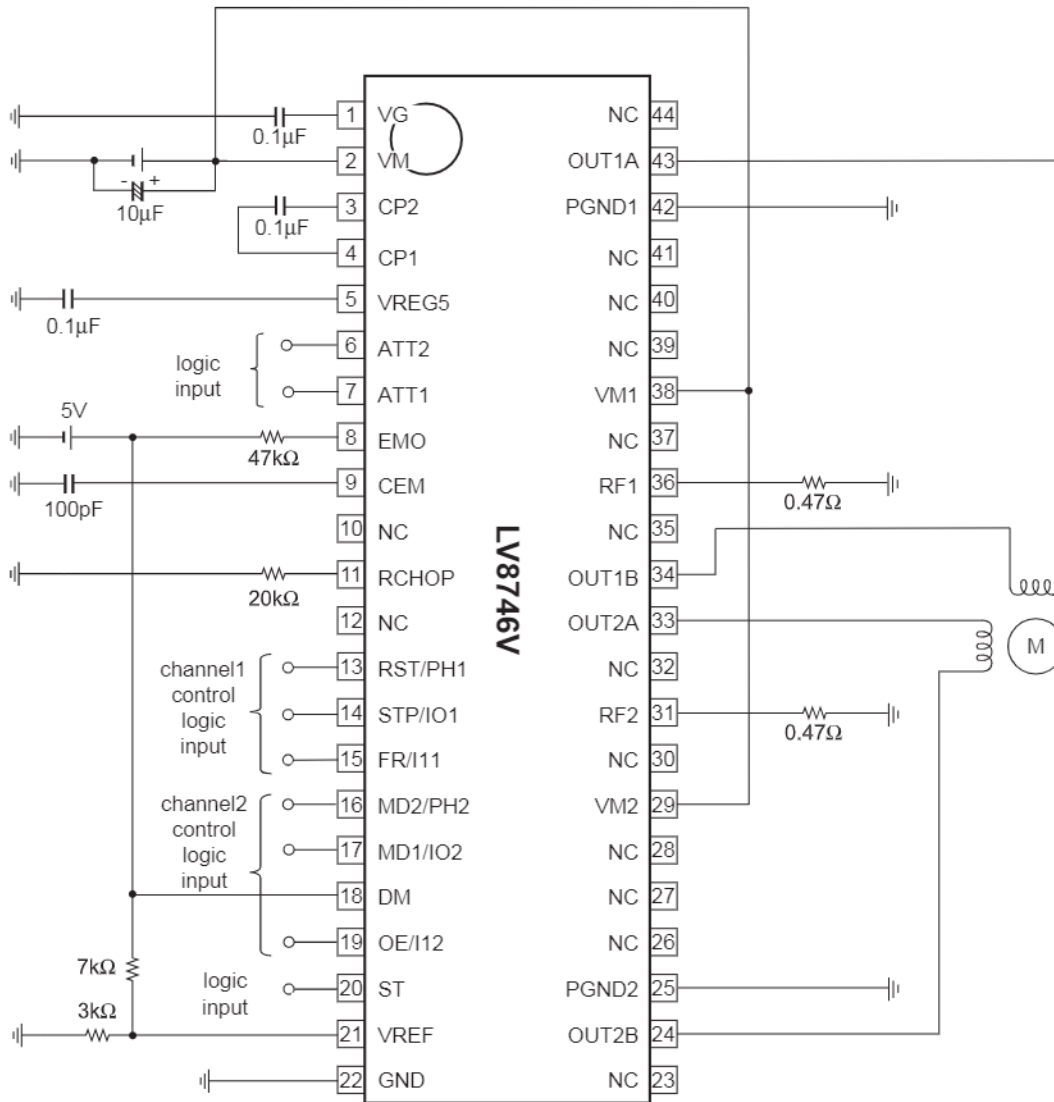

The setting conditions for the above circuit diagram example are as follows :

- Chopping frequency : 62.5kHz (RCHOP = 20kΩ)

I01(02)	I11(12)	Output current (I _O)
Low	Low	0
High	Low	$I_O = ((VREF/5) / RF) \times 1/3$
Low	High	$I_O = ((VREF/5) / RF) \times 2/3$
High	High	$I_O = (VREF/5) / RF$

Example) When ATT=Low,ATT2=Low,I01(02)=High,I11(12)=High (VREF = 1.5V,RF=0.47Ω)

$$I_{OUT} = (1.5V / 5 \times 1) / 0.47\Omega = 0.64A$$

PH1(2)	Electrical current direction
Low	OUTB → OUTA
High	OUTA → OUTB

LV8746V

ORDERING INFORMATION

Device	Package	Shipping (Qty / Packing)
LV8746V-TLM-E	SSOP44K (275mil) (Pb-Free)	2000 / Tape & Reel
LV8746V-MPB-E	SSOP44K (275mil) (Pb-Free)	30 / Fan-Fold

ON Semiconductor and the ON logo are registered trademarks of Semiconductor Components Industries, LLC (SCILLC). SCILLC owns the rights to a number of patents, trademarks, copyrights, trade secrets, and other intellectual property. A listing of SCILLC's product/patent coverage may be accessed at www.onsemi.com/site/pdf/Patent-Marking.pdf. SCILLC reserves the right to make changes without further notice to any products herein. SCILLC makes no warranty, representation or guarantee regarding the suitability of its products for any particular purpose, nor does SCILLC assume any liability arising out of the application or use of any product or circuit, and specifically disclaims any and all liability, including without limitation special, consequential or incidental damages. "Typical" parameters which may be provided in SCILLC data sheets and/or specifications can and do vary in different applications and actual performance may vary over time. All operating parameters, including "Typicals" must be validated for each customer application by customer's technical experts. SCILLC does not convey any license under its patent rights nor the rights of others. SCILLC products are not designed, intended, or authorized for use as components in systems intended for surgical implant into the body, or other applications intended to support or sustain life, or for any other application in which the failure of the SCILLC product could create a situation where personal injury or death may occur. Should Buyer purchase or use SCILLC products for any such unintended or unauthorized application, Buyer shall indemnify and hold SCILLC and its officers, employees, subsidiaries, affiliates, and distributors harmless against all claims, costs, damages, and expenses, and reasonable attorney fees arising out of, directly or indirectly, any claim of personal injury or death associated with such unintended or unauthorized use, even if such claim alleges that SCILLC was negligent regarding the design or manufacture of the part. SCILLC is an Equal Opportunity/Affirmative Action Employer. This literature is subject to all applicable copyright laws and is not for resale in any manner.