

NCP339

3 A Ultra-Small Controlled Load Switch with Auto-Discharge Path and Reverse Current Control

The NCP339 is a very low Ron MOSFET controlled by external logic pin, allowing optimization of battery life, and portable device autonomy.

Indeed, due to a current consumption optimization with PMOS structure, leakage currents are eliminated by isolating connected IC on the battery when not used.

Reverse blocking control is automatically engage if OUT pin voltage is higher than IN pin voltage, eliminate leakages current from OUT to IN.

Proposed in a wide input voltage range from 1.2 V to 5.5 V, in a small 1 x 1.5 mm WLCSP6, pitch 0.5 mm.

Features

- 1.2 V – 5.5 V Operating Range
- 19 mΩ P MOSFET at 4.5 V
- DC Current up to 3 A
- Soft Start Control
- Low Quiescent Current
- Reverse Blocking
- Active High EN pin
- WLCSP6 1 x 1.5 mm
- This is a Pb-Free Device

Typical Applications

- Mobile Phones
- Tablets
- Digital Cameras
- GPS
- Portable Devices
- Computers



ON Semiconductor®

<http://onsemi.com>



WLCSP6, 1.00x1.50
CASE 567FH

MARKING DIAGRAM

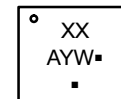

XX = NP or DP
A = Assembly Location
Y = Year
W = Work Week
▪ = Pb-Free Package

(*Note: Microdot may be in either location)

PACKAGE PINOUT DIAGRAM

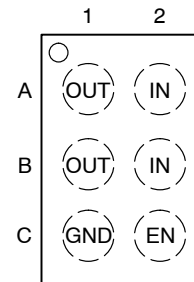

(Top View)

ORDERING INFORMATION

See detailed ordering, marking and shipping information in the package dimensions section on page 9 of this data sheet.

NCP339

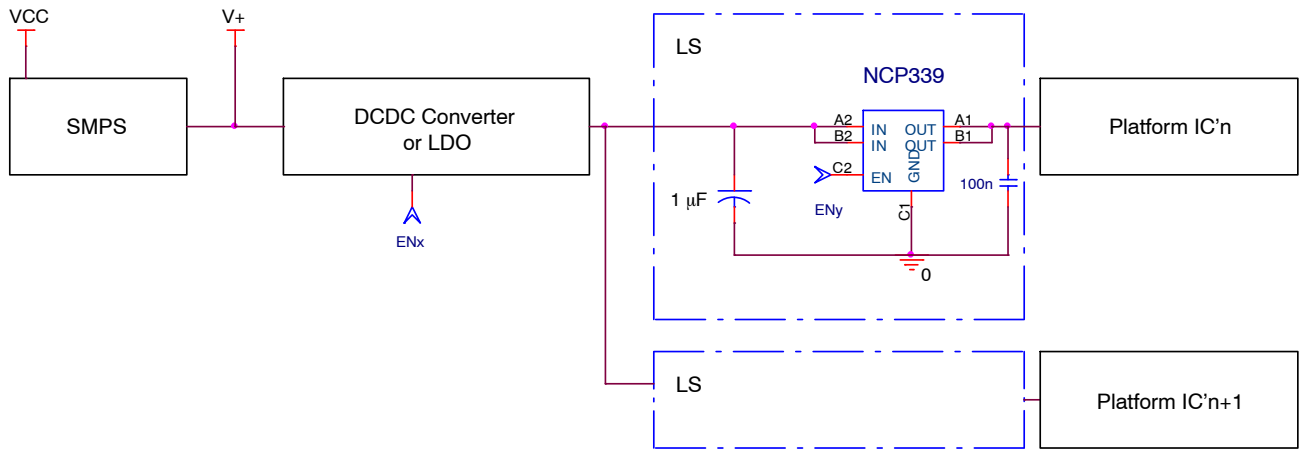

Figure 1. Typical Application Circuit

Table 1. PIN FUNCTION DESCRIPTION

Pin Name	Pin Number	Type	Description
IN	A2, B2	POWER	Load-switch input voltage; connect a 1 μ F or greater ceramic capacitor from IN to GND as close as possible to the IC.
GND	C1	POWER	Ground connection.
EN	C2	INPUT	Enable input, logic high turns on power switch.
OUT	A1, B1	OUTPUT	Load-switch output; connect a 100 nF ceramic capacitor from OUT to GND as close as possible to the IC is recommended.

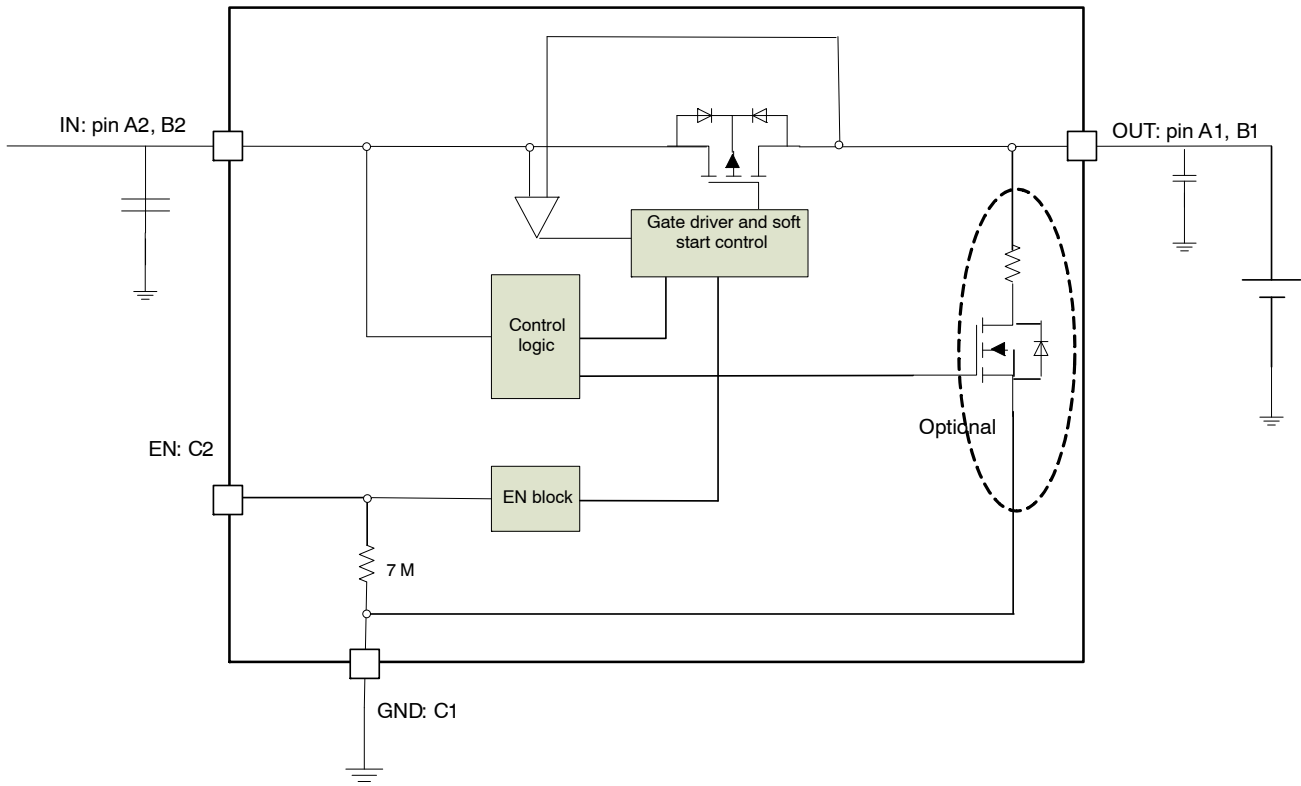

Figure 2. Block Diagram

NCP339

Table 2. MAXIMUM RATINGS

Rating	Symbol	Value	Unit
IN, OUT, EN, Pins: (Note 1)	V_{EN}, V_{IN}, V_{OUT}	-0.3 to +7.0	V
From IN to OUT Pins: Input/Output (Note 1)	V_{IN}, V_{OUT}	-7.0 to +7.0	V
Human Body Model (HBM) ESD Rating are (Note 1 and 2)	ESD HBM	4000	V
Machine Model (MM) ESD Rating are (Note 1 and 2)	ESD MM	250	V
Latch-up protection (Note 3) – Pins IN, OUT, EN	LU	100	mA
Maximum Junction Temperature	T_J	-40 to +125	°C
Storage Temperature Range	T_{STG}	-55 to +150	°C
Moisture Sensitivity (Note 4)	MSL	Level 1	

Stresses exceeding Maximum Ratings may damage the device. Maximum Ratings are stress ratings only. Functional operation above the Recommended Operating Conditions is not implied. Extended exposure to stresses above the Recommended Operating Conditions may affect device reliability.

Table 3. OPERATING CONDITIONS

Symbol	Parameter	Conditions	Min	Typ	Max	Unit
V_{IN}	Operational Power Supply		1.2		5.5	V
V_{EN}	Enable Voltage		0		5.5	
T_A	Ambient Temperature Range		-40	25	+85	°C
T_J	Junction Temperature Range		-40	25	+125	°C
C_{IN}	Decoupling input capacitor		1			μF
C_{OUT}	Decoupling output capacitor		100			nF
$R_{\theta JA}$	Thermal Resistance Junction to Air	WLCSP package (Note 3)		100		°C/W
I_{OUT}	Maximum DC current				3	A
P_D	Power Dissipation Rating (Note 4)	$T_A \leq 25\text{ °C}$	WLCSP package		1	W
		$T_A = 85\text{ °C}$	WLCSP package		0.4	W

1. According to JEDEC standard JESD22-A108.

2. Moisture Sensitivity Level (MSL): 1 per IPC/JEDEC standard: J-STD-020.

3. The $R_{\theta JA}$ is dependent of the PCB heat dissipation and thermal via.

4. The maximum power dissipation (P_D) is given by the following formula:

$$P_D = \frac{T_{JMAX} - T_A}{R_{\theta JA}}$$

NCP339

Table 4. ELECTRICAL CHARACTERISTICS

Min & Max Limits apply for T_A between -40°C to $+85^{\circ}\text{C}$ for V_{IN} between 1.2 V to 5.5 V (Unless otherwise noted).
Typical values are referenced to $T_A = +25^{\circ}\text{C}$ and $V_{IN} = 5\text{ V}$ (Unless otherwise noted).

Symbol	Parameter	Conditions		Min	Typ	Max	Unit
POWER SWITCH							
R_{DSON}	Static drain-source on-state resistance	$V_{\text{in}} = 5.5\text{ V}$	$I_{\text{out}} = 200\text{ mA}$, $T_A = 25^{\circ}\text{C}$		18		$\text{m}\Omega$
		$V_{\text{in}} = 5.5\text{ V}$	$T_J = 125^{\circ}\text{C}$			30	
		$V_{\text{in}} = 4.5\text{ V}$	$I_{\text{out}} = 200\text{ mA}$, $T_A = 25^{\circ}\text{C}$		19		
			$T_J = 125^{\circ}\text{C}$			30	
		$V_{\text{in}} = 3.3\text{ V}$	$I_{\text{out}} = 200\text{ mA}$, $T_A = 25^{\circ}\text{C}$		22		
			$T_J = 125^{\circ}\text{C}$			30	
		$V_{\text{in}} = 2.5\text{ V}$	$I_{\text{out}} = 200\text{ mA}$, $T_A = 25^{\circ}\text{C}$		27		
			$T_J = 125^{\circ}\text{C}$			40	
		$V_{\text{in}} = 1.8\text{ V}$	$I_{\text{out}} = 200\text{ mA}$, $T_A = 25^{\circ}\text{C}$		37		
			$T_J = 125^{\circ}\text{C}$			60	
	$V_{\text{in}} = 1.5\text{ V}$	$I_{\text{out}} = 200\text{ mA}$, $T_A = 25^{\circ}\text{C}$		48			
		$T_J = 125^{\circ}\text{C}$			110		
R_{dis}	Output discharge path	EN = low	Discharge path option		70	90	Ω
V_{IH}	High-level input voltage			1.2			V
V_{IL}	Low-level input voltage					0.8	
R_{pd}	EN pull down resistor			5.5	7.1	9.5	$\text{M}\Omega$

REVERSE CURRENT BLOCKING

$V_{\text{rev_thr}}$	Reverse threshold	$V_{\text{out}} - V_{\text{in}}$			40		mV
$V_{\text{rev_hyst}}$	Reverse threshold hysteresis				60		mV
T_{rev}	Reverse comparator response time	$V_{\text{out}} - V_{\text{in}} > V_{\text{rev_thr}}$			2.5		μs

QUIESCENT CURRENT

I_{std}	Standby current	$V_{\text{in}} = 4.2\text{ V}$	EN = low, No load, GND current		0.35	0.6	μA
$I_{\text{in_leak}}$	Mos leakage current	$V_{\text{in}} = 4.2\text{ V}$	EN = low, $V_{\text{out}} = \text{GND}$, V_{out} current		9	200	nA
I_{q}	Quiescent current	$V_{\text{in}} = 4.2\text{ V}$	EN = high, No load, GND current		1.0	1.5	μA
$I_{\text{out_leak}}$	Output leakage current	$V_{\text{out}} = 4.2\text{ V}$	$V_{\text{in}} = \text{GND}$		16	200	nA

TIMINGS

T_{EN}	Enable time	$V_{\text{in}} = 4.2\text{ V}$ (Note 6)	$R_L = 5\ \Omega$, $C_{\text{out}} = 100\ \mu\text{F}$		1.7		ms
T_{R}	Output rise time				2.7		
T_{ON}	ON time ($T_{\text{EN}} + T_{\text{R}}$)				4.4		
T_{F}	Output fall time				1.5		
T_{EN}	Enable time	$V_{\text{in}} = 4.2\text{ V}$ (Note 6)	$R_L = 25\ \Omega$, $C_{\text{out}} = 1\ \mu\text{F}$	0.5	1.0	2.5	ms
T_{R}	Output rise time			0.4	1.5	2.3	
T_{ON}	ON time ($T_{\text{EN}} + T_{\text{R}}$)			0.9	2.5	4.8	
T_{F}	Output fall time				0.06	0.1	

5. Guaranteed by design and characterization.

6. Parameters are guaranteed for C_{LOAD} and R_{LOAD} connected to the OUT pin with respect to the ground.

Table 4. ELECTRICAL CHARACTERISTICS

Min & Max Limits apply for T_A between -40°C to $+85^{\circ}\text{C}$ for V_{IN} between 1.2 V to 5.5 V (Unless otherwise noted).
 Typical values are referenced to $T_A = +25^{\circ}\text{C}$ and $V_{IN} = 5\text{ V}$ (Unless otherwise noted).

Symbol	Parameter	Conditions		Min	Typ	Max	Unit
T_{EN}	Enable time	$V_{in} = 4.2\text{ V}$ (Note 6)	$R_L = 150\ \Omega, C_{out} = 100\ \mu\text{F}$		1.7		ms
T_R	Output rise time				1.5		
T_{ON}	ON time ($T_{EN} + T_R$)				3.2		
T_{DIS}	Disable time				1.8		
T_F	Fall time				4		
T_{OFF}	Output fall time ($T_F + T_{DIS}$)				42		

- 5. Guaranteed by design and characterization.
- 6. Parameters are guaranteed for C_{LOAD} and R_{LOAD} connected to the OUT pin with respect to the ground.

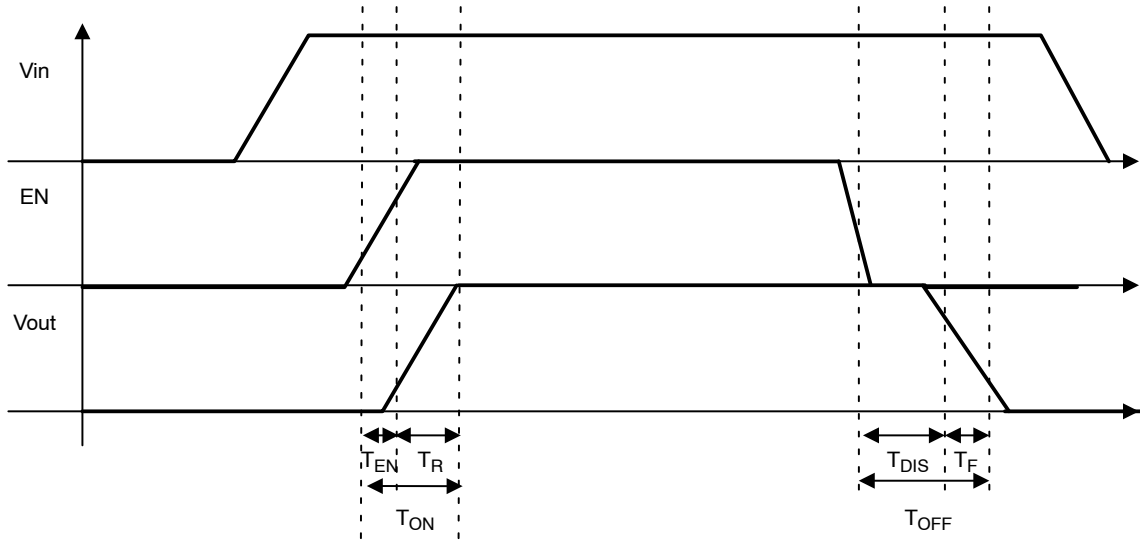

Figure 3. Timings

NCP339

TYPICAL CHARACTERISTICS

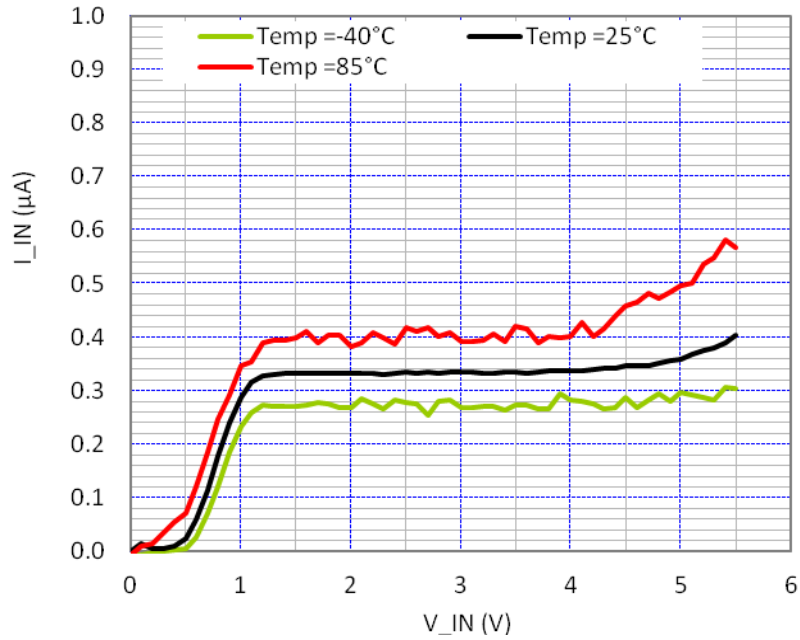

Figure 4. Standby Current (μA) versus V_{in} (V)

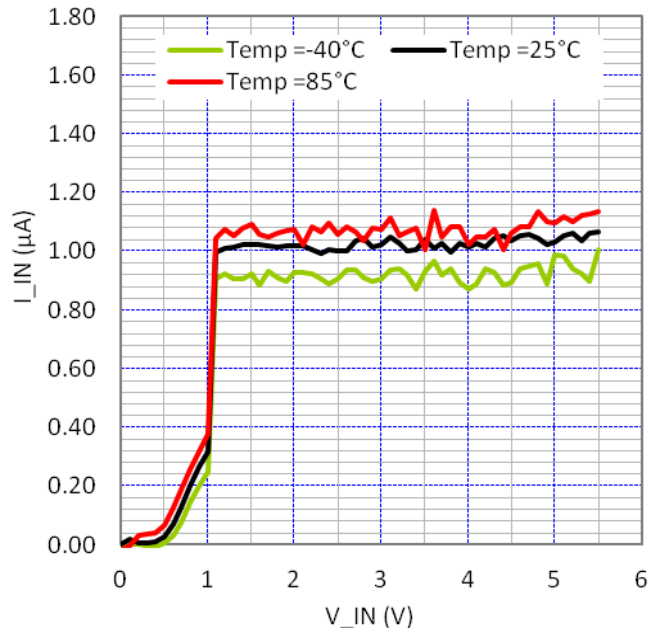

Figure 5. Quiescent Current (μA) versus V_{in} (V)

NCP339

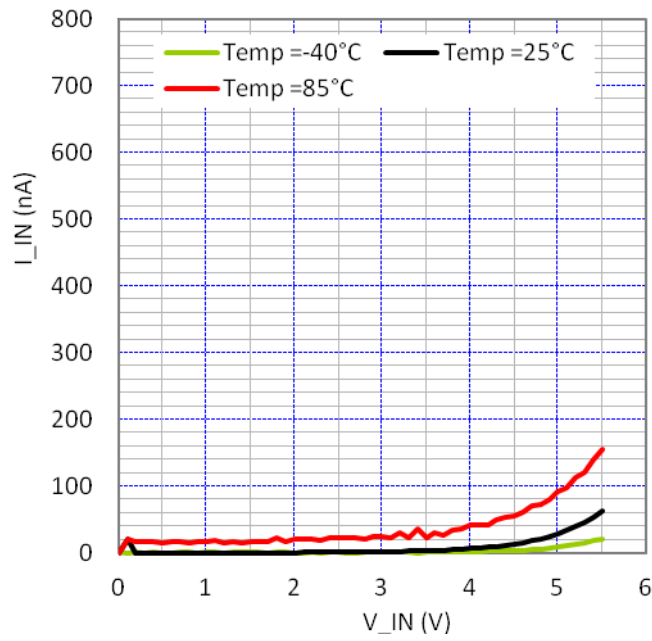

Figure 6. Reverse Current (nA) versus V_{in} (V)

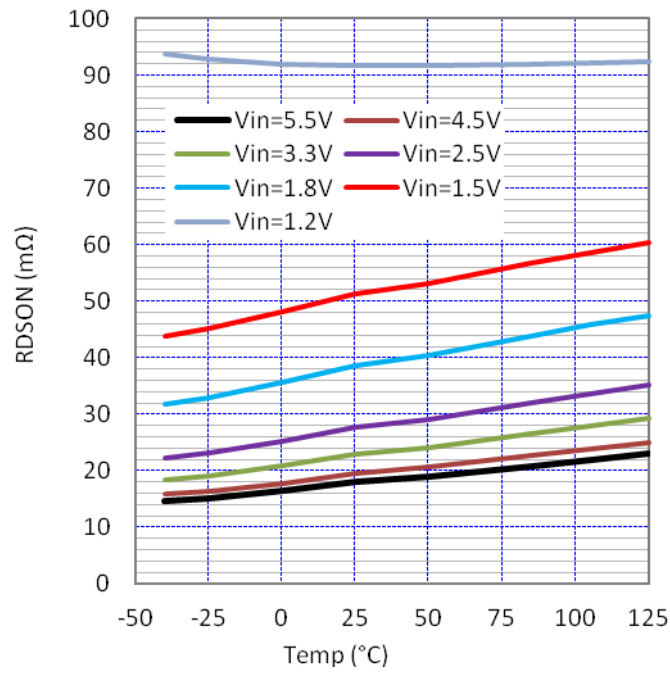

Figure 7. $R_{DS(on)}$ ($m\Omega$) versus Temperature ($I_{LOAD} = 100\text{ mA}$)

NCP339

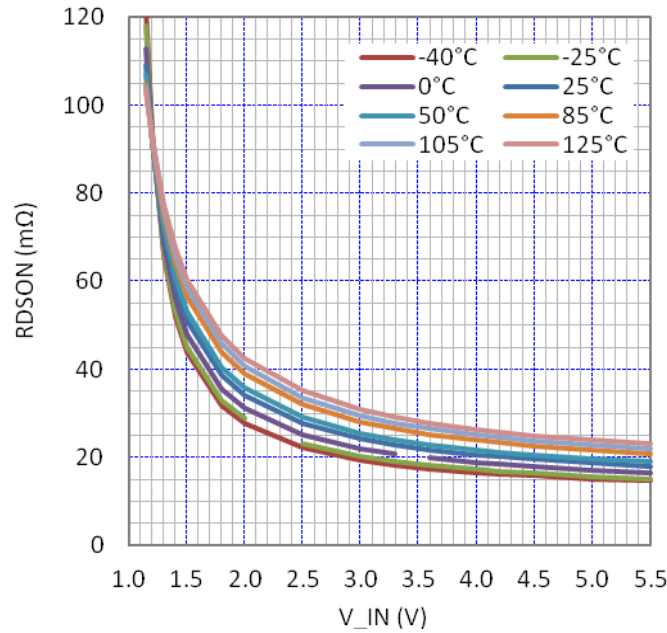

Figure 8. R_{DSON} (mΩ) versus V_{in} (V)

FUNCTIONAL DESCRIPTION

Overview

The NCP339 is a high side P channel MOSFET power distribution switch designed to isolate ICs connected on the battery in order to save energy. The part can be turned on, with a wide range of battery from 1.2 V to 5.5 V. Reverse blocking from output to input control is embedded in the IC to eliminate leakage current if V_{out} voltage exceed front end power supply.

Enable Input

Enable pin is an active high. The path is opened when EN pin is tied low (disable), forcing P MOS switch off.

The IN/OUT path is activated with a minimum of V_{in} of 1.2 V and EN forced to high level.

Blocking Control

The reverse blocking feature allows to avoid reverse current, through the PMOS fet if a voltage is applied on V_{out} pin, and V_{rev_thr} above the V_{in} pin. This function is available, whatever the EN logic pin state (High or low). To retrieve normal state, $V_{in}-V_{out}$ must be higher to hysteresis of the reverse blocking comparator (V_{rev_hyst}). The reverse blocking comparator response time is set to T_{rev} .

Table 5. CONTROL LOGIC

V_{IN}	V_{OUT}	EN
Present	Mos OFF	Low
Present	Mos ON	High
Mos OFF	$V_{OUT} > V_{IN}$	x

Auto Discharge (Optional)

NMOS FET is placed between the output pin and GND, in order to discharge the application capacitor connected on OUT pin.

The auto-discharge is activated when EN pin is set to low level (disable state).

The discharge path (Pull down NMOS) stays activated as long as EN pin is set at low level and $V_{in} > 1.2$ V.

In order to limit the current across the internal discharge Nmosfet, the typical value is set at 70 Ω.

Cin and Cout Capacitors

C_{in} 1 μF and C_{out} 100 nF , at least, capacitors must be placed as close as possible the part to for stability improvement.

For inrush effects at start up, it's recommended to respect $C_{in} > C_{out}$ size.

APPLICATION INFORMATION

Power Dissipation

Main contributor in term of junction temperature is the power dissipation of the power MOSFET. Assuming this, the power dissipation and the junction temperature in normal mode can be calculated with the following equations:

- $P_D = R_{DS(on)} \times (I_{OUT})^2$
 P_D = Power dissipation (W)
 $R_{DS(on)}$ = Power MOSFET on resistance (Ω)
 I_{OUT} = Output current (A)
- $T_J = P_D \times R_{\theta JA} + T_A$
 T_J = Junction temperature ($^{\circ}C$)
 $R_{\theta JA}$ = Package thermal resistance ($^{\circ}C/W$)
 T_A = Ambient temperature ($^{\circ}C$)

PCB Recommendations

The NCP339 integrates an up to 3 A rated PMOS FET, and the PCB design rules must be respected to properly evacuate the heat out of the silicon. By increasing PCB area, especially around IN and OUT pins, the $R_{\theta JA}$ of the package can be decreased, allowing higher power dissipation.

Routing example: 2 oz, 4 layers with vias across 2 internal inners.

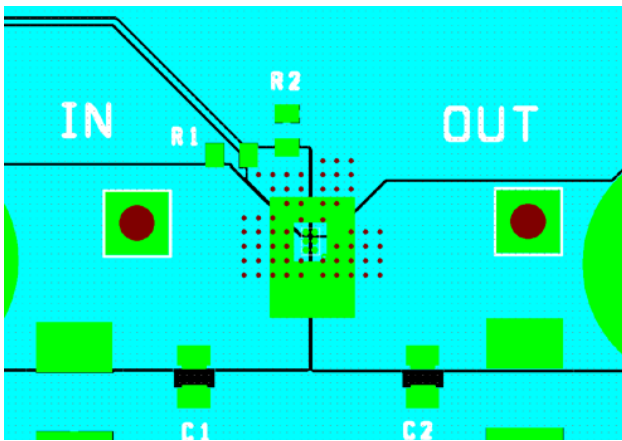

Figure 9.

Example of application definition.

$$T_J - T_A = R_{\theta JA} \times P_D = R_{\theta JA} \times R_{DS(on)} \times I^2$$

T_J : junction temperature.

T_A : ambient temperature.

R_{θ} = Thermal resistance between IC and air, through PCB.

$R_{DS(on)}$: intrinsic resistance of the IC Mosfet.

I : load DC current.

Taking into account of R_{θ} obtain with:

- 1 oz, 2 layers: $100^{\circ}C/W$.
 At 3 A, $25^{\circ}C$ ambient temperature, $R_{DS(on)}$ 20 m Ω @
 V_{in} 5 V, the junction temperature will be:
 $T_J = T_A + R_{\theta} \times P_D = 25 + (0.02 \times 3^2) \times 100 = 43^{\circ}C$

Taking into account of R_{θ} obtain with:

- 2 oz, 4 layers: $60^{\circ}C/W$.
 At 3 A, $65^{\circ}C$ ambient temperature, $R_{DS(on)}$ 24 m Ω @
 V_{in} 5 V, the junction temperature will be:
 $T_J = T_A + R_{\theta} \times P_D = 65 + (0.024 \times 3^2) \times 60 = 78^{\circ}C$

ORDERING INFORMATION

Device	Marking	Option	Package	Shipping†
NCP339AFCT2G	NP	Without Auto-discharge	WLCSP6, 1 x 1.5 mm (Pb-Free)	3000 / Tape & Reel
NCP339BFCT2G	DP	With Auto-discharge	WLCSP6, 1 x 1.5 mm (Pb-Free)	3000 / Tape & Reel

†For information on tape and reel specifications, including part orientation and tape sizes, please refer to our Tape and Reel Packaging Specifications Brochure, BRD8011/D.

MECHANICAL CASE OUTLINE PACKAGE DIMENSIONS

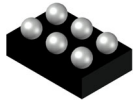

WLCSP6 1.0x1.5x0.609
CASE 567FH
ISSUE A

DATE 21 JUN 2022

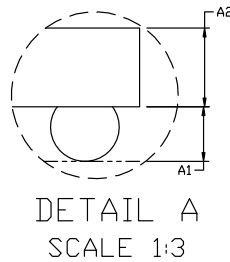
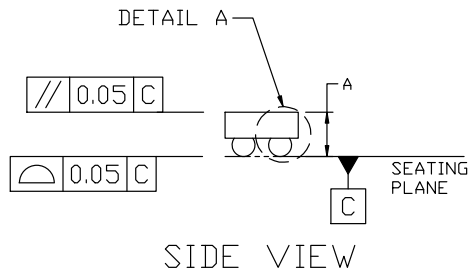
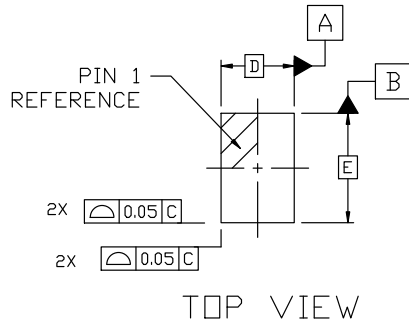

NOTES:

1. DIMENSIONING AND TOLERANCING PER ASME Y14.5M, 1994.
2. CONTROLLING DIMENSION: MILLIMETERS
3. COPLANARITY APPLIES TO THE SPHERICAL CROWNS OF THE SOLDER BALLS.

DIM	MILLIMETERS		
	MIN.	NOM.	MAX.
A	0.554	0.609	0.664
A1	0.219	0.249	0.279
A2	0.335	0.360	0.385
b	0.282	0.312	0.342
D	1.00 BSC		
E	1.50 BSC		
e	0.50 BSC		

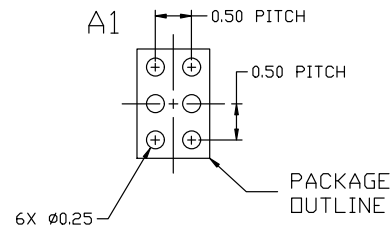
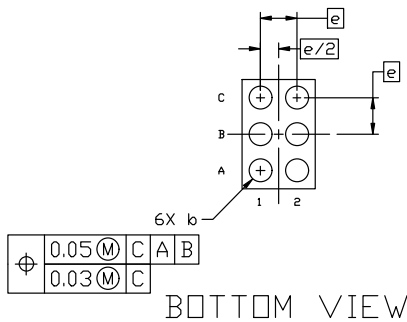

RECOMMENDED
MOUNTING FOOTPRINT*

* For additional information on our Pb-Free strategy and soldering details, please download the ON Semiconductor Soldering and Mounting Techniques Reference Manual, SOLDERRM/D.

**GENERIC
MARKING DIAGRAM***

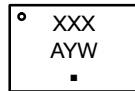

XXX = Specific Device Code
A = Assembly Location
Y = Year
W = Work Week
▪ = Pb-Free Package

*This information is generic. Please refer to device data sheet for actual part marking. Pb-Free indicator, "G" or microdot "▪", may or may not be present. Some products may not follow the Generic Marking.

DOCUMENT NUMBER:	98AON79918E	Electronic versions are uncontrolled except when accessed directly from the Document Repository. Printed versions are uncontrolled except when stamped "CONTROLLED COPY" in red.
DESCRIPTION:	WLCSP6 1.0x1.5x0.609	PAGE 1 OF 1

onsemi and ONSEMI are trademarks of Semiconductor Components Industries, LLC dba onsemi or its subsidiaries in the United States and/or other countries. onsemi reserves the right to make changes without further notice to any products herein. onsemi makes no warranty, representation or guarantee regarding the suitability of its products for any particular purpose, nor does onsemi assume any liability arising out of the application or use of any product or circuit, and specifically disclaims any and all liability, including without limitation special, consequential or incidental damages. onsemi does not convey any license under its patent rights nor the rights of others.

onsemi, **Onsemi**, and other names, marks, and brands are registered and/or common law trademarks of Semiconductor Components Industries, LLC dba "**onsemi**" or its affiliates and/or subsidiaries in the United States and/or other countries. **onsemi** owns the rights to a number of patents, trademarks, copyrights, trade secrets, and other intellectual property. A listing of **onsemi**'s product/patent coverage may be accessed at www.onsemi.com/site/pdf/Patent-Marking.pdf. **onsemi** reserves the right to make changes at any time to any products or information herein, without notice. The information herein is provided "as-is" and **onsemi** makes no warranty, representation or guarantee regarding the accuracy of the information, product features, availability, functionality, or suitability of its products for any particular purpose, nor does **onsemi** assume any liability arising out of the application or use of any product or circuit, and specifically disclaims any and all liability, including without limitation special, consequential or incidental damages. Buyer is responsible for its products and applications using **onsemi** products, including compliance with all laws, regulations and safety requirements or standards, regardless of any support or applications information provided by **onsemi**. "Typical" parameters which may be provided in **onsemi** data sheets and/or specifications can and do vary in different applications and actual performance may vary over time. All operating parameters, including "Typicals" must be validated for each customer application by customer's technical experts. **onsemi** does not convey any license under any of its intellectual property rights nor the rights of others. **onsemi** products are not designed, intended, or authorized for use as a critical component in life support systems or any FDA Class 3 medical devices or medical devices with a same or similar classification in a foreign jurisdiction or any devices intended for implantation in the human body. Should Buyer purchase or use **onsemi** products for any such unintended or unauthorized application, Buyer shall indemnify and hold **onsemi** and its officers, employees, subsidiaries, affiliates, and distributors harmless against all claims, costs, damages, and expenses, and reasonable attorney fees arising out of, directly or indirectly, any claim of personal injury or death associated with such unintended or unauthorized use, even if such claim alleges that **onsemi** was negligent regarding the design or manufacture of the part. **onsemi** is an Equal Opportunity/Affirmative Action Employer. This literature is subject to all applicable copyright laws and is not for resale in any manner.

PUBLICATION ORDERING INFORMATION

LITERATURE FULFILLMENT:

Email Requests to: orderlit@onsemi.com

onsemi Website: www.onsemi.com

TECHNICAL SUPPORT

North American Technical Support:

Voice Mail: 1 800-282-9855 Toll Free USA/Canada

Phone: 011 421 33 790 2910

Europe, Middle East and Africa Technical Support:

Phone: 00421 33 790 2910

For additional information, please contact your local Sales Representative