

# NLU1GT125

## Non-Inverting 3-State Buffer, TTL Level LSTTL-Compatible Inputs

The NLU1GT125 MiniGate™ is an advanced CMOS high-speed non-inverting buffer in ultra-small footprint.

The NLU1GT125 requires the 3-state control input  $\overline{OE}$  to be set High to place the output in the high impedance state.

The device input is compatible with TTL-type input thresholds and the output has a full 5.0 V CMOS level output swing.

The NLU1GT125 input and output structures provide protection when voltages up to 7.0 V are applied, regardless of the supply voltage.

### Features

- High Speed:  $t_{PD} = 3.8 \text{ ns (Typ) @ } V_{CC} = 5.0 \text{ V}$
- Low Power Dissipation:  $I_{CC} = 1 \mu\text{A (Max) at } T_A = 25^\circ\text{C}$
- TTL-Compatible Input:  $V_{IL} = 0.8 \text{ V; } V_{IH} = 2.0 \text{ V}$
- CMOS-Compatible Output:  
 $V_{OH} > 0.8 V_{CC}; V_{OL} < 0.1 V_{CC} @ \text{Load}$
- Power Down Protection Provided on inputs
- Balanced Propagation Delays
- Ultra-Small Packages
- NLV Prefix for Automotive and Other Applications Requiring Unique Site and Control Change Requirements; AEC-Q100 Qualified and PPAP Capable
- These are Pb-Free Devices

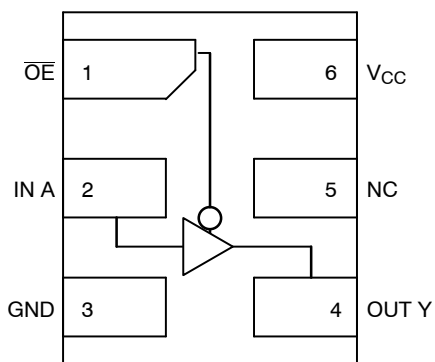

Figure 1. Pinout (Top View)



Figure 2. Logic Symbol

### FUNCTION TABLE

Input		Output
A	$\overline{OE}$	Y
L	L	L
H	L	H
X	H	Z

### PIN ASSIGNMENT

1	$\overline{OE}$
2	IN A
3	GND
4	OUT Y
5	NC
6	$V_{CC}$



ON Semiconductor®

[www.onsemi.com](http://www.onsemi.com)

### MARKING DIAGRAMS

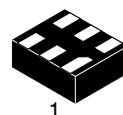

UDFN6  
1.2 x 1.0  
CASE 517AA



UDFN6  
1.0 x 1.0  
CASE 517BX

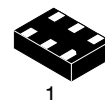

UDFN6  
1.45 x 1.0  
CASE 517AQ



7 = Device Marking  
M = Date Code

### ORDERING INFORMATION

See detailed ordering and shipping information on page 4 of this data sheet.

# NLU1GT125

## MAXIMUM RATINGS

Symbol	Parameter	Value	Unit
$V_{CC}$	DC Supply Voltage	-0.5 to +7.0	V
$V_{IN}$	DC Input Voltage	-0.5 to +7.0	V
$V_{OUT}$	DC Output Voltage	-0.5 to +7.0	V
$I_{IK}$	DC Input Diode Current $V_{IN} < GND$	-20	mA
$I_{OK}$	DC Output Diode Current $V_{OUT} < GND$	±20	mA
$I_O$	DC Output Source/Sink Current	±12.5	mA
$I_{CC}$	DC Supply Current Per Supply Pin	±25	mA
$I_{GND}$	DC Ground Current per Ground Pin	±25	mA
$T_{STG}$	Storage Temperature Range	-65 to +150	°C
$T_L$	Lead Temperature, 1 mm from Case for 10 Seconds	260	°C
$T_J$	Junction Temperature Under Bias	150	°C
MSL	Moisture Sensitivity	Level 1	
$F_R$	Flammability Rating Oxygen Index: 28 to 34	UL 94 V-0 @ 0.125 in	
$I_{LATCHUP}$	Latchup Performance Above $V_{CC}$ and Below GND at 125°C (Note 2)	±500	mA

Stresses exceeding those listed in the Maximum Ratings table may damage the device. If any of these limits are exceeded, device functionality should not be assumed, damage may occur and reliability may be affected.

1. Measured with minimum pad spacing on an FR4 board, using 10 mm-by-1 inch, 2 ounce copper trace no air flow.
2. Tested to EIA / JESD78.

## RECOMMENDED OPERATING CONDITIONS

Symbol	Parameter	Min	Max	Unit
$V_{CC}$	Positive DC Supply Voltage	1.65	5.5	V
$V_{IN}$	Digital Input Voltage	0	5.5	V
$V_{OUT}$	Output Voltage	0	5.5	V
$T_A$	Operating Free-Air Temperature	-55	+125	°C
$\Delta t/\Delta V$	Input Transition Rise or Fall Rate $V_{CC} = 3.3 V \pm 0.3 V$ $V_{CC} = 5.0 V \pm 0.5 V$	0 0	100 20	ns/V

# NLU1GT125

## DC ELECTRICAL CHARACTERISTICS

Symbol	Parameter	Conditions	V <sub>CC</sub> (V)	T <sub>A</sub> = 25 °C			T <sub>A</sub> = +85°C		T <sub>A</sub> = -55°C to +125°C		Unit
				Min	Typ	Max	Min	Max	Min	Max	
V <sub>IH</sub>	Low-Level Input Voltage		3.0 4.5 to 5.5	1.4 2.0			1.4 2.0		1.4 2.0		V
V <sub>IL</sub>	Low-Level Input Voltage		3.0 4.5 to 5.5			0.53 0.8		0.53 0.8		0.53 0.8	V
V <sub>OH</sub>	High-Level Output Voltage	V <sub>IN</sub> = V <sub>IH</sub> or V <sub>IL</sub> I <sub>OH</sub> = -50 μA	3.0 4.5	2.9 4.4	3.0 4.5		2.9 4.4		2.9 4.4		V
		V <sub>IN</sub> = V <sub>IH</sub> or V <sub>IL</sub> I <sub>OH</sub> = -4 mA I <sub>OH</sub> = -8 mA	3.0 4.5	2.58 3.94			2.48 3.80		2.34 3.66		
V <sub>OL</sub>	Low-Level Output Voltage	V <sub>IN</sub> = V <sub>IH</sub> or V <sub>IL</sub> I <sub>OL</sub> = 50 μA	3.0 4.5		0 0	0.1 0.1		0.1 0.1		0.1 0.1	V
		V <sub>IN</sub> = V <sub>IH</sub> or V <sub>IL</sub> I <sub>OL</sub> = 4 mA I <sub>OL</sub> = 8 mA	3.0 4.5			0.36 0.36		0.44 0.44		0.52 0.52	
I <sub>IN</sub>	Input Leakage Current	0 ≤ V <sub>IN</sub> ≤ 5.5 V	0 to 5.5			±0.1		±1.0		±1.0	μA
I <sub>CC</sub>	Quiescent Supply Current	0 ≤ V <sub>IN</sub> ≤ V <sub>CC</sub>	5.5			1.0		20		40	μA
I <sub>CC(T)</sub>	Quiescent Supply Current	V <sub>IN</sub> = 3.4 V Other Input: V <sub>CC</sub> or GND	5.5			1.35		1.50		1.65	mA
I <sub>OPD</sub>	Output Leakage Current	V <sub>OUT</sub> = 5.5 V	0.0			0.5		5.0		10	μA
I <sub>OZ</sub>	3-State Leakage Current	V <sub>IN</sub> = V <sub>IH</sub> or V <sub>IL</sub> V <sub>OUT</sub> = V <sub>CC</sub> or GND	0.0			±0.25		±2.5		±2.5	μA

## AC ELECTRICAL CHARACTERISTICS (Input t<sub>r</sub> = t<sub>f</sub> = 3.0 ns)

Symbol	Parameter	V <sub>CC</sub> (V)	Test Condition	T <sub>A</sub> = 25 °C			T <sub>A</sub> = +85°C		T <sub>A</sub> = -55°C to +125°C		Unit
				Min	Typ	Max	Min	Max	Min	Max	
t <sub>PLH</sub> , t <sub>PHL</sub>	Propagation Delay, A to Y (Figures 3 and 5)	3.0 to 3.6	C <sub>L</sub> = 15 pF C <sub>L</sub> = 50 pF		5.6 8.1	8.0 11.5	1.0 1.0	9.5 13.0		12.0 16.0	ns
		4.5 to 5.5	C <sub>L</sub> = 15 pF C <sub>L</sub> = 50 pF		3.8 5.3	5.5 7.5	1.0 1.0	6.5 8.5		8.5 10.5	
t <sub>PZL</sub> , t <sub>PZH</sub>	Output Enable Time, $\overline{OE}$ to Y (Figures 4 and 6)	3.0 to 3.6	C <sub>L</sub> = 15 pF C <sub>L</sub> = 50 pF		5.4 7.9	8.0 11.5	1.0 1.0	9.5 13.0		11.5 15.0	ns
		4.5 to 5.5	C <sub>L</sub> = 15 pF C <sub>L</sub> = 50 pF		3.6 5.1	5.1 7.1	1.0 1.0	6.0 8.0		7.5 9.5	
t <sub>PLZ</sub> , t <sub>PHZ</sub>	Output Disable Time, $\overline{OE}$ to Y (Figures 4 and 6)	3.0 to 3.6	C <sub>L</sub> = 15 pF C <sub>L</sub> = 50 pF		6.5 8.0	9.7 13.2	1.0 1.0	11.5 15.0		14.5 18.5	ns
		4.5 to 5.5	C <sub>L</sub> = 15 pF C <sub>L</sub> = 50 pF		4.8 7.0	6.8 8.8	1.0 1.0	8.0 10.0		10.0 12.0	
C <sub>IN</sub>	Input Capacitance				4	10		10		10.0	pF
C <sub>OUT</sub>	3-State Output Capacitance (Output in High Impedance State)				6						pF
C <sub>PD</sub>	Power Dissipation Capacitance (Note 3)	5.0			14						pF

3. C<sub>PD</sub> is defined as the value of the internal equivalent capacitance which is calculated from the dynamic operating current consumption without load. Average operating current can be obtained by the equation I<sub>CC(OPR)</sub> = C<sub>PD</sub> • V<sub>CC</sub> • f<sub>in</sub> + I<sub>CC</sub>. C<sub>PD</sub> is used to determine the no-load dynamic power consumption: P<sub>D</sub> = C<sub>PD</sub> • V<sub>CC</sub><sup>2</sup> • f<sub>in</sub> + I<sub>CC</sub> • V<sub>CC</sub>.

# NLU1GT125

## SWITCHING WAVEFORMS

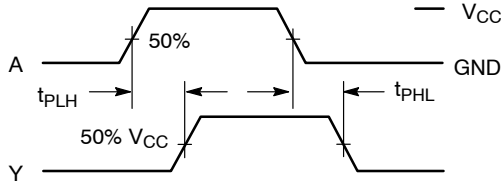

Figure 3. Switching Waveforms

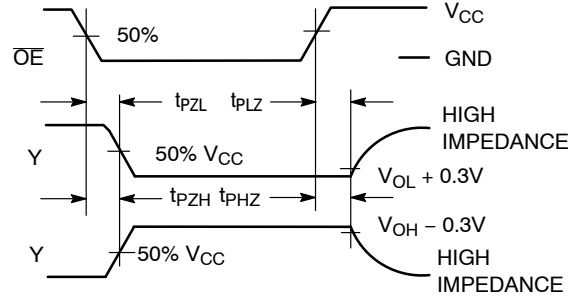

Figure 4.

MiniGate is a trademark of Semiconductor Components Industries, LLC (SCILLC).

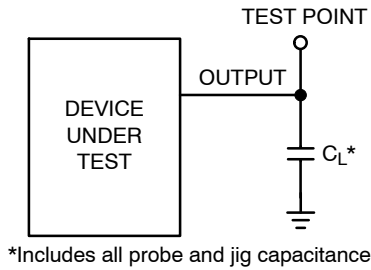

Figure 5. Test Circuit

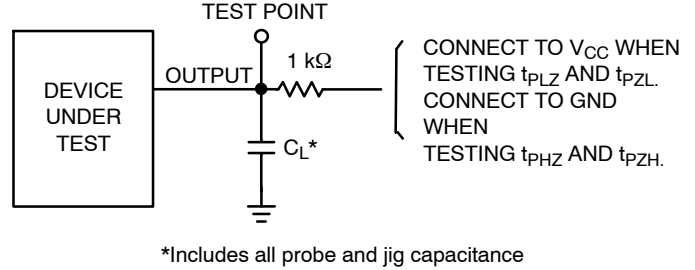

Figure 6. Test Circuit

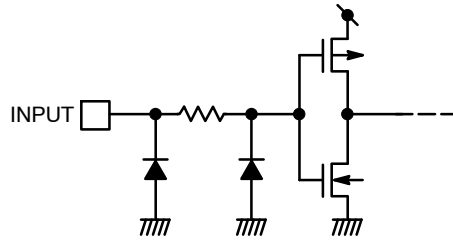

Figure 7. Input Equivalent Circuit

## ORDERING INFORMATION

Device	Package	Shipping†
NLU1GT125MUTCG	UDFN6, 1.2 x 1.0, 0.4P (Pb-Free)	3000 / Tape & Reel
NLU1GT125AMUTCG, NLVU1GT125AMUTCG*	UDFN6, 1.45 x 1.0, 0.5P (Pb-Free)	3000 / Tape & Reel
NLU1GT125CMUTCG	UDFN6, 1.0 x 1.0, 0.35P (Pb-Free)	3000 / Tape & Reel

†For information on tape and reel specifications, including part orientation and tape sizes, please refer to our Tape and Reel Packaging Specifications Brochure, BRD8011/D.

\*NLV Prefix for Automotive and Other Applications Requiring Unique Site and Control Change Requirements; AEC-Q100 Qualified and PPAP Capable.

# MECHANICAL CASE OUTLINE PACKAGE DIMENSIONS



SCALE 4:1

UDFN6, 1.45x1.0, 0.5P  
CASE 517AQ  
ISSUE O

DATE 15 MAY 2008

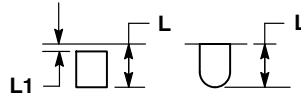

**DETAIL A**  
OPTIONAL  
CONSTRUCTIONS

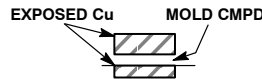

**DETAIL B**  
OPTIONAL  
CONSTRUCTIONS

**NOTES:**

1. DIMENSIONING AND TOLERANCING PER ASME Y14.5M, 1994.
2. CONTROLLING DIMENSION: MILLIMETERS.
3. DIMENSION b APPLIES TO PLATED TERMINAL AND IS MEASURED BETWEEN 0.15 AND 0.30 mm FROM THE TERMINAL TIP.

MILLIMETERS		
DIM	MIN	MAX
A	0.45	0.55
A1	0.00	0.05
A2	0.07	REF
b	0.20	0.30
D	1.45	BSC
E	1.00	BSC
e	0.50	BSC
L	0.30	0.40
L1	---	0.15

**MOUNTING FOOTPRINT**



DIMENSIONS: MILLIMETERS

\*For additional information on our Pb-Free strategy and soldering details, please download the ON Semiconductor Soldering and Mounting Techniques Reference Manual, SOLDERRM/D.

**GENERIC  
MARKING DIAGRAM\***



X = Specific Device Code  
M = Date Code

\*This information is generic. Please refer to device data sheet for actual part marking. Pb-Free indicator, "G" or microdot "▪", may or may not be present.

<b>DOCUMENT NUMBER:</b>	<b>98AON30313E</b>	Electronic versions are uncontrolled except when accessed directly from the Document Repository. Printed versions are uncontrolled except when stamped "CONTROLLED COPY" in red.
<b>DESCRIPTION:</b>	<b>UDFN6, 1.45x1.0, 0.5P</b>	<b>PAGE 1 OF 1</b>

onsemi and ONsemi are trademarks of Semiconductor Components Industries, LLC dba onsemi or its subsidiaries in the United States and/or other countries. onsemi reserves the right to make changes without further notice to any products herein. onsemi makes no warranty, representation or guarantee regarding the suitability of its products for any particular purpose, nor does onsemi assume any liability arising out of the application or use of any product or circuit, and specifically disclaims any and all liability, including without limitation special, consequential or incidental damages. onsemi does not convey any license under its patent rights nor the rights of others.

**onsemi**, **Onsemi**, and other names, marks, and brands are registered and/or common law trademarks of Semiconductor Components Industries, LLC dba "**onsemi**" or its affiliates and/or subsidiaries in the United States and/or other countries. **onsemi** owns the rights to a number of patents, trademarks, copyrights, trade secrets, and other intellectual property. A listing of **onsemi**'s product/patent coverage may be accessed at [www.onsemi.com/site/pdf/Patent-Marking.pdf](http://www.onsemi.com/site/pdf/Patent-Marking.pdf). **onsemi** reserves the right to make changes at any time to any products or information herein, without notice. The information herein is provided "as-is" and **onsemi** makes no warranty, representation or guarantee regarding the accuracy of the information, product features, availability, functionality, or suitability of its products for any particular purpose, nor does **onsemi** assume any liability arising out of the application or use of any product or circuit, and specifically disclaims any and all liability, including without limitation special, consequential or incidental damages. Buyer is responsible for its products and applications using **onsemi** products, including compliance with all laws, regulations and safety requirements or standards, regardless of any support or applications information provided by **onsemi**. "Typical" parameters which may be provided in **onsemi** data sheets and/or specifications can and do vary in different applications and actual performance may vary over time. All operating parameters, including "Typicals" must be validated for each customer application by customer's technical experts. **onsemi** does not convey any license under any of its intellectual property rights nor the rights of others. **onsemi** products are not designed, intended, or authorized for use as a critical component in life support systems or any FDA Class 3 medical devices or medical devices with a same or similar classification in a foreign jurisdiction or any devices intended for implantation in the human body. Should Buyer purchase or use **onsemi** products for any such unintended or unauthorized application, Buyer shall indemnify and hold **onsemi** and its officers, employees, subsidiaries, affiliates, and distributors harmless against all claims, costs, damages, and expenses, and reasonable attorney fees arising out of, directly or indirectly, any claim of personal injury or death associated with such unintended or unauthorized use, even if such claim alleges that **onsemi** was negligent regarding the design or manufacture of the part. **onsemi** is an Equal Opportunity/Affirmative Action Employer. This literature is subject to all applicable copyright laws and is not for resale in any manner.

## PUBLICATION ORDERING INFORMATION

### LITERATURE FULFILLMENT:

Email Requests to: [orderlit@onsemi.com](mailto:orderlit@onsemi.com)

**onsemi Website:** [www.onsemi.com](http://www.onsemi.com)

### TECHNICAL SUPPORT

**North American Technical Support:**

Voice Mail: 1 800-282-9855 Toll Free USA/Canada

Phone: 011 421 33 790 2910

**Europe, Middle East and Africa Technical Support:**

Phone: 00421 33 790 2910

For additional information, please contact your local Sales Representative