

SERIES: CFM-70 | **DESCRIPTION:** DC AXIAL FAN**FEATURES**

- 70 x 70 mm frame
- high fan speed for greater air flow
- dual ball bearing construction
- auto restart protection standard on all models



MODEL	input voltage		input current		input power	rated speed	air flow ¹	static pressure ²	noise
	rated (Vdc)	range (Vdc)	typ (A)	max (A)	max (W)	typ (RPM)	(CFM)	(inch H ₂ O)	max (dBA)
CFM-7010-13*	12	6~13.8	0.22	0.27	3.24	4,400	31.11	0.16	40.6

Notes: 1. At 0 inch H₂O static pressure.
 2. At 0 CFM airflow.
 *. Discontinued CFM-7010-13-20 and CFM-7010-13-22 models

PART NUMBER KEY**CFM-7010-13 - XX - CXX**

Base Number

Reserved for Custom Configurations

Fan Signals

10 = no signals

11 = rotation detector signal

20 = tachometer signal

22 = tachometer signal / PWM control signal

INPUT

parameter	conditions/description	min	typ	max	units
operating input voltage		6	12	13.8	Vdc
current			0.22	0.27	A
power			2.64	3.24	W
starting voltage	at 25°C		6		Vdc

PERFORMANCE

parameter	conditions/description	min	typ	max	units
rated speed	at 25°C, after 10 minutes	3,960	4,400	4,840	RPM
air flow	at 0 inch H ₂ O, see performance curves		31.11		CFM
static pressure	at 0 CFM, see performance curves		0.16		inch H ₂ O
noise	at 1 m		39.5	40.6	dB(A)

PROTECTIONS / SIGNALS¹

parameter	conditions/description	min	typ	max	units
auto restart protection	available on all models				
rotation detector	available on "11" models				
tachometer signal	available on "20" and "22" models				
PWM control signal	available on "22" models				

Notes: 1. See application notes for details.

SAFETY & COMPLIANCE

parameter	conditions/description	min	typ	max	units
insulation resistance of frame	at 500 Vdc between frame and positive terminal	10			MΩ
dielectric strength	at 500 Vac, 60 Hz, 1 minute between frame and positive terminal			5	mA
safety approvals	UL/cUL 507, TUV (EN 62368-1)				
EMI/EMC	EN 55022:2010+AC:2011 Class B, EN 61000-3-2:2014, EN 61000-3-3:2013, EN 55024:2010				
life expectancy	at 45°C, 15~65% RH		70,000		hours
RoHS	yes				

ENVIRONMENTAL

parameter	conditions/description	min	typ	max	units
operating temperature		-10		70	°C
storage temperature		-40		70	°C
operating humidity	non-condensing	5		90	%
storage humidity	non-condensing	5		95	%

PERFORMANCE CURVES

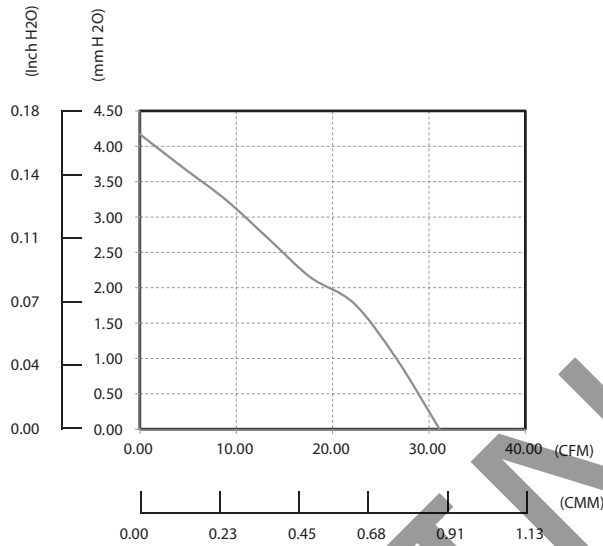

MECHANICAL

parameter	conditions/description	min	typ	max	units
motor	4 pole DC brushless				
bearing system	ball bearing				
direction of rotation	counter-clockwise viewed from front of fan blade				
dimensions	70 x 70 x 10.6				mm
material	PBT (UL94V-0)				
weight			37.3		g

MECHANICAL DRAWING

units: mm [inch]

wire: UL 1061, 26 AWG

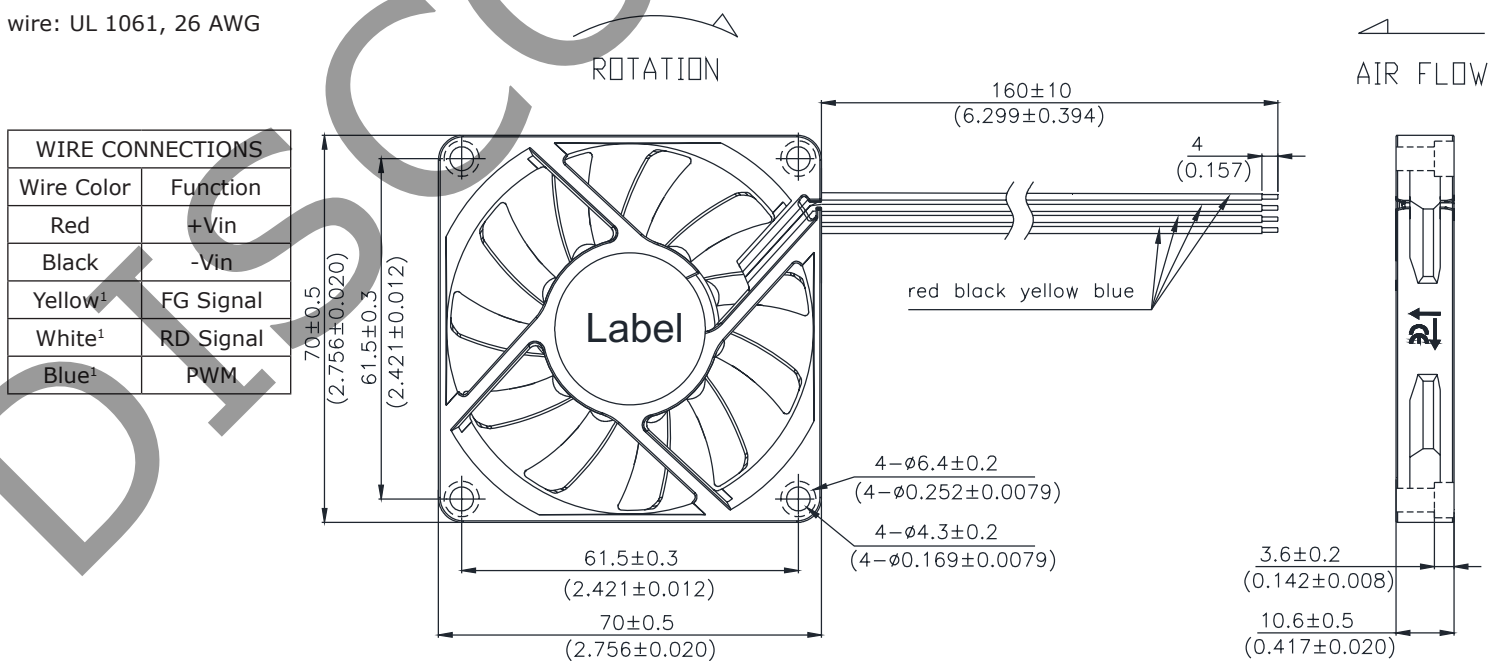

Note: 1. Wires only present on versions with output signals.

APPLICATION NOTES

Auto Restart Protection/Current Limit Protection

When the fan motor is locked, the device will cut off the drive current within two to six seconds and restart automatically after a few seconds. If the lock situation is continued, the device will work on a repeated cycle of cut-off and restart until the lock is released. (See Figure 1 below).

Figure 1 Current Limit Protection

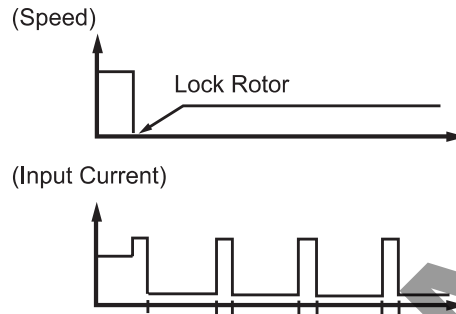

Lock Sensor/Rotation Detector

Lock Sensor is used to detect if the fan motor is operating or stopped. Alarm High: the output will be logical low when fan is operating and be logical high when fan motor is locked. (See Figures 2~3 below).

Figure 2 Alarm High Output Waveform



Figure 3 RD Signal Output Circuit: Open Collector

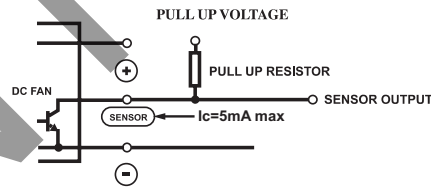

Pulse Sensor/Tachometer Signal/FG

Pulse Sensor is for detecting the rotational speed of the fan motor. At locked rotor condition, the signal stops cycling and the output is fixed at VoH or VoL (See Figures 4~5 below).

Figure 4 Output Waveform

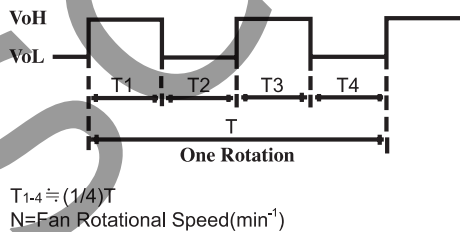
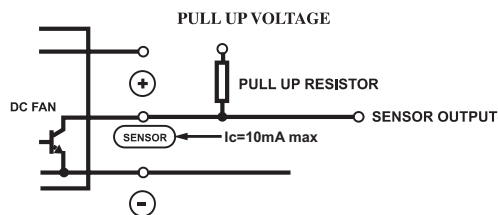

Figure 5 FG Signal Output Circuit: Open Collector



PMW Control Signal

A speed control lead can be provided that will accept a PWM signal from the customer circuit to vary the speed of the fan. The change in speed is linear by changing the Duty-Cycle of the PWM. Open collector type and pull-up voltage is changed by maximum operating voltage and sink current by consuming current. (See Figure 6 below).

Figure 6 Duty Cycle

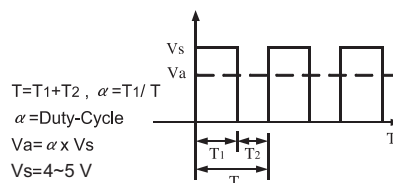

REVISION HISTORY

rev.	description	date
1.0	initial release	08/15/2016
1.01	updated datasheet	07/27/2017
1.02	updated to be certified to EN 62368-1 safety standard	07/09/2019
1.03	brand update	02/10/2020
1.04	updated drawing	06/12/2020
1.05	discontinued CFM-7010-13-20 and CFM-7010-13-22 models	04/28/2021

The revision history provided is for informational purposes only and is believed to be accurate.

CUI DEVICES

CUI Devices offers a one (1) year limited warranty. Complete warranty information is listed on our website.

CUI Devices reserves the right to make changes to the product at any time without notice. Information provided by CUI Devices is believed to be accurate and reliable. However, no responsibility is assumed by CUI Devices for its use, nor for any infringements of patents or other rights of third parties which may result from its use.

CUI Devices products are not authorized or warranted for use as critical components in equipment that requires an extremely high level of reliability. A critical component is any component of a life support device or system whose failure to perform can be reasonably expected to cause the failure of the life support device or system, or to affect its safety or effectiveness.