

NLX2G86

Dual 2-Input Exclusive-OR Gate

The NLX2G86 is a high performance dual 2-input Exclusive-OR Gate operating from a 1.65 V to 5.5 V supply.

Features

- Extremely High Speed: t_{PD} 2.4 ns (typical) at $V_{CC} = 5.0$ V
- Designed for 1.65 V to 5.5 V V_{CC} Operation
- Over Voltage Tolerant Inputs and Outputs
- LVTTL Compatible – Interface Capability With 5.0 V TTL Logic with $V_{CC} = 3.0$ V
- LVCMOS Compatible
- 24 mA Balanced Output Sink and Source Capability
- Near Zero Static Supply Current Substantially Reduces System Power Requirements
- Replacement for NC7WZ86
- This is a Pb-Free Device

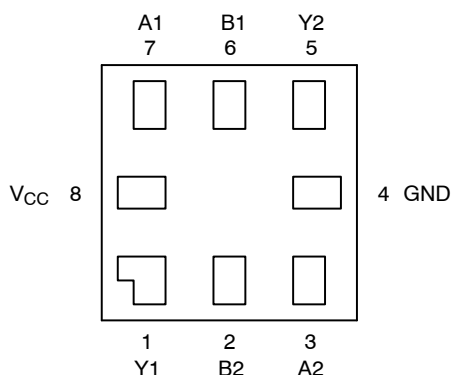

Figure 1. Pinout (Top View)

PIN ASSIGNMENT

Pin	Function
1	Y1
2	B2
3	A2
4	GND
5	Y2
6	B1
7	A1
8	V_{CC}



ON Semiconductor®

<http://onsemi.com>



UQFN8
MU SUFFIX
CASE 523AN

MARKING DIAGRAM

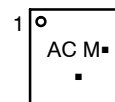

AC = Device Code
M = Date Code*
▪ = Pb-Free Package

(Note: Microdot may be in either location)

ORDERING INFORMATION

See detailed ordering and shipping information in the package dimensions section on page 4 of this data sheet.

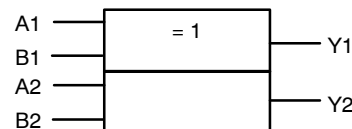

Figure 2. Logic Symbol

FUNCTION TABLE

Input		Output $Y = A + B$
A	B	Y
L	L	L
L	H	H
H	L	H
H	H	L

NLX2G86

MAXIMUM RATINGS

Symbol	Parameter	Value	Unit
V _{CC}	DC Supply Voltage	-0.5 to +7.0	V
V _I	DC Input Voltage	-0.5 to +7.0	V
V _O	DC Output Voltage	-0.5 to +7.0	V
I _{IK}	DC Input Diode Current V _I < GND	-50	mA
I _{OK}	DC Output Diode Current V _O < GND	-50	mA
I _O	DC Output Sink Current	±50	mA
I _{CC}	DC Supply Current per Supply Pin	±100	mA
I _{GND}	DC Ground Current per Ground Pin	±100	mA
T _{STG}	Storage Temperature Range	-65 to +150	°C
T _L	Lead Temperature, 1 mm from Case for 10 Seconds	260	°C
T _J	Junction Temperature under Bias	+150	°C
θ _{JA}	Thermal Resistance (Note 1)	TBD	°C/W
P _D	Power Dissipation in Still Air at 85°C	TBD	mW
MSL	Moisture Sensitivity	Level 1	
F _R	Flammability Rating Oxygen Index: 28 to 34	UL 94 V-0 @ 0.125 in	
V _{ESD}	ESD Withstand Voltage Human Body Model (Note 2) Machine Model (Note 3) Charged Device Model (Note 4)	> 2000 > 200 N/A	V

Stresses exceeding Maximum Ratings may damage the device. Maximum Ratings are stress ratings only. Functional operation above the Recommended Operating Conditions is not implied. Extended exposure to stresses above the Recommended Operating Conditions may affect device reliability.

1. Measured with minimum pad spacing on an FR4 board, using 10 mm-by-1 inch, 2 ounce copper trace with no air flow.
2. Tested to EIA/JESD22-A114-A.
3. Tested to EIA/JESD22-A115-A.
4. Tested to JESD22-C101-A.

RECOMMENDED OPERATING CONDITIONS

Symbol	Parameter	Min	Max	Unit
V _{CC}	Supply Voltage Operating Data Retention Only	1.65 1.5	5.5 5.5	V
V _I	Input Voltage (Note 5)	0	5.5	V
V _O	Output Voltage (HIGH or LOW State)	0	5.5	V
T _A	Operating Free-Air Temperature	-40	+125	°C
Δt/ΔV	Input Transition Rise or Fall Rate V _{CC} = 1.8 V ± 0.15 V V _{CC} = 2.5 V ± 0.2 V V _{CC} = 3.0 V ± 0.3 V V _{CC} = 5.0 V ± 0.5 V	0 0 0 0	20 20 10 5	ns/V

5. Unused inputs may not be left open. All inputs must be tied to a high- or low-logic input voltage level.

NLX2G86

DC ELECTRICAL CHARACTERISTICS

Symbol	Parameter	V _{CC} (V)	T _A = 25°C			-40°C ≤ T _A ≤ 85°C		Unit	Condition
			Min	Typ	Max	Min	Max		
V _{IH}	High-Level Input Voltage	1.65 to 1.95 2.3 to 5.5	0.75 V _{CC} 0.7 V _{CC}			0.75 V _{CC} 0.7 V _{CC}		V	
V _{IL}	Low-Level Input Voltage	1.65 to 1.95 2.3 to 5.5			0.25 V _{CC} 0.3 V _{CC}		0.25 V _{CC} 0.3 V _{CC}	V	
V _{OH}	High-Level Output Voltage V _{IN} = V _{IH}	1.65 1.8 2.3 3.0 4.5	1.55 1.7 2.2 2.9 4.4	1.65 1.8 2.3 3.0 4.5		1.55 1.7 2.2 2.9 4.4		V	I _{OH} = -100 μA
		1.65 2.3 3.0 3.0 4.5	1.29 1.9 2.4 2.3 3.8	1.52 2.15 2.80 2.68 4.20		1.29 1.9 2.4 2.3 3.8		V	I _{OH} = -4 mA I _{OH} = -8 mA I _{OH} = -16 mA I _{OH} = -24 mA I _{OH} = -32 mA
V _{OL}	Low-Level Output Voltage V _{IN} = V _{IL}	1.65 1.8 2.3 3.0 4.5		0.0 0.0 0.0 0.0 0.0	0.1 0.1 0.1 0.1 0.1		0.1 0.1 0.1 0.1 0.1	V	I _{OL} = 100 μA
		1.65 2.3 3.0 3.0 4.5		0.08 0.10 0.15 0.22 0.22	0.24 0.30 0.40 0.55 0.55		0.24 0.30 0.40 0.55 0.55	V	I _{OL} = 4 mA I _{OL} = 8 mA I _{OL} = 16 mA I _{OL} = 24 mA I _{OL} = 32 mA
I _{IN}	Input Leakage Current	0 to 5.5			±1.0		±1.0	μA	0 V ≤ V _{IN} ≤ 5.5 V
I _{OFF}	Power Off Leakage Current	0.0			1.0		10	μA	V _{IN} or V _{OUT} = 5.5 V
I _{CC}	Quiescent Supply Current	1.65 to 5.5			1.0		10	μA	V _{IN} = 5.5 V, GND

AC ELECTRICAL CHARACTERISTICS t_R = t_F = 3.0 ns

Symbol	Parameter	Condition	V _{CC} (V)	T _A = 25°C			-40°C ≤ T _A ≤ 125°C		Unit
				Min	Typ	Max	Min	Max	
t _{PLH} t _{PHL}	Propagation Delay (Figure 3 and 4)	R _L = 1 MΩ, C _L = 15 pF	1.8 ± 0.15	2.0	7.9	9.0	2.0	10.5	ns
		R _L = 1 MΩ, C _L = 15 pF	2.5 ± 0.2	1.2	4.1	7.0	1.2	7.5	
		R _L = 1 MΩ, C _L = 15 pF	3.3 ± 0.3	0.8	3.0	4.8	0.8	5.2	
		R _L = 500 Ω, C _L = 50 pF		1.2	3.8	5.4	1.2	5.9	
		R _L = 1 MΩ, C _L = 15 pF	5.0 ± 0.5	0.5	2.2	3.5	0.5	3.8	
		R _L = 500 Ω, C _L = 50 pF		0.8	2.9	4.2	1.0	4.6	

CAPACITIVE CHARACTERISTICS

Symbol	Parameter	Condition	Typical	Unit
C _{IN}	Input Capacitance	V _{CC} = 5.5 V, V _I = 0 V or V _{CC}	2.5	pF
C _{PD}	Power Dissipation Capacitance (Note 6)	10 MHz, V _{CC} = 3.3 V, V _I = 0 V or V _{CC}	9	pF
		10 MHz, V _{CC} = 5.5 V, V _I = 0 V or V _{CC}	11	

6. C_{PD} is defined as the value of the internal equivalent capacitance which is calculated from the operating current consumption without load. Average operating current can be obtained by the equation: I_{CC(OPR)} = C_{PD} • V_{CC} • f_{in} + I_{CC}. C_{PD} is used to determine the no-load dynamic power consumption; P_D = C_{PD} • V_{CC}² • f_{in} + I_{CC} • V_{CC}.

NLX2G86

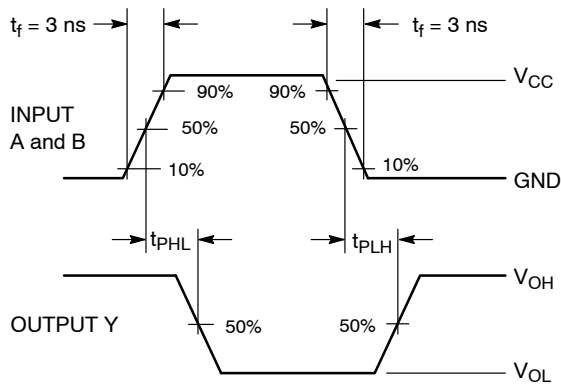
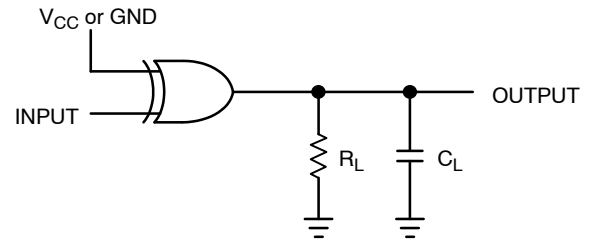

Figure 3. Switching Waveform



A 1-MHz square input wave is recommended for propagation delay tests.

Figure 4. Test Circuit

DEVICE ORDERING INFORMATION

Device Order Number	Package Type	Tape and Reel Size [†]
NLX2G86MUTCG	UQFN8 (Pb-Free)	3000 Units / Tape & Reel

[†]For information on tape and reel specifications, including part orientation and tape sizes, please refer to our Tape and Reel Packaging Specifications Brochure, BRD8011/D.

MECHANICAL CASE OUTLINE

PACKAGE DIMENSIONS

ON Semiconductor®



SCALE 4:1

UQFN8, 1.6x1.6, 0.5P
CASE 523AN-01
ISSUE O

DATE 26 NOV 2008

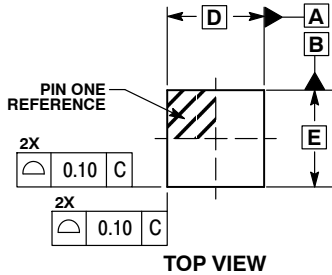

TOP VIEW

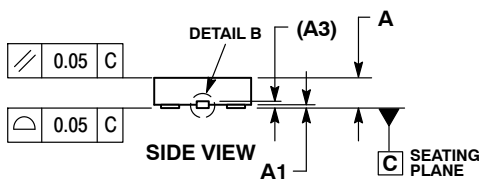

SIDE VIEW

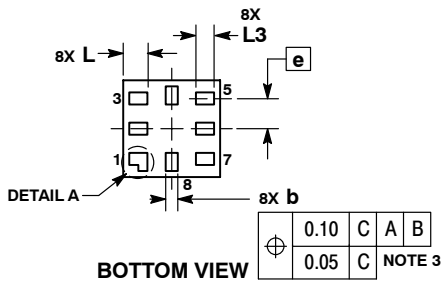

BOTTOM VIEW

\varnothing	0.10	C	A	B
	0.05	C	NOTE 3	

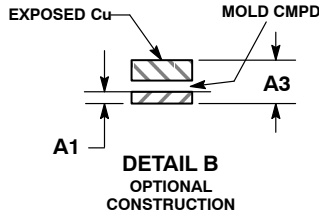

DETAIL B
OPTIONAL
CONSTRUCTION

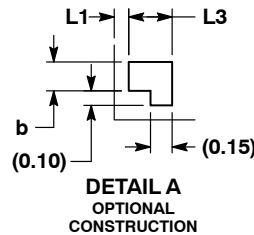

DETAIL A
OPTIONAL
CONSTRUCTION

NOTES:

1. DIMENSIONING AND TOLERANCING PER ASME Y14.5M, 1994.
2. CONTROLLING DIMENSION: MILLIMETERS.
3. DIMENSION b APPLIES TO PLATED TERMINAL AND IS MEASURED BETWEEN 0.15 AND 0.30 mm FROM THE TERMINAL TIP.

DIM	MILLIMETERS	
	MIN	MAX
A	0.45	0.60
A1	0.00	0.05
A3	0.13 REF	
b	0.15	0.25
D	1.60 BSC	
E	1.60 BSC	
e	0.50 BSC	
L	0.35	0.45
L1	---	0.15
L3	0.25	0.35

GENERIC MARKING DIAGRAM*

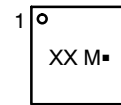

- XX = Specific Device Code
- M = Date Code
- = Pb-Free Package

*This information is generic. Please refer to device data sheet for actual part marking.
Pb-Free indicator, "G" or microdot "■", may or may not be present.

SOLDERING FOOTPRINT*

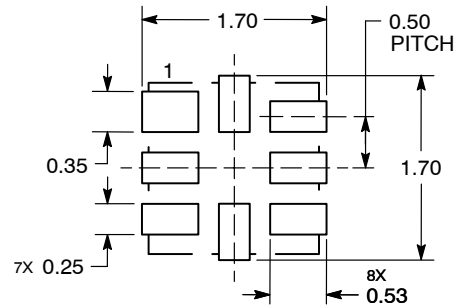

DIMENSIONS: MILLIMETERS

*For additional information on our Pb-Free strategy and soldering details, please download the ON Semiconductor Soldering and Mounting Techniques Reference Manual, SOLDERRM/D.

DOCUMENT NUMBER:	98AON36348E	Electronic versions are uncontrolled except when accessed directly from the Document Repository. Printed versions are uncontrolled except when stamped "CONTROLLED COPY" in red.
DESCRIPTION:	8 PIN UQFN, 1.6X1.6, 0.5P	PAGE 1 OF 1

ON Semiconductor and ON are trademarks of Semiconductor Components Industries, LLC dba ON Semiconductor or its subsidiaries in the United States and/or other countries. ON Semiconductor reserves the right to make changes without further notice to any products herein. ON Semiconductor makes no warranty, representation or guarantee regarding the suitability of its products for any particular purpose, nor does ON Semiconductor assume any liability arising out of the application or use of any product or circuit, and specifically disclaims any and all liability, including without limitation special, consequential or incidental damages. ON Semiconductor does not convey any license under its patent rights nor the rights of others.

onsemi, **Onsemi**, and other names, marks, and brands are registered and/or common law trademarks of Semiconductor Components Industries, LLC dba "**onsemi**" or its affiliates and/or subsidiaries in the United States and/or other countries. **onsemi** owns the rights to a number of patents, trademarks, copyrights, trade secrets, and other intellectual property. A listing of **onsemi**'s product/patent coverage may be accessed at www.onsemi.com/site/pdf/Patent-Marking.pdf. **onsemi** reserves the right to make changes at any time to any products or information herein, without notice. The information herein is provided "as-is" and **onsemi** makes no warranty, representation or guarantee regarding the accuracy of the information, product features, availability, functionality, or suitability of its products for any particular purpose, nor does **onsemi** assume any liability arising out of the application or use of any product or circuit, and specifically disclaims any and all liability, including without limitation special, consequential or incidental damages. Buyer is responsible for its products and applications using **onsemi** products, including compliance with all laws, regulations and safety requirements or standards, regardless of any support or applications information provided by **onsemi**. "Typical" parameters which may be provided in **onsemi** data sheets and/or specifications can and do vary in different applications and actual performance may vary over time. All operating parameters, including "Typicals" must be validated for each customer application by customer's technical experts. **onsemi** does not convey any license under any of its intellectual property rights nor the rights of others. **onsemi** products are not designed, intended, or authorized for use as a critical component in life support systems or any FDA Class 3 medical devices or medical devices with a same or similar classification in a foreign jurisdiction or any devices intended for implantation in the human body. Should Buyer purchase or use **onsemi** products for any such unintended or unauthorized application, Buyer shall indemnify and hold **onsemi** and its officers, employees, subsidiaries, affiliates, and distributors harmless against all claims, costs, damages, and expenses, and reasonable attorney fees arising out of, directly or indirectly, any claim of personal injury or death associated with such unintended or unauthorized use, even if such claim alleges that **onsemi** was negligent regarding the design or manufacture of the part. **onsemi** is an Equal Opportunity/Affirmative Action Employer. This literature is subject to all applicable copyright laws and is not for resale in any manner.

PUBLICATION ORDERING INFORMATION

LITERATURE FULFILLMENT:

Email Requests to: orderlit@onsemi.com

onsemi Website: www.onsemi.com

TECHNICAL SUPPORT

North American Technical Support:

Voice Mail: 1 800-282-9855 Toll Free USA/Canada

Phone: 011 421 33 790 2910

Europe, Middle East and Africa Technical Support:

Phone: 00421 33 790 2910

For additional information, please contact your local Sales Representative