

NCP2815

NOCAP™ LongPlay Headphone Amplifier

NCP2815 is a dual LongPlay true ground headphone amplifier designed for portable communication device applications such as mobile phones. This part is capable of delivering 26 mW of continuous average power into a 32 Ω load from a 1.8 V power supply with a THD+N of 1%.

Based on the power supply delivered to the device, an internal power management block generates a symmetrical positive and negative voltage. Thus, the internal amplifiers provide outputs referenced to Ground and the losses are reduced which helps to increase the battery life. In this NOCAP configuration, the two external heavy coupling capacitors can be removed. This provides a significant space and cost savings compared to a typical stereo application.

NCP2815 is available with an external adjustable gain (version A), or internal gain of -1.5 V/V (version B). It reaches a superior -100 dB PSRR and noise floor. Thus, it offers high fidelity audio sound, as well as a direct connection to the battery. It contains circuitry to prevent “Pop & Click” noise that would otherwise occur during turn-on and turn-off transitions. The device is available in 12 bump CSP package (1.2 x 1.6 mm) which helps to save space on the board.

Features

- NOCAP Output Eliminates DC-Blocking Capacitors:
 - ◆ Saves Board Area
 - ◆ Saves Component Cost
 - ◆ No Low-Frequency Response Attenuation
- LongPlay Architecture: Increase the Battery Life
- High PSRR (-100 dB): Direct Connection to the Battery
- “Pop and Click” Noise Protection Circuitry
- Internal Gain (-1.5 V/V) or External Adjustable Gain
- Ultra Low Current Shutdown Mode
- High Impedance Mode
- 1.6 V – 3.6 V Operation
- Thermal Overload Protection Circuitry
- CSP 1.2 x 1.6 mm
- These Devices are Pb-Free, Halogen Free/BFR Free and are RoHS Compliant

Typical Applications

- Headset Audio Amplifier for
 - ◆ Cellular Phones
 - ◆ MP3 player
 - ◆ Personal Digital Assistant and Portable Media Player
 - ◆ Portable Devices



ON Semiconductor®

<http://onsemi.com>



12 PIN CSP
FC SUFFIX
CASE 499BJ

MARKING DIAGRAM

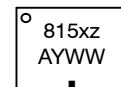

- x = A for NCP2815A
= B for NCP2815B
- z = C for Backside laminate
- A = Assembly Location
- Y = Year
- WW = Work Week
- = Pb-Free Package

Pin Configuration

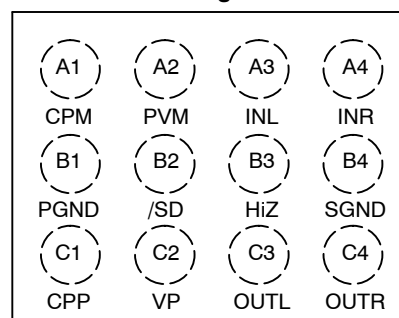

(Top View)

ORDERING INFORMATION

See detailed ordering and shipping information on page 10 of this data sheet.

NCP2815

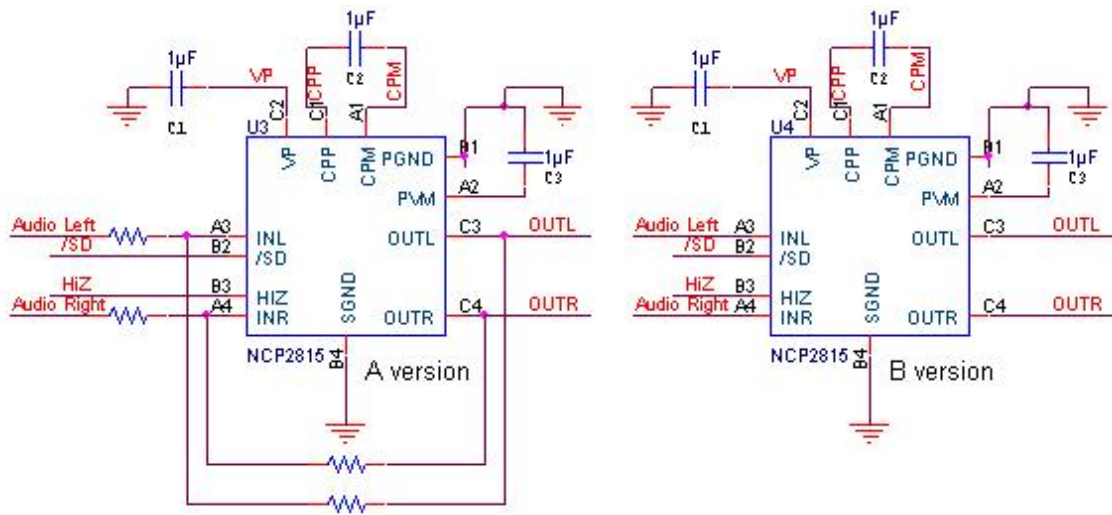

Figure 1. Typical Application Circuit

NCP2815

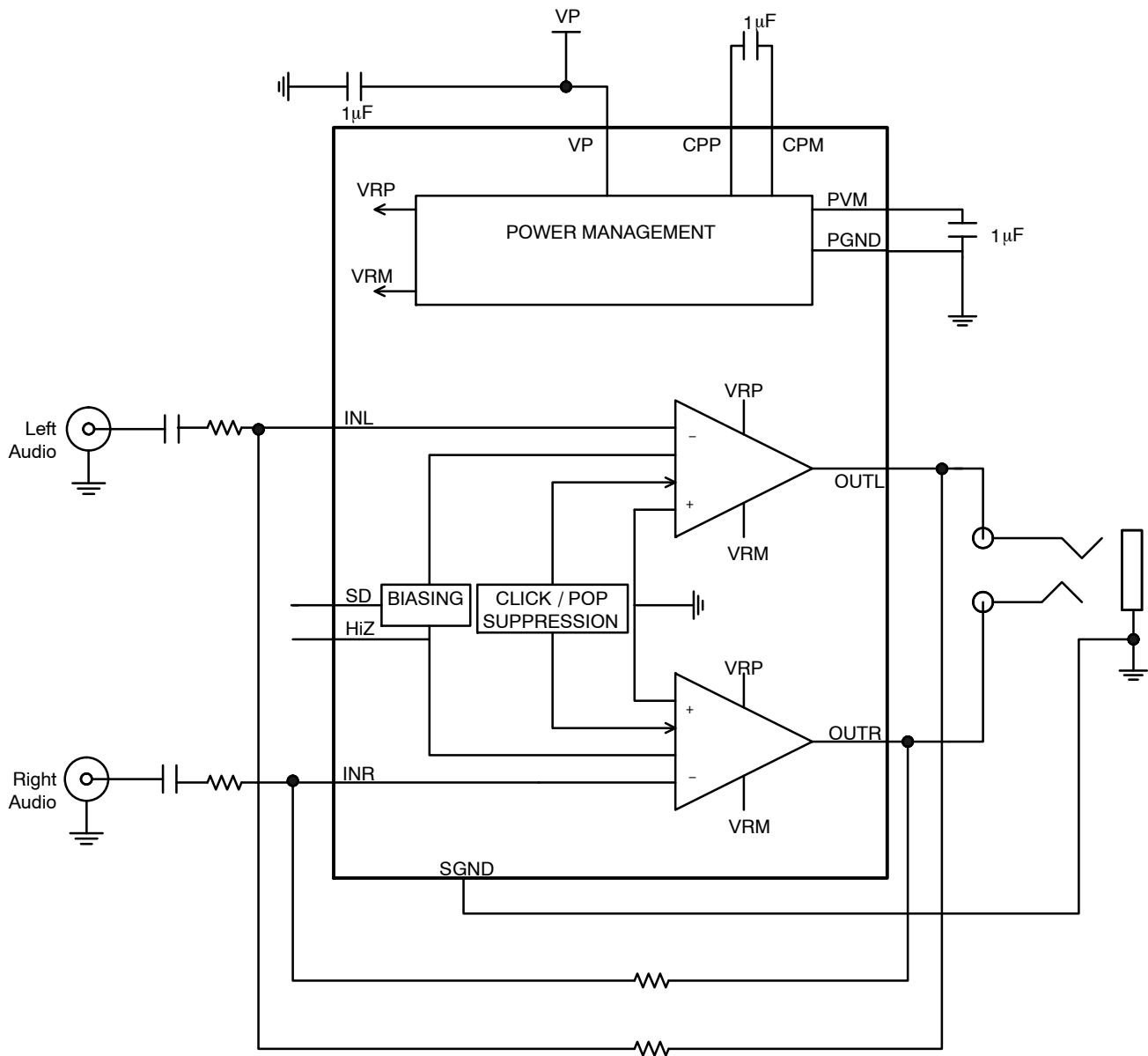

Figure 2. Typical Application Schematic Version A

NCP2815

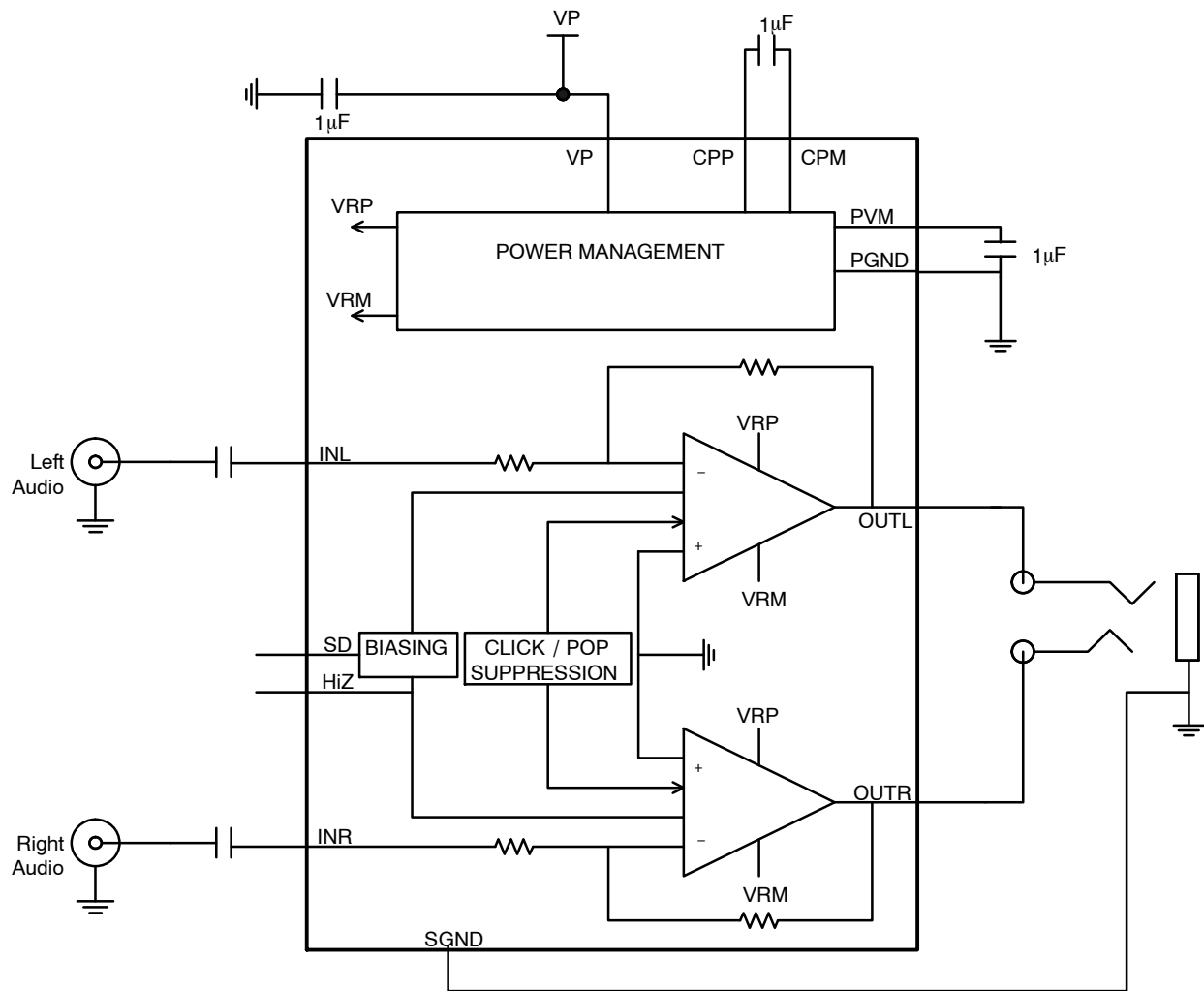

Figure 3. Typical Application Schematic Version B

PIN FUNCTION DESCRIPTION

Pin	Pin Name	Type	Description
A1	CPM	Input / Output	Charge pump flying capacitor negative terminal. A 1 µF ceramic filtering capacitor to CPP is required
A2	PVM	Output	Charge pump output. A 1 µF ceramic filtering capacitor to ground is required
A3	INL	Input	Left input of the audio source
A4	INR	Input	Right input of the audio source
B1	PGND	Ground	Power ground
B2	/SD	Input	Enable activation.
B4	SGND	Ground	Sense Ground. Connect to shield terminal of headphone jack or ground plane.
C1	CPP	Input / Output	Charge pump flying capacitor positive terminal. A 1 µF ceramic filtering capacitor to CPM is required.
C2	VP	Power	Positive supply voltage, connected to a Lithium/Ion battery or other power supply.
C3	OUTL	Output	Left audio channel output signal
C4	OUTR	Output	Right audio channel output signal
B3	HiZ	Input	Output high impedance mode activation.

NCP2815

MAXIMUM RATINGS

Rating	Symbol	Value	Unit
V _P Pin: Power Supply Voltage (Note 1)	V _{IN}	-0.3 to + 4.5	V
INL, INR, /SD pins	V _{mr1}	-0.3 to V _P + 0.3	V
HiZ, OUTL, OUTR pins	V _{mr2}	-0.3 - V _P to V _P + 0.3	V
Human Body Model (HBM) ESD Rating are (Note 2)	ESD HBM	2000	V
Machine Model (MM) ESD Rating are (Note 2)	ESD MM	200	V
CSP 1.2 x 1.6 mm package (Notes 6 and 7) Thermal Resistance Junction to Case	R _{θJC}	(Note 7)	°C/W
Operating Ambient Temperature Range	T _A	-40 to + 85	°C
Operating Junction Temperature Range	T _J	-40 to + 125	°C
Maximum Junction Temperature (Note 6)	T _{JMAX}	+ 150	°C
Storage Temperature Range	T _{STG}	-65 to + 150	°C
Moisture Sensitivity (Note 5)	MSL	Level 1	

Stresses exceeding Maximum Ratings may damage the device. Maximum Ratings are stress ratings only. Functional operation above the Recommended Operating Conditions is not implied. Extended exposure to stresses above the Recommended Operating Conditions may affect device reliability.

1. Maximum electrical ratings are defined as those values beyond which damage to the device may occur at T_A = 25 °C.
2. According to JEDEC standard JESD22-A108B.
3. This device series contains ESD protection and passes the following tests:
Human Body Model (HBM) ±2.0 kV per JEDEC standard: JESD22-A114 for all pins.
Machine Model (MM) ±200 V per JEDEC standard: JESD22-A115 for all pins.
4. Latch up Current Maximum Rating: ±100 mA per JEDEC standard: JESD78 class II.
5. Moisture Sensitivity Level (MSL): 1 per IPC/JEDEC standard: J-STD-020A.
6. The thermal shutdown set to 160°C (typical) avoids irreversible damage on the device due to power dissipation.
7. The R_{θCA} is dependent on the PCB heat dissipation. The maximum power dissipation (P_D) is dependent on the min input voltage, the max output current and the selected external components.

$$R_{\theta CA} = \frac{125 - T_A}{P_D} - R_{\theta JC}$$

NCP2815

ELECTRICAL CHARACTERISTICS Min & Max Limits apply for T_A between -40°C to $+85^{\circ}\text{C}$ and T_J up to $+125^{\circ}\text{C}$ for V_{IN} between 1.6 V to 3.6 V (Unless otherwise noted). Typical values are referenced to $T_A = +25^{\circ}\text{C}$ and $V_P = 1.8\text{ V}$.

Symbol	Parameter	Conditions	Min	Typ	Max	Unit
V_{BAT}	Supply voltage range		1.6		3.6	V
I_{SD}	Shutdown current				1	μA
I_Q	Quiescent current	$V_P = 1.8\text{ V}$		1.6	2.2	mA
R_{IN}	Input resistance		15	20	25	$\text{k}\Omega$
R_{SD}	/SD pull-down resistor			300		$\text{k}\Omega$
R_{HiZ}	HiZ pull-down resistor			150		$\text{k}\Omega$
	Maximum input signal swing			2.8		V_{P-P}
V_{IH}	High-level input voltage SD and HiZ pin		1.2			V
V_{IL}	Low-level input voltage SD and HiZ pin				0.4	V
UVLO	UVLO threshold	Falling edge		1.4		V
UVLO _{HYS}	UVLO hysteresis			100		mV
T_{SD}	Thermal shutdown temperature			160		$^{\circ}\text{C}$
V_{OS}	Output offset voltage	Input AC grounded		± 0.5		mV
T_{WU}	Turning On time			1		ms
V_{LP}	Max Output Swing (peak value) (Note 8)	$HSV_{BAT} = 1.8\text{ V}$, Headset = $32\ \Omega$	1.13			V_{peak}
P_O	Max Output Power (Note 8)	$HSV_{BAT} = 1.8\text{ V}$, THD+N = 1% Headset = $16\ \Omega$ Headset = $32\ \Omega$	20	35 32		mW
P_O	Max Output Power	$HSV_{BAT} = 3.6\text{ V}$, THD+N = 1% Headset = $16\ \Omega$ Headset = $32\ \Omega$		62 35		mW
	Crosstalk (Note 8)	Headset $\geq 16\ \Omega$		-80	-60	dB
PSRR	Power Supply Rejection Ratio	Inputs Shorted to Ground $F = 217\text{ Hz}$ to 1 kHz		-100		dB
THD+N	Total Harmonic Distortion + Noise	Headset = $16\ \Omega$ $P_{OUT} = 10\text{ mW}$, $F = 1\text{ kHz}$		0.03		%
THD+N	Total Harmonic Distortion + Noise	Headset = $32\ \Omega$ $P_{OUT} = 10\text{ mW}$, $F = 1\text{ kHz}$		0.01		%
THD+N	Total Harmonic Distortion + Noise	Headset = $32\ \Omega$ $V_{OUT} = 400\text{ mV}$, $F = 1\text{ kHz}$		-78		dB
SNR	Signal to noise ratio			100		dB
Z_{SD}	Output Impedance in Shutdown Mode			20		$\text{k}\Omega$
Z_{HiZ}	Output Impedance in High Impedance Mode		15	20	25	$\text{k}\Omega$
	Max channel to channel gain tolerance	B Version only, $T_A = +25^{\circ}\text{C}$	-2	± 0.3	+2	%
F_{SW1}	Headset charge pump switching frequency	$P_{OUT} > 500\ \mu\text{W}$		1		MHz
F_{SW2}	Headset charge pump switching frequency	$P_{OUT} < 500\ \mu\text{W}$		125		kHz
A_V	Voltage Gain	B version only	-1.54	-1.5	-1.46	V/V

8. Guaranteed by design and characterized.

9. Typical application circuit as depicted

TYPICAL OPERATING CHARACTERISTICS

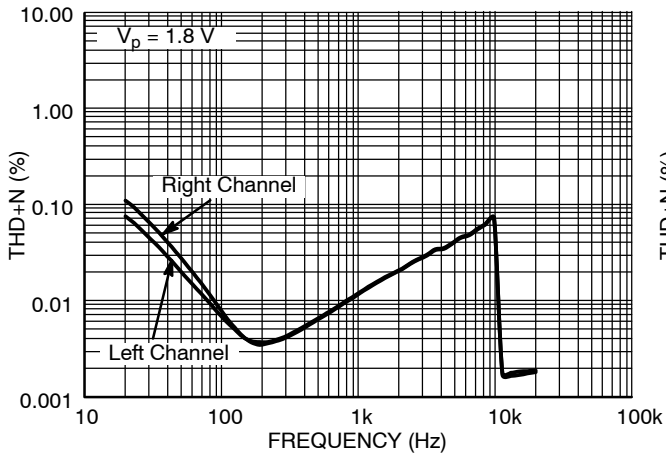

Figure 4. THD+N vs Frequency in Phase, 32 Ω Load, $P_{out} = 10$ mW

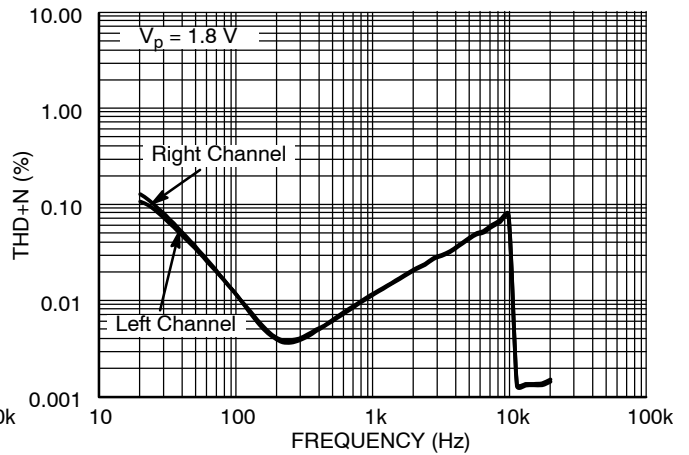

Figure 5. THD+N vs Frequency in Phase, 32 Ω Load, $P_{out} = 10$ mW

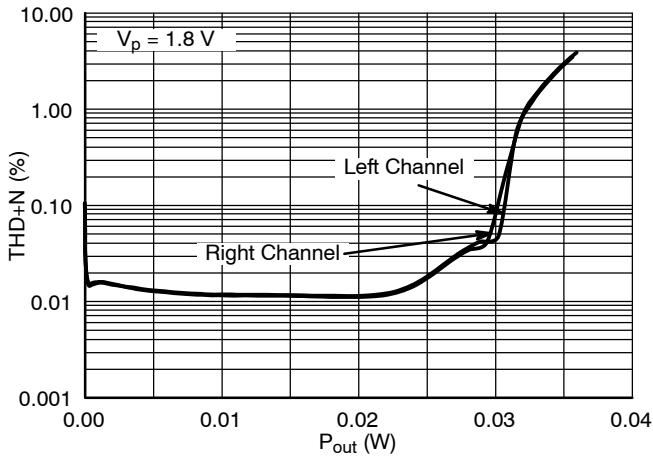

Figure 6. THD+N vs P_{out} , 32 Ω Load

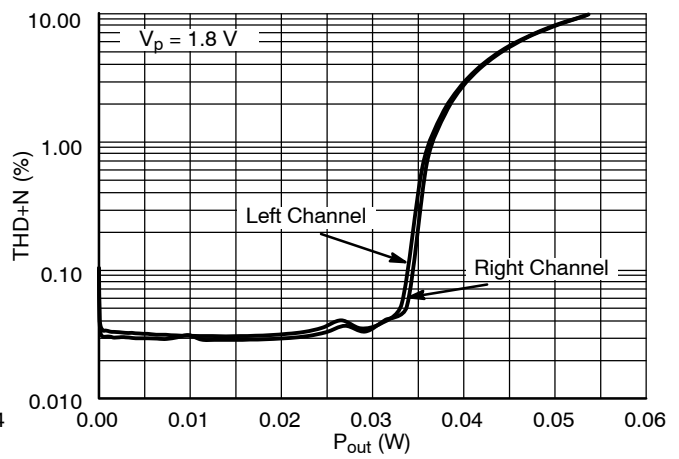

Figure 7. THD+N vs P_{out} , 16 Ω Load

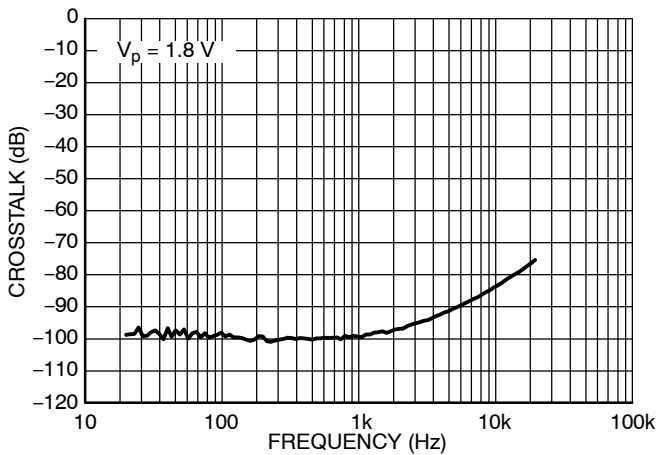

Figure 8. Power Supply Rejection Ratio vs. Frequency

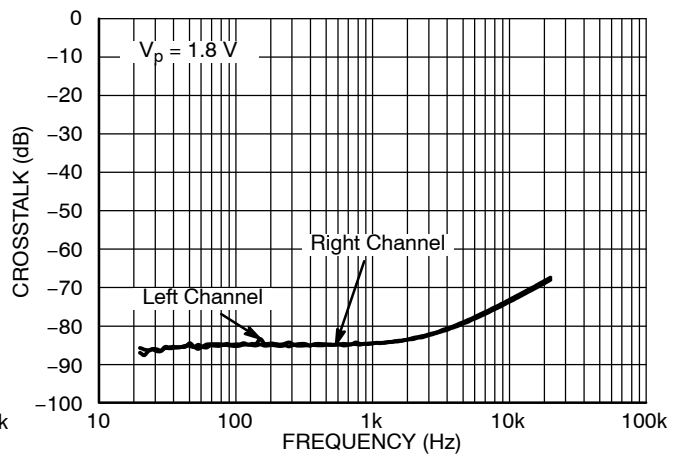

Figure 9. Crosstalk vs. Frequency, $R_{load} = 32 \Omega$, $P_{out} = 10$ mW

NCP2815

TYPICAL OPERATING CHARACTERISTICS

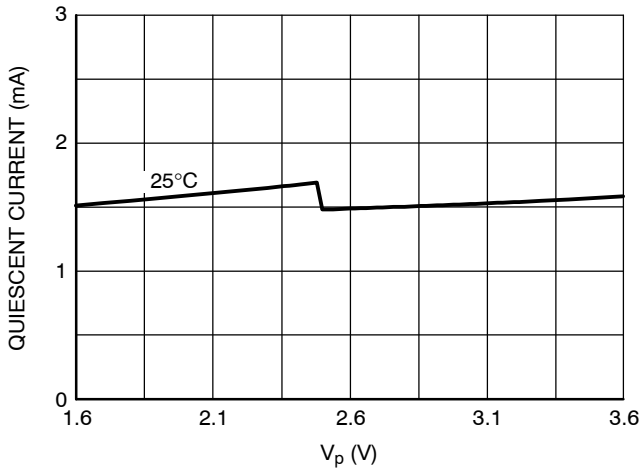

Figure 10. Quiescent Current vs Power Supply

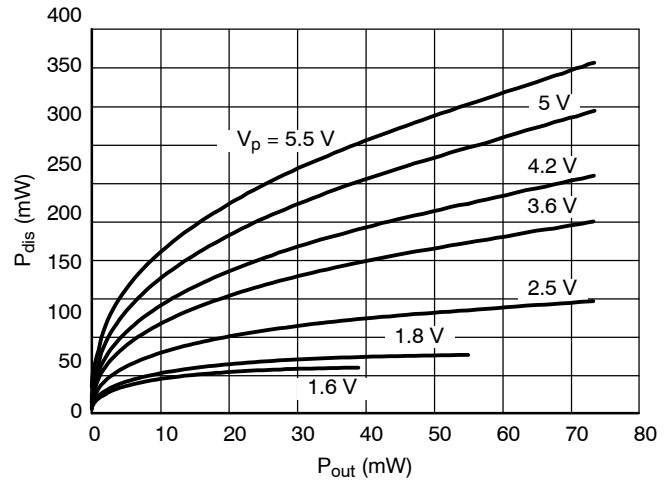

Figure 11. Power Dissipation vs P_{out} Left and Right in Phase

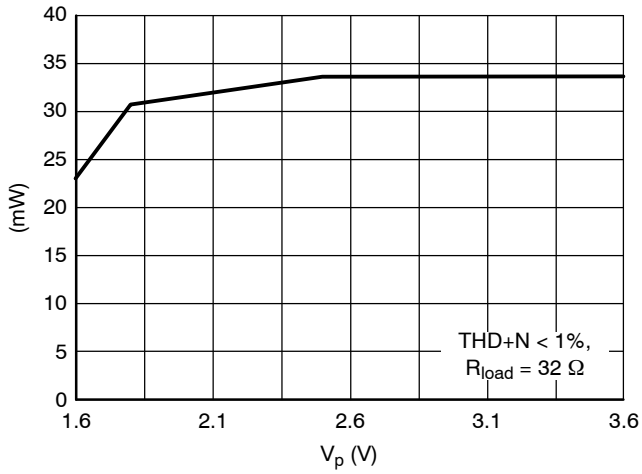

Figure 12. Max Output Power vs V_p , 32 Ω Load

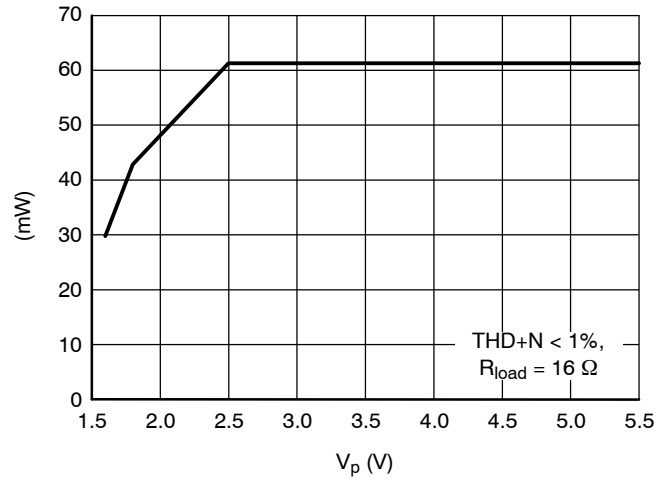

Figure 13. Max Output Power vs V_p , 16 Ω Load

DETAIL OPERATING DESCRIPTION

Detailed Description

The NCP2815 is a stereo headphone amplifier with NOCAP architecture. This architecture eliminates the need to use two big external capacitors required by conventional headphone amplifier.

The structure of the NCP2815 is composed of two true ground amplifiers, a UVLO, a short circuit protection and a thermal shutdown circuit. Additionally, a special circuit is embedded to eliminate any pop and click noise that occurs during turn on and turn off time. Version A has an external gain selectable by two resistors, Version B has a gain of 1.5 V/V.

NOCAP

NOCAP is a patented architecture which requires only 2 small ceramic capacitors. It generates a symmetrical positive and negative voltage which it allows the output of the amplifiers to be biased to ground.

LongPlay Architecture

NCP2815 includes a LongPlay architecture which helps to save battery life by reducing the quiescent current. The charge pump frequency is reduced to 125 kHz for an output load < 500 μ W.

Current Limit Protection Circuit

The NCP2815 contains protection circuitry against shorts to ground. The current is limited to 300 mA when an output is shorted to GND and a signal appears at the input.

Thermal Overload Protection

Internal amplifiers are switched off when the temperature exceeds 160°C, and are switched back on when the temperature decreases below 140°C.

Under Voltage Lockout

When the battery voltage decreases below 1.4 V, the amplifiers are turned off. The hysteresis required to turn back on the device is 100 mV.

Pop and Click Suppression Circuitry

The NCP2815 includes a special circuit to eliminate any pop and click noise during turn on and turn off time. The amplifier creates an offset during these transitions at the output which give a parasitic noise called “pop and click noise”. The NCP2815 eliminates this problem.

Gain Setting Resistor Selection (R_{in} and R_f, A Version Only)

R_{in} and R_f set the closed loop gain of the amplifier. A low gain configuration (close to 1) minimizes the THD + noise values and maximizes the signal to noise ratio.

A closed loop gain in the range of 1 to 10 is recommended to optimize overall system performance.

The formula to calculate the gain is:

$$A_v = - \frac{R_f}{R_{in}}$$

Input Capacitor Selection

The input coupling capacitor blocks the DC voltage at the amplifier input terminal. This capacitor creates a high-pass filter with R_{in} (externally selectable for Version A, 20 k Ω for Version B).

The size of the capacitor must be large enough to couple in the low frequencies without severe attenuation in the audio bandwidth (20 Hz – 20 kHz).

The cut off frequency for the input high-pass filter is :

$$F_c = \frac{1}{2\pi R_{in} C_{in}}$$

A $F_c < 20$ Hz is recommended.

Charge Pump Capacitor Selection

Use a ceramic capacitor with low ESR for better performances. An X5R / X7R capacitor is recommended.

The flying capacitor (C2) serves to transfer charge during the generation of the negative voltage.

The PVM capacitor (C3) must be equal at least to the flying capacitor to allow maximum transfer charge.

Table 1 suggests typical values and manufacturers:

Table 1.

Value	Reference	Package	Manufacturer
1 μ F	C1005X5R0J105K	0402	TDK
1 μ F	GRM155R60J105K19	0402	Murata

Lower value capacitors can be used but the maximum output power is reduced and the device may not operate to specifications.

Power Supply Decoupling Capacitor (C1)

The NCP2815 is a True Ground amplifier which requires an adequate decoupling capacitor to reduce noise and THD + N. It is recommended to use an X5R / X7R ceramic capacitor with a value of 1 μ F and place it as close as possible to the V_p pin.

Shutdown Function

The device enters in shutdown mode when the shutdown signal is low. During the shutdown mode, the DC quiescent current of the circuit does not exceed 1 μ A. In this configuration, the output impedance is 20 k Ω on each output.

Layout Recommendation

Connect C1 as close as possible to the V_p pin.

Connect C2 and C3 as close as possible to the NCP2815.

Route the audio signal and SGND far away from V_p, CPP, CPM, PVM and PGND to avoid any perturbation due to the switching.

NCP2815

ORDERING INFORMATION

Device	Package	Shipping†
NCP2815AFCT2G	CSP – 12 – 1.6 x 1.2 mm (Pb-Free)	3000 / Tape & Reel
NCP2815BFCT2G	CSP – 12 – 1.6 x 1.2 mm (Pb-Free)	3000 / Tape & Reel
NCP2815BFCCT2G	CSP – 12 – 1.6 x 1.2 mm (Backside laminate coating) (Pb-Free)	3000 / Tape & Reel

†For information on tape and reel specifications, including part orientation and tape sizes, please refer to our Tape and Reel Packaging Specifications Brochure, BRD8011/D.

MECHANICAL CASE OUTLINE

PACKAGE DIMENSIONS

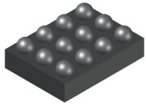

WLCSP12 1.62x1.22x0.539
CASE 499BJ
ISSUE D

DATE 02 JUN 2022

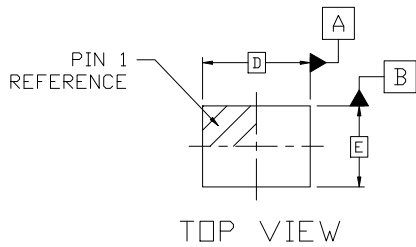

TOP VIEW

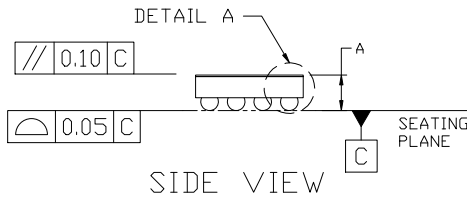

SIDE VIEW

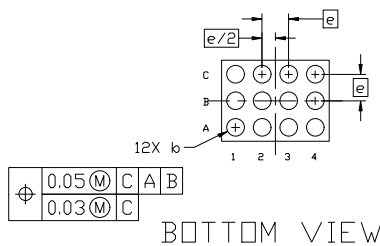

BOTTOM VIEW

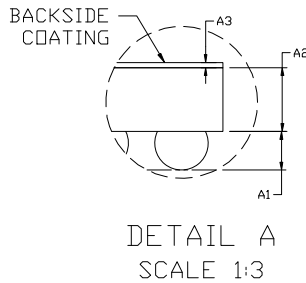

DETAIL A
SCALE 1:3

NOTES:

1. DIMENSIONING AND TOLERANCING PER ASME Y14.5M, 2009.
2. CONTROLLING DIMENSION: MILLIMETERS
3. DIMENSION *b* IS MEASURED AT THE MAXIMUM SOLDER BALL DIAMETER PARALLEL TO DATUM C.
4. COPLANARITY APPLIES TO THE SPHERICAL CROWNS OF THE SOLDER BALLS.
5. DATUM C, THE SEATING PLANE, IS DEFINED BY THE SPHERICAL CROWNS OF THE SOLDER BALLS.

DIM	MILLIMETERS		
	MIN.	NOM.	MAX.
A	0.484	0.539	0.594
A1	0.164	0.194	0.224
A2	0.295	0.320	0.345
A3	0.025 BSC		
<i>b</i>	0.239	0.269	0.299
D	1.62 BSC		
E	1.22 BSC		
<i>e</i>	0.40 BSC		

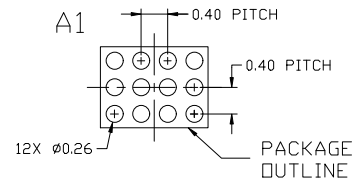

RECOMMENDED
MOUNTING FOOTPRINT*

GENERIC MARKING DIAGRAM*

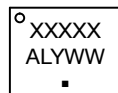

- XXXXX = Specific Device Code
- A = Assembly Location
- L = Wafer Lot
- Y = Year
- WW = Work Week
- = Pb-Free Package

*This information is generic. Please refer to device data sheet for actual part marking. Pb-Free indicator, "G" or microdot "▪", may or may not be present. Some products may not follow the Generic Marking.

* For additional information on our Pb-Free strategy and soldering details, please download the ON Semiconductor Soldering and Mounting Techniques Reference Manual, SOLDERRM/D.

DOCUMENT NUMBER:	98AON48124E	Electronic versions are uncontrolled except when accessed directly from the Document Repository. Printed versions are uncontrolled except when stamped "CONTROLLED COPY" in red.
DESCRIPTION:	WLCSP12 1.62x1.22x0.539	PAGE 1 OF 1

onsemi and ONSEMI are trademarks of Semiconductor Components Industries, LLC dba onsemi or its subsidiaries in the United States and/or other countries. onsemi reserves the right to make changes without further notice to any products herein. onsemi makes no warranty, representation or guarantee regarding the suitability of its products for any particular purpose, nor does onsemi assume any liability arising out of the application or use of any product or circuit, and specifically disclaims any and all liability, including without limitation special, consequential or incidental damages. onsemi does not convey any license under its patent rights nor the rights of others.

onsemi, **Onsemi**, and other names, marks, and brands are registered and/or common law trademarks of Semiconductor Components Industries, LLC dba "**onsemi**" or its affiliates and/or subsidiaries in the United States and/or other countries. **onsemi** owns the rights to a number of patents, trademarks, copyrights, trade secrets, and other intellectual property. A listing of **onsemi**'s product/patent coverage may be accessed at www.onsemi.com/site/pdf/Patent-Marking.pdf. **onsemi** reserves the right to make changes at any time to any products or information herein, without notice. The information herein is provided "as-is" and **onsemi** makes no warranty, representation or guarantee regarding the accuracy of the information, product features, availability, functionality, or suitability of its products for any particular purpose, nor does **onsemi** assume any liability arising out of the application or use of any product or circuit, and specifically disclaims any and all liability, including without limitation special, consequential or incidental damages. Buyer is responsible for its products and applications using **onsemi** products, including compliance with all laws, regulations and safety requirements or standards, regardless of any support or applications information provided by **onsemi**. "Typical" parameters which may be provided in **onsemi** data sheets and/or specifications can and do vary in different applications and actual performance may vary over time. All operating parameters, including "Typicals" must be validated for each customer application by customer's technical experts. **onsemi** does not convey any license under any of its intellectual property rights nor the rights of others. **onsemi** products are not designed, intended, or authorized for use as a critical component in life support systems or any FDA Class 3 medical devices or medical devices with a same or similar classification in a foreign jurisdiction or any devices intended for implantation in the human body. Should Buyer purchase or use **onsemi** products for any such unintended or unauthorized application, Buyer shall indemnify and hold **onsemi** and its officers, employees, subsidiaries, affiliates, and distributors harmless against all claims, costs, damages, and expenses, and reasonable attorney fees arising out of, directly or indirectly, any claim of personal injury or death associated with such unintended or unauthorized use, even if such claim alleges that **onsemi** was negligent regarding the design or manufacture of the part. **onsemi** is an Equal Opportunity/Affirmative Action Employer. This literature is subject to all applicable copyright laws and is not for resale in any manner.

PUBLICATION ORDERING INFORMATION

LITERATURE FULFILLMENT:

Email Requests to: orderlit@onsemi.com

onsemi Website: www.onsemi.com

TECHNICAL SUPPORT

North American Technical Support:

Voice Mail: 1 800-282-9855 Toll Free USA/Canada

Phone: 011 421 33 790 2910

Europe, Middle East and Africa Technical Support:

Phone: 00421 33 790 2910

For additional information, please contact your local Sales Representative